

USER MANUAL

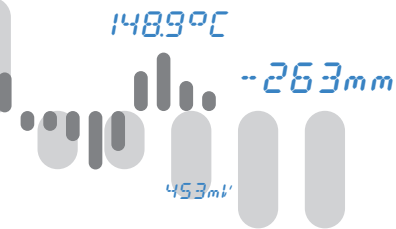

OMD 202UNI - B

4/6 DIGIT PROGRAMMABLE
LARGE DISPLAY

DC VOLTMETER/AMMETER
PROCESS MONITOR
OHMMETER

THERMOMETER FOR PT 100/500/1 000

THERMOMETER FOR NI 1 000

THERMOMETER FOR THERMOCOUPLES

DISPLAYS FOR LIN. POTENTIOMETERS



Outstanding Measurement Value

SAFETY INSTRUCTIONS

Please read carefully the enclosed safety instructions and observe them!

Installation, all operational interventions, maintenance and service must be performed by a qualified personnel and in accordance with the attached information and safety regulations. The manufacturer is not liable for damage caused by improper installation, configuration, maintenance, and service.

The recorder must be installed according to the respective application. Incorrect installation can cause a malfunction, which can result in damage or accident.

The recorder uses dangerous voltages that can cause a fatal accident. Before you start solving problems (e.g. in TIMEe of failure or disassembly), the device must be disconnected from the power supply. For safety information the EN 61 010-1 + A2 standard must be observed.

When removing or inserting a card, observe the safety instructions and follow the recommended procedure. During any intervention the recorder must be disconnected from the power supply.

Do not attempt to repair or modify the device. A defective recorder must be sent for repair to the manufacturer.

These devices should be safeguarded by isolated or common fuses (breakers)!

The recorder is not designed for installation in potentially explosive surroundings (Ex). Use it only outside potentially explosive surroundings

TECHNICAL DATA

Measuring instruments of the OMD 202 series conform to the European regulation 2014/30/EU and 2014/35/EU

The instruments are up to the following European standards

EN 61010-1	Electrical safety
EN 61326-1	Electronic measuring, control and laboratory devices - Requirements for EMC "Industrial use"

The recorders are applicable for unlimited use in agricultural and industrial areas.

ORBIT MERRET, spol. s r.o.

Vodňanská 675/30
198 00 Praha 9
Czech republic

Tel: +420 - 281 040 200
Fax: +420 - 281 040 299
orbit@merret.eu
www.orbit.merret.eu



1. CONTENTS	3
2. INSTRUMENT DESCRIPTION	4
3. INSTRUMENT CONNECTION	6
Measuring ranges	6
Termination of RS 485 communication line	6
Instrument connection	7
Recommended connection of sensors	8
4. INSTRUMENT SETTING	10
Symbols used in the instructions	12
Setting the DP and the (-) sign	12
Control keys function	13
Setting/permitting items into "USER" menu	13
5. SETTING "LIGHT" MENU	14
5.0 Description "LIGHT" menu	14
Setting input - Type "DC"	18
Setting input - Type "PM"	18
Setting input - Type "OHM"	19
Setting input - Type "RTD - Pt"	20
Setting input - Type "RTD - Ni"	21
Setting input - Type "T/C"	22
Setting input - Type "DU"	36
Setting input - Type "RTD - Cu"	24
Setting measuring range for Channels B, C, D	24
Setting display colors	38
Setting projection for Channel B	40
Setting projection for Channel B	42
Setting projection for Channel B	44
Setting Limits	46
Setting analog output	48
Setting the address of IR remote control	50
Selection of programming menu „LIGHT"/„PROFI"	50
Restoration of manufacture setting	51
Calibration - input range (DU)	52
Selection of instrument menu language version	53
Setting new access password	53
Instrument identification	53
6. SETTING "PROFI" MENU	54
6.0 Description of "PROFI" menu	58
6.1 "PROFI" menu - INPUT	
6.1.1 Resetting internal values	58
6.1.2 Setting measuring type, range, mode, rate, ...	59
6.1.3 Setting the Real Time	66
6.1.4 External input function selection	66
6.1.5 Optional accessory functions of the keys	68
6.2 "PROFI" menu - CHANNEL	
6.2.1 Setting measuring parameters (projection, filters, decimal point, description)	72
6.2.2 Setting mathematic functions	76
6.2.3 Selection of evaluation of min/max. value	81
6.3 "PROFI" menu - OUTPUT	
6.3.1 Selection of excitation	83
6.3.2 Setting Limits	83
6.3.3 Setting data output	87
6.3.4 Setting analog output	88
6.3.5 Selection of display projection	90
6.4 "PROFI" menu - SERVICE	
6.4.1 Setting the address of IR remote control	92
6.4.2 Selection of programming menu „LIGHT"/„PROFI"	93
6.4.3 Restoration manufacture setting	93
6.4.4 Calibration - input range (DU)	94
6.4.5 Selection of instr. menu language version	95
6.4.6 Setting new access password	95
6.4.7 Instrument identification	95
7. SETTING ITEMS INTO "USER" MENU	96
8. METHOD OF MEASURING OF THE COLD JUNCTION	98
9. DATA PROTOCOL	99
10. ERROR STATEMENTS	101
11. TABLE OF SYMBOLS	102
12. INSTRUMENT DIMENSIONS AND INSTALATION ..	103
13. TECHNICAL DATA	104
14. CERTIFICATE OF GUARANTEE	106

2. INSTRUMENT DESCRIPTION

2.1 DESCRIPTION

The OMD 202 model series are 4/6 digit large panel programmable displays designed for maximum efficiency and user comfort while maintaining their favourable price. It comes either with a 3-colour LED display (red/green/orange) or with High Brightness LEDs (red or green with brightness of 1 300 mcd).

Type OMD 202UNI is a multifunction instrument with the option of configuration for 8 various input options, easily configurable in the instrument menu. By further options of input modules it is feasible to measure larger ranges of DC voltage and current or increase the number of inputs up to 4 (applies for PM).

The instrument is based on an 8-bit microcontroller with a multichannel 24-bit sigma-delta converter, which secures high accuracy, stability and easy operation of the instrument.

THE OMD 202 IS A MULTIFUNCTION INSTRUMENT AVAILABLE IN FOLLOWING TYPES AND RANGES

UNI	DC: 0...60/150/300/1200 mV PM: 0...5 mA/0...20 mA/4...20 mA/±2 V/±5 V/±10 V/±40 V OHM: 0...100 Ω/0...1 kΩ/0...10 kΩ/0...100 kΩ RTD-Pt: Pt 50/100/Pt 500/Pt 1000 RTD-Cu: Cu 50/Cu 100 RTD-Ni: Ni 1 000/Ni 10 000 T/C: J/K/T/E/B/S/R/N/L DU: Linearn potentiometers (min. 500 Ω)
UNI - A	DC: ±0,1±0,1 A/±0,25 A/±0,5 A/±2 A/±5 A/±100 V/±250 V/±500 V
UNI - B	PM: 3x 0...5 mA/0...20 mA/4...20 mA/±2 V/±5 V/±10 V/±40 V

PROGRAMMABLE PROJECTION

Selection:	of type of input and measuring range
Measuring range:	adjustable as fixed or with automatic change
Setting:	manual, optional projection on the display may be set in the menu for both limit values of the input signal, e.g. input 0...20 mA > 0...850,0
Projection:	-9999...9999 (-99999...999999)

COMPENSATION

of conduct:	in the menu it is possible to perform compensation for 2-wire connection
of conduct in probe:	internal connection (conduct resistance in measuring head)
of CJC (T/C):	manual or automatic, in the menu it is possible to perform selection of the type of thermocouple and compensation of cold junctions, which is adjustable or automatic(temperature at the brackets)

LINEARIZATION

Linearization*:	by linear interpolation in 50 points (solely via OM Link)
-----------------	---

DIGITAL FILTERS

Floating average:	from 2...30 measurements
Exponen.average:	from 2...100 measurements
Rounding:	setting the projection step for display

MATHEMATIC FUCTIONS

Min/max. value:	registration of min./max. value reached during measurement
Tare:	designed to reset display upon non-zero input signal
Peak value:	the display shows only max. or min. value
Mat. operations:	polynome, 1/x, logarithm, exponential, power, root, sin x

* only for types DC, PM, DU

EXTERNAL CONTROL

Lock:	control keys blocking
Hold:	display/instrument blocking
Tare:	tare activation/resetting tare to zero
Resetting MM:	resetting min/max value

2.2 OPERATION

The instrument is set and controlled by IR Remote control. All programmable settings of the instrument are performed in three adjusting modes:

LIGHT	Simple programming menu - contains solely items necessary for instrument setting and is protected by optional number code
PROFI	Complete programming menu - contains complete instrument menu and is protected by optional number code
USER	User programming menu - may contain arbitrary items selected from the programming menu (LIGHT/PROFI), which determine the right (see or change) - acces without password

All programmable parameters are stored in the EEPROM memory (they hold even after the instrument is switched off).

OMLINK Complete instrument operation and setting may be performed via OM Link communication interface, which is a standard equipment of all instruments.

The operation program is freely accessible (www.orbit.merret.eu) and the only requirement is the purchase of OML cable to connect the instrument to PC. It is manufactured in version RS 232 and USB and is compatible with all ORBIT MERRET instruments. Another option for connection is with the aid of data output RS 232 or RS 485 (without the need of the OML cable).

The program OM LINK in „Basic“ version will enable you to connect one instrument with the option of visualization and archiving in PC. The OM Link „Standard“ version has no limitation of the number of instruments connected.

2.3 OPTIONS

Excitation is suitable for supplying power to sensors and transmitters. It has a galvanic separation.

Comparators are assigned to monitor one, two, three or four limit values with relay output. The user may select limits regime: LIMIT/DOSING/FROM-TO. The limits have adjustable hysteresis within the full range of the display as well as selectable delay of the switch-on in the range of 0..99,9 s. Reaching the preset limits is signalled by LED and simultaneously by the switch-on of the relevant relay.

Data outputs are for their rate and accuracy suitable for transmission of the measured data for further projection or directly into the control systems. We offer an isolated RS232 and RS485 with the ASCII or DIN MessBus protocol.

Analog outputs will find their place in applications where further evaluating or processing of measured data is required in external devices. We offer universal analog output with the option of selection of the type of output - voltage/current. The value of analog output corresponds with the displayed data and its type and range are selectable in Menu.

3. INSTRUMENT CONNECTION

The instrument supply leads should not be in proximity of the incoming low-potential signals.

Contactors, motors with larger input power should not be in proximity of the instrument.

The leads into the instrument input (measured quantity) should be in sufficient distance from all power leads and appliances. Provided this cannot be secured it is necessary to use shielded leads with connection to ground (bracket E).

The instruments are tested in compliance with standards for use in industrial area, yet we recommend to abide by the above mentioned principles.

MEASURING RANGES

TYPE	INPUT I	INPUT U
DC		0...60/150/300/1 200 mV
PM	0...5/20 mA/4...20 mA	±2/±5/±10/±40 V
OHM	0...100 Ω/1 kΩ/10 kΩ/100 kΩ	
RTD-Pt	Pt 50/100/Pt 500/ Pt 1 000	
RTD-Cu	Cu 50/100	
RTD-Ni	Ni 1 000/10 000	
T/C	J/K/T/E/B/S/R/N/L	
DU	Linear potentiometer (min. 500 Ω)	

OPTION "A"

TYPE	INPUT I	INPUT U
DC	±0,1 A/±0,25 A/±0,5 A proti GND (C) ±2 A/±5 A proti GND (B)	±100 V/±250 V/±500 V proti GND (C)

OPTION "B"

TYPR	INPUTS 2, 3, 4/I	INPUTS 2, 3, 4/U
PM	0...5/20 mA/4...20 mA	±2/±5/±10/±40 V

Termination of RS 485 communication line

X3 - Termination of communication line RS 485

Full	Significance	Default	Recommendation
1-2	connect L+ to (+) source	terminalconnected	connect at the end of line do not disconnect
3-4	termination of line 120 Ohm	disconnected	
5-6	connect L- to (-) source	terminalconnected	

RS 485 line should have a linear structure - wires (ideally shielded and twisted) should lead from one device to another.

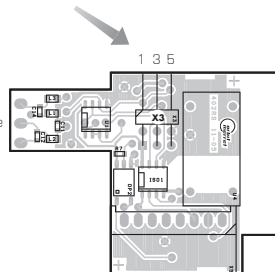

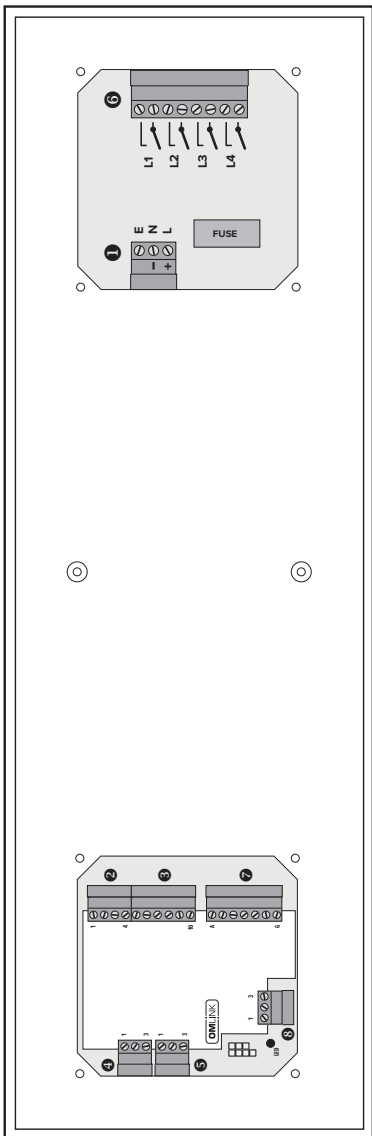

- 1** Analogue output*
 - AO-U
 - AO-I
 - GND
- 2** Data output*
 - B/D-L
 - T/D-L
 - GND
- 3** OMA Time*
 - Signal
 - Signal
 - Shielding
- 4** External inputs
 - EXT.1
 - EXT.2
 - EXT.3
- 5** Input
 - RFD, OMA, NI
 - DC, PM
 - Excitation
 - GND
 - INPUT-1
 - INPUT-U
- 6** Relays*
 - E
 - N
 - L
- 7** Power supply
 - E
 - N
 - L



Maximum of 250 mA may be connected to "INPUT - I" (bracket no. 8), i.e. 10-times range overload.
Mind the correct connection/mistaking of current - voltage input.
Destruction of measuring resistance in current input (15R) may occur.

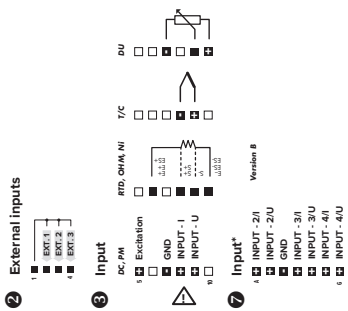

3. INSTRUMENT CONNECTION

Example connection of a 2-wire sensor with current signal output powered by instrument's excitation

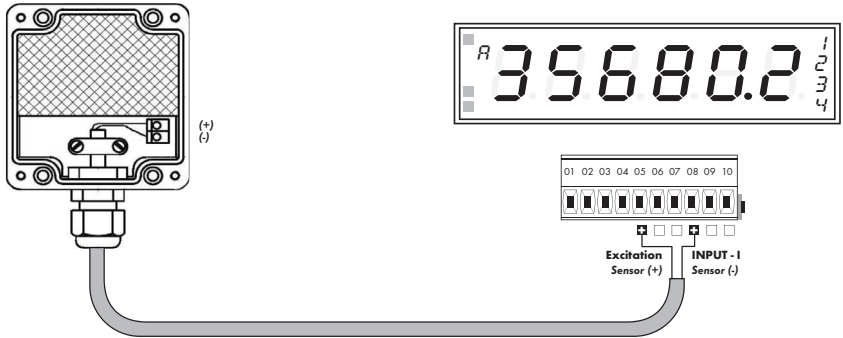

Example connection of a 3-wire sensor with current signal output powered by instrument's excitation

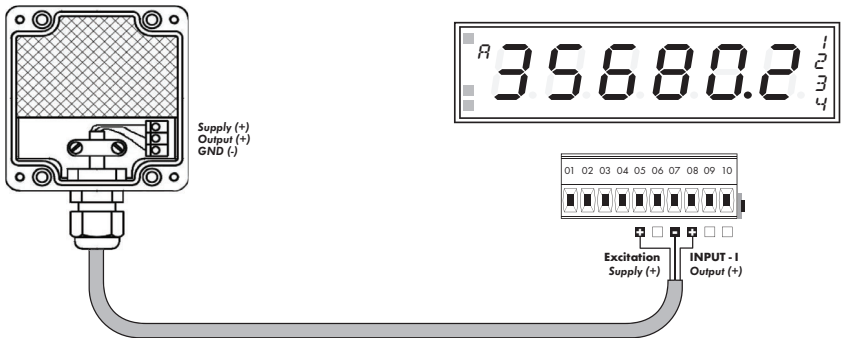

Example connection of 3-wire sensor with voltage signal output powered by instrument's excitation

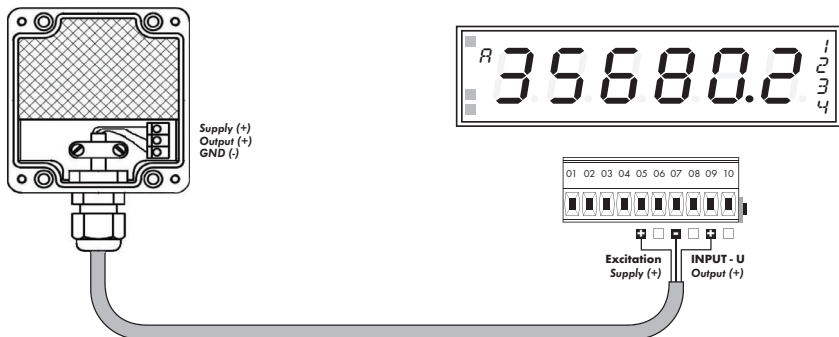

Example connection of resistance measurement using 4 wires

By connecting resistor R* we eliminate error message E. I.O.V. (input overflow) when the measured resistance is disconnected

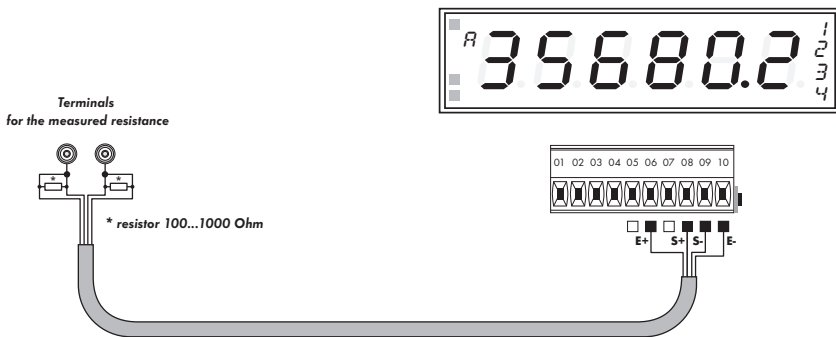

SETTING PROFI

For expert users

Complete instrument menu

Access is password protected

Possibility to arrange items of the **USER MENU**

Tree menu structure

SETTING LIGHT

For trained users

Only items necessary for instrument setting

Access is password protected

Possibility to arrange items of the **USER MENU**

Linear menu structure

SETTING USER

For user operation

Menu items are set by the user (Profi/Light) as per request

Access is not password protected

Optional menu structure either tree (PROFI) or linear (LIGHT)

4.1 SETTING

The instrument is set and controlled by IR Remote control. All programmable settings of the instrument are performed in three adjusting modes:

- LIGHT** **Simple programming menu**
- contains solely items necessary for instrument setting and is protected by optional number code
- PROFI** **Complete programming menu**
- contains complete instrument menu and is protected by optional number code
- USER** **User programming menu**
- may contain arbitrary items selected from the programming menu (LIGHT/PROFI), which determine the right (see or change)
- access without password

Complete instrument operation and setting may be performed via OM Link communication interface, which is a standard equipment of all instruments.

The operation program is freely accessible (www.orbit.merret.eu) and the only requirement is the purchase of OML cable to connect the instrument to PC. It is manufactured in version RS 232 and USB and is compatible with all ORBIT MERRET instruments. Another option for connection is with the aid of data output RS 232 or RS 485 (without the need of the OML cable).

Scheme of processing the measured signal

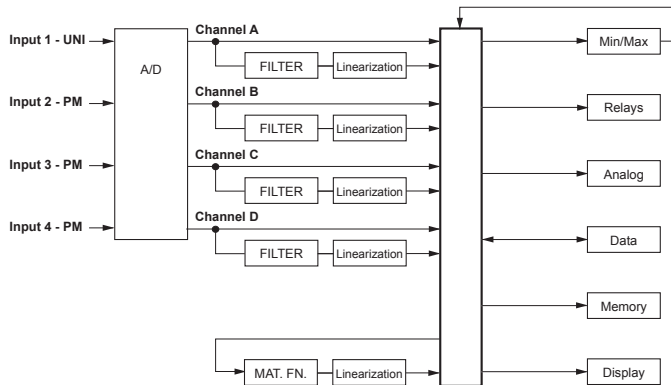

4. INSTRUMENT SETTING

Setting and controlling the instrument is performed by means of the Remote control. With the aid of the Remote control it is possible to browse through the operation menu and to select and set the required values.

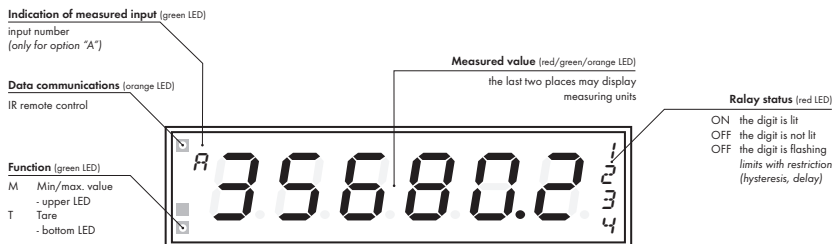

Symbols used in the instructions



DU OHM RTD T/C Indicates the setting for given type of instrument

DEF values preset from manufacture

symbol indicates a flashing light (symbol)

inverted triangle indicates the item that can be placed in USER menu

broken line indicates a dynamic item, i.e. it is displayed only in particular selection/version

after pressing the key the set value will not be stored

after pressing the key the set value will be stored

30 continues on page 30

Setting the decimal point and the minus sign

DECIMAL POINT

Its selection in the menu, upon modification of the number to be adjusted it is performed by the control key with transition beyond the highest decade, when the decimal point starts flashing . Positioning is performed by .

THE MINUS SIGN

Setting the minus sign is performed by the key on higher decade. When editing the item subtraction must be made from the current number (e.g.: 013 > , on class 100 > -87)

Control keys functions

KEY	MEASUREMENT	MENU	SETTING NUMBERS/SELECTION
	access into USER menu	exit menu	quit editing
	programmable key function	back to previous level	move to higher decade*
	programmable key function	move to previous item	move down*
	programmable key function	move to next item	move up*
	programmable key function	confirm selection	confirm setting/selection
	access into LIGHT/PROFI menu		
>3 s 	direct access into PROFI menu		
		configuration of an item for "USER" menu	
		determine the sequence of items in "USER - LIGHT" menu	
	cancellation of address instrument/remote controller		

* alternatively, the setting may be done from the numeric keys of the remote control by selecting directly the number required

Setting items into „USER" menu

- in **LIGHT** or **PROFI** menu
- no items permitted in **USER** menu from manufacture
- on items marked by inverted triangle

USER

legend is flashing - current setting is displayed



item will not be displayed in USER menu

item will be displayed in USER menu with the option of setting

item will be solely displayed in USER menu

SETTING LIGHT

For trained users

Only items necessary for instrument setting

Access is password protected

Possibility to arrange items of the **USER MENU**

Linear menu structure

Preset from manufacture

Password	"0"
Menu	LIGHT
USER menu	off
Setting the items	DEF

!

Upon delay exceeding 60s the programming mode is automatically discontinued and the instrument itself restores the measuring mode



Access password
 1428 PASS_w 0

Active inputs: InPUt5 4 InP Type of input - Channel A: tYPE 1 Pn Measuring range - Channel A: R0dE 1 4-20mA

RTD OHM
 COndEct 2-w IrE F0-rN.R 0000.0
 T/C
 COndEct EMt. ItC C.U tEN 23 F0-rN.R 0000.0
Selecting projection and connection

Measuring range - Channel B: R0dE 2 4-20mA
 Measuring range - Channel C: R0dE 3 4-20mA
 Measuring range - Channel D: R0dE 4 4-20mA

DC PA OHM DU Setting projection - Channel A
 n In A 0 nAR A 100 F0-rN.R 0000.0 Basic color: COL 0 A GrEE n

First color's limit: LIn 1 A 33.33 Color after first limit: COL 1 A 0-rARGE Second color's limit: LIn 2 A 66.67 Color after second limit: COL 2 A rEd

Setting projection - Channel B
 n In b 0 nAR b 100 F0-rN.b 0000.0 Basic color: COL 0 b GrEE n

Setting projection - Channel C
 n In C 0 nAR C 100 F0-rN.C 0000.0 Basic color: COL 0 C GrEE n

Setting projection - Channel D
 n In d 0 nAR d 100 F0-rN.d 0000.0 Basic color: COL 0 d GrEE n

LIn L1 20 LIn L2 40 LIn L3 60 LIn L4 80
Option - comparator

CYPE R0 120 n In R0 0 nAR R0 100
Option - Analog output

Menu type: nENU LIGHT Return to manufacture calibration: rE CARL YES Return to manufacture setting: rE SEt Fir n

DU Calibration - only for "DU"
 C n In YES C nAR YES Language selection: LAR0 EnGL New password: PAS L1 0

Identification: IdEnt 1 Instrument: 0Nd202Un1-b SW version Input: 78-001 4 InP 1428 Return to measuring mode

5. SETTING LIGHT

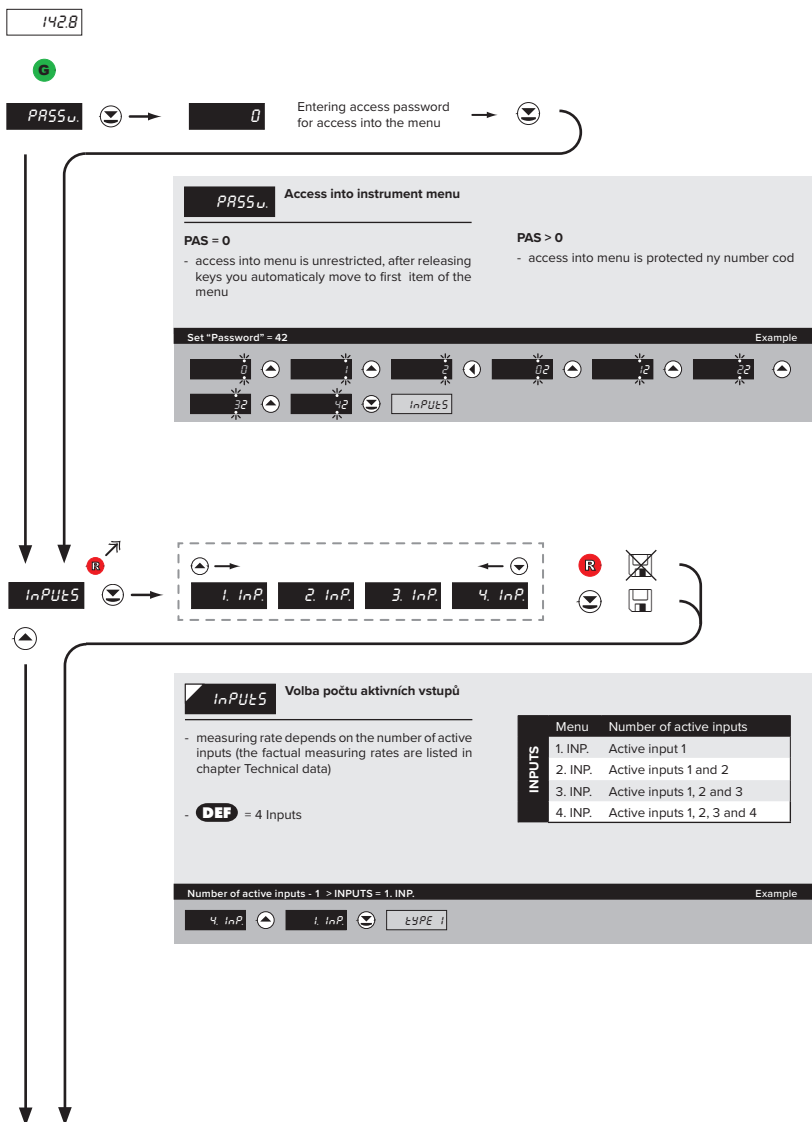

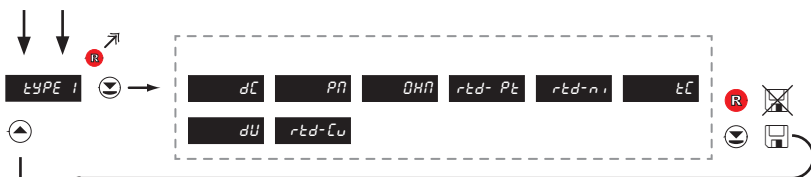

TYPE 1 Selection of the type of instrument

- primary selection of the type of instrument
- performs default setting **DEF** of values from manufacture, incl. calibration
- **DEF** = „PM“

Menu	Type of instrument
DC	DC voltmeter
PM	Process monitor
OHM	Ohmmeter
RTD-Pt	Thermometer for sensors Pt
RTD-Ni	Thermometer for sensors Ni
TC	Thermometer for thermocouples
DU	Display for lin. potentiometer
RTD-Cu	Thermometer for sensors Cu

Type "PM" Example

PM rtd-Cu

Type DC	18
Type PM	18
Type OHM	19
Type RTD-Pt	20
Type RTD-Ni	21
Type T/C	22
Type DU	36
Type RTD-Cu	24

5. SETTING LIGHT

CHANNEL A > MEASURING MODE > DC

nDdE 1

60 nV 150 nV 300 nV 1200 nV

nDdE 1 Selection of the instrument measuring range

DEF = 60 mV

MODE 1	Menu	Measuring range
	60 mV	±60 mV
	150 mV	±150 mV
	300 mV	±300 mV
	1200mV	±1.2 V

Range ±150 mV

Example

60 nV 150 nV nDdE 2

26

CHANNEL A > MEASURING MODE > PM

nDdE 1

0-5 nA 0-20 nA 4-20 nA ... 0-10 u 0-40 u Er4-20

nDdE 1 Selection of the instrument measuring range

DEF = 4 - 20 mA

MODE 1	Menu	Measuring range
	0-5mA	0...5 mA
	0-20mA	0...20 mA
	4-20mA	4...20 mA
	0-2 V	±2 V
	0-5 V	±5 V
	0-10 V	±10 V
	0-40 V	±40 V
	Er4-20	4...20 mA, with error statement of „underfl ow“ upon signal smaller than 3,36 mA

Range 0...20 mA

Example

4-20 nA 0-2 u nDdE 2

26



MODE 1 Selection of the instrument measuring range

DEF = 100 Ω

Menu	Measuring range
100 R	0...100 Ω
1 k	0...1 kΩ
10 k	0...10 kΩ
100 k	0...100 kΩ

Range 0...10 kΩ Example

100 r 1 k 10 k 100 k

CONNECT Selection of the type of sensor connection

DEF = 2-wire

Menu	Connection
2-WIRE	2-wire
3-WIRE	3-wire
4-WIRE	4-wire

Type of connection - 3 wire > CONNECT = 3-WIRE Example

2-wire 3-wire 4-wire

MODE 1

CONNECT

26

5. SETTING LIGHT

CHANNEL A > MEASURING MODE > RTD - Pt

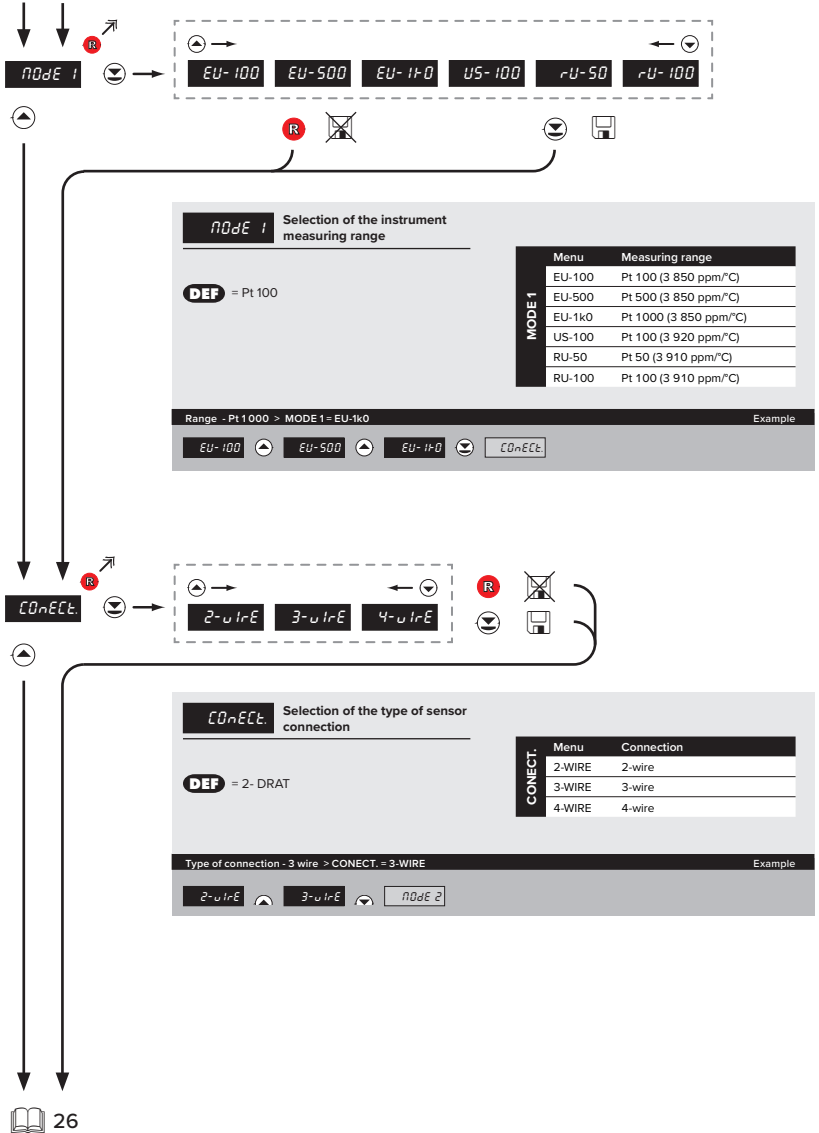



MODE 1 Selection of the instrument measuring range

DEF = Ni 1 000 - 5 000 ppm/°C

MODE 1	Menu	Measuring range
	5.0-1k	Ni 1 000 (5 000 ppm/°C)
	6.2-1k	Ni 1 000 (6 180 ppm/°C)
	5.0-10k	Ni 10 000 (5 000 ppm/°C)
	6.2-10k	Ni 10 000 (6 180 ppm/°C)

Range - Ni 10 000, 5 000 ppm > MOD = 5.0-10k Example

5.0-1k 6.2-1k 5.0-10k CONECT

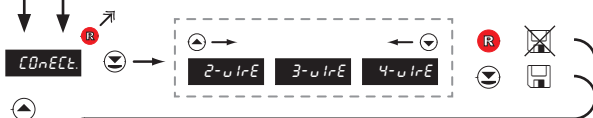

CONNECT Selection of the type of sensor connection

DEF = 2-WIRE

CONNECT	Menu	Connection
	2-WIRE	2-wire
	3-WIRE	3-wire
	4-WIRE	4-wire

Type of connection - 3 wire > CONECT. = 3-WIRE Example

2-wire 3-wire MODE 2

5. SETTING LIGHT

CHANNEL A > MEASURING MODE > T/C

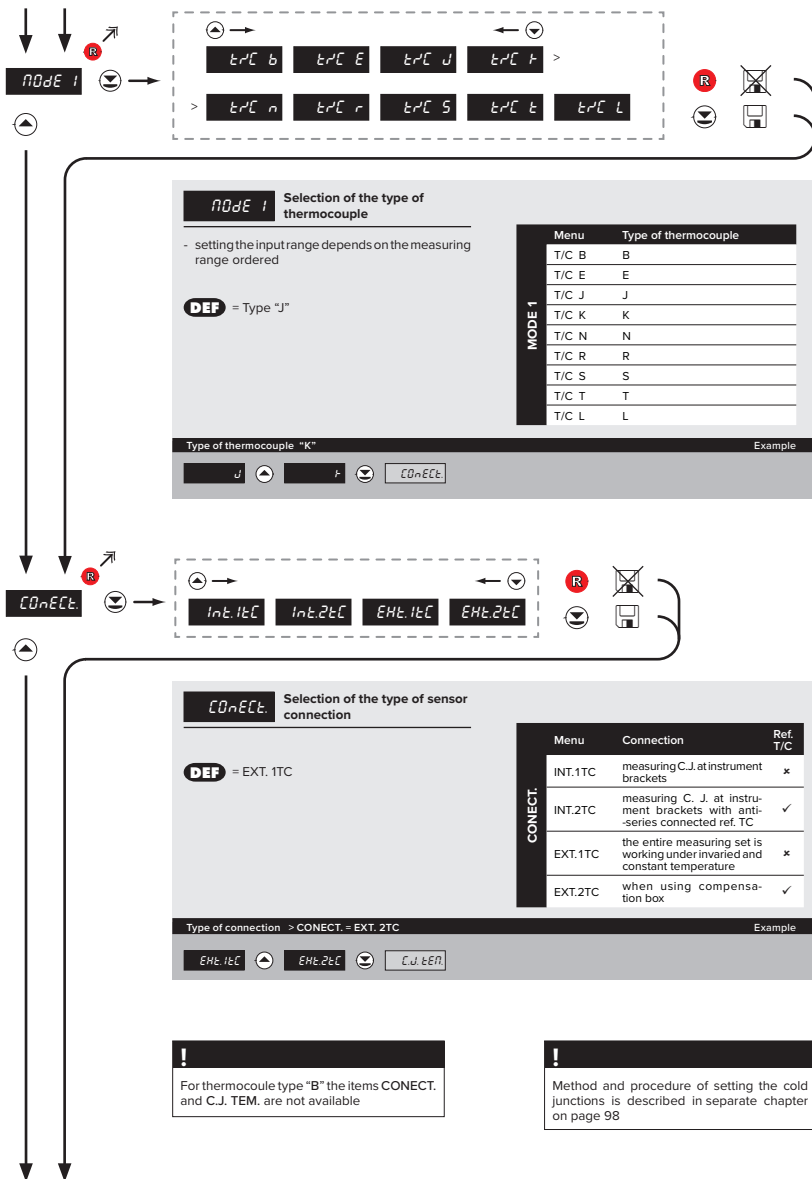

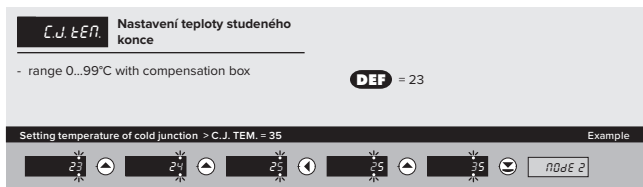
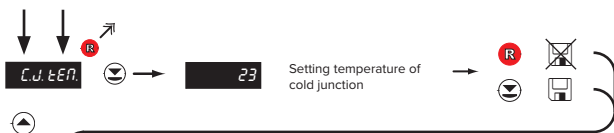

↕ ↕

📖 26

5. SETTING LIGHT

CHANNEL A > MEASURING MODE > RTD-Cu

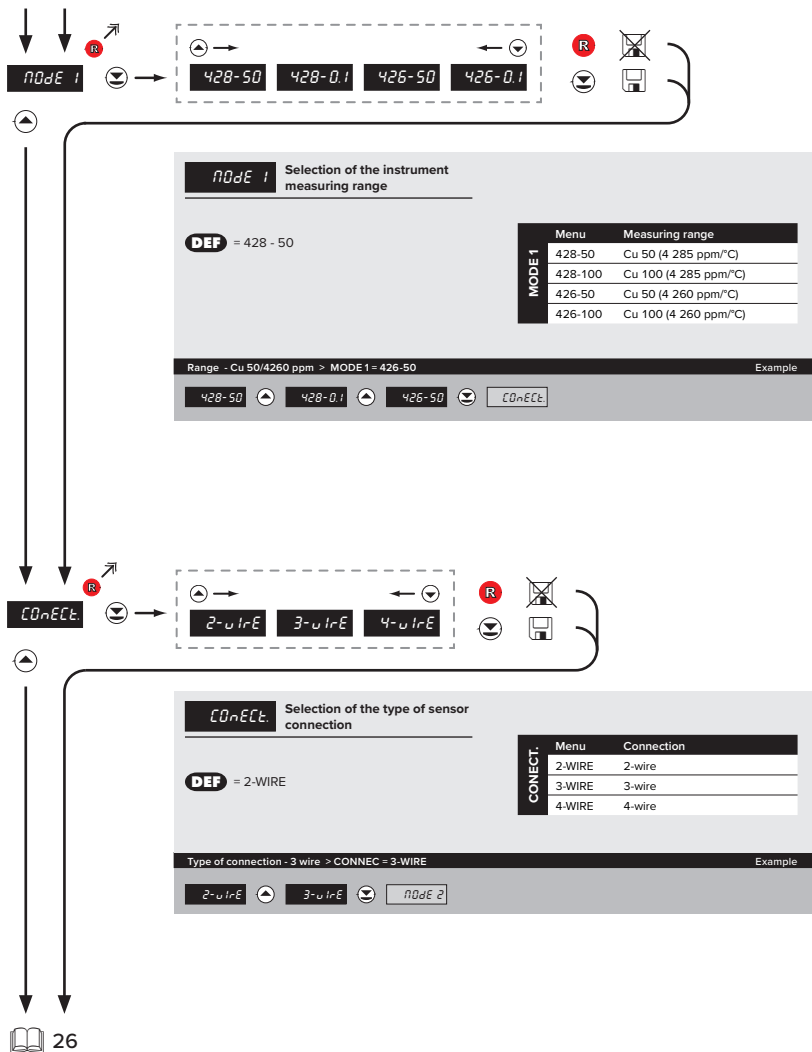



SETTING LIGHT 5.

5. SETTING LIGHT

CHANNEL B/C/D > MEASURING MODE > PM

The diagram illustrates the navigation path for setting the instrument measuring range. It starts from the main menu (top left) and branches into two paths: one for MODE 2 and one for MODE 3.

MODE 2 Path:

- Starts at the main menu with **MODE 2** selected.
- Navigation leads to a menu with options: **0-5 nA**, **0-20 nA**, **4-20 nA**, ..., **0-10 u**, **0-40 u**, **Er4-20**.
- The selected screen shows:
 - MODE 2** Selection of the instrument measuring range
 - DEF** = 4 - 20 mA
 - Range 0...20 mA
 - Example: **4-20 nA**, **0-2 u**, **MODE 3**
- The right side of the screen displays a table of available ranges:

Menu	Measuring range
0-5mA	0...5 mA
0-20mA	0...20 mA
4-20mA	4...20 mA
0-2 V	±2 V
0-5 V	±5 V
0-10 V	±10 V
0-40 V	±40 V
Er4-20	4...20 mA, with error statement of „underfl ow“ upon signal smaller than 3.36 mA

MODE 3 Path:

- Starts at the main menu with **MODE 3** selected.
- Navigation leads to the same menu with options: **0-5 nA**, **0-20 nA**, **4-20 nA**, ..., **0-10 u**, **0-40 u**, **Er4-20**.
- The selected screen shows:
 - MODE 3** Selection of the instrument measuring range
 - DEF** = 4 - 20 mA
 - Range 0...20 mA
 - Example: **4-20 nA**, **0-2 u**, **MODE 4**
- The right side of the screen displays a table of available ranges:

Menu	Measuring range
0-5mA	0...5 mA
0-20mA	0...20 mA
4-20mA	4...20 mA
0-2 V	±2 V
0-5 V	±5 V
0-10 V	±10 V
0-40 V	±40 V
Er4-20	4...20 mA, with error statement of „underfl ow“ upon signal smaller than 3.36 mA

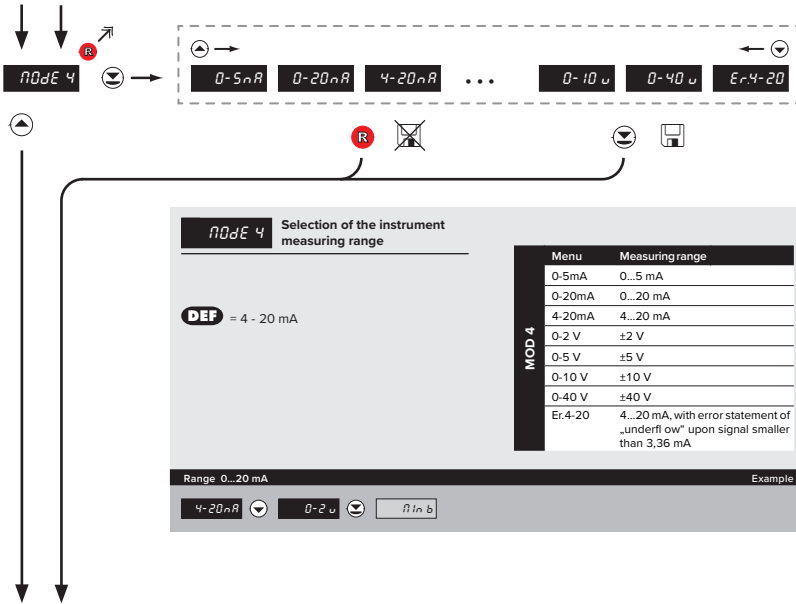

5. SETTING LIGHT

CHANNEL A > DC



nIn A Setting display projection for minimum value of input signal

- range of the setting is -99999...999999
- position of the DP does not affect display projection

- the DP is automatically shifted after the value is confirmed

DEF = 0

Projection for 0 mV > MIN A = 0 Example



nMax A Setting display projection for maximum value of input signal

- range of the setting is -99999...999999
- position of the DP does not affect display projection

- the DP is automatically shifted after the value is confirmed

DEF = 100

Projection for 150 mV > MAX A = 3500 Example

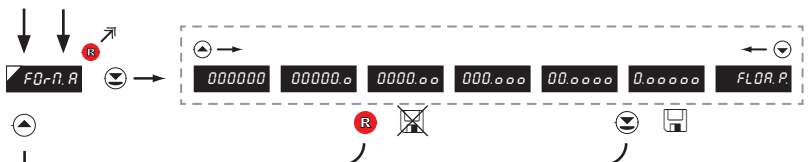

F0-r.R Setting projection of the decimal point

- positioning of the DP is set here in the measuring mode

DEF = 0000.00

Projection of DP on display > 00000.0 Example

0000.00 [down arrow] 00000.0 [down arrow] COLDR *subsequent item on the menu depends on instrument equipment

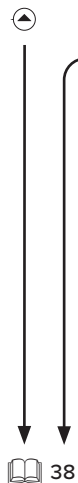

5. SETTING LIGHT

CHANNEL A ^ PM



Min A Setting display projection for minimum value of input signal

- range of the setting is -99999...999999
- position of the DP does not affect display projection

- the DP is automatically shifted after the value is confirmed

DEF = 0

Projection for 0 mA > MIN A = -25

Example

0	1	2	3	4	5
0.5	-5	-0.5	-1.5	-2.5	Min A



Max A Setting display projection for maximum value of input signal

- range of the setting is -99999...999999
- position of the DP does not affect display projection

- the DP is automatically shifted after the value is confirmed

DEF = 100

Projection for 20 mA > MAX A = 2500

Example

100	100	100	200	300	400
500	500	500	500	500	FO-A.R

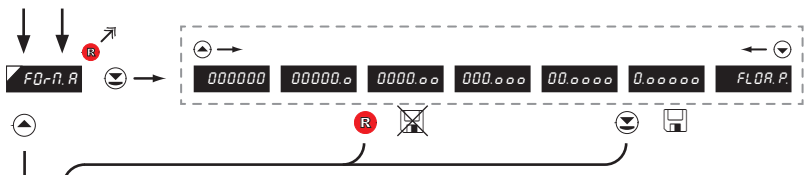

F0-r.R Setting projection of the decimal point

- positioning of the DP is set here in the measuring mode **DEF** = 0000.00

Projection of DP on display = 0000.00 Example

0000.00 COLD R *subsequent item on the menu depends on instrument equipment

38

5. SETTING LIGHT

CHANNEL A > OHM



nIn A Setting display projection for minimum value of input signal

- range of the setting is -99999...999999
- position of the DP does not affect display projection

- the DP is automatically shifted after the value is confirmed

DEF = 0

Projection for 0 Ohm > MIN A = 0 Example



nAh A Setting display projection for maximum value of input signal

- range of the setting is -99999...999999
- position of the DP does not affect display projection

- the DP is automatically shifted after the value is confirmed

DEF = 100

Projection for 10 kOhm > MAX A = 10000 Example

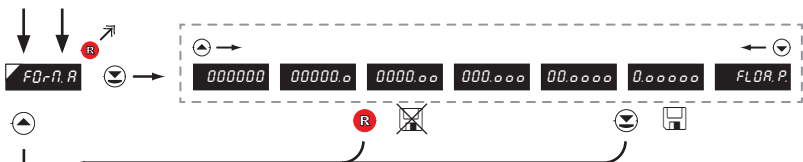

F0-r.A Setting projection of the decimal point

- positioning of the DP is set here in the measuring mode **DEF** = 0000.oo

Projection of DP on display > 00000.o Example

0000.o.o 00000.o 0000.o.o.o *subsequent item on the menu depends on instrument equipment

38

5. SETTING LIGHT

CHANNEL A > RTD - Pt



FD-r.N.A Setting projection of the decimal point

- positioning of the DP is set here in the measuring mode **DEF** = 00000.0

Projection of DP on display > 000000 Example

00000.0	000000	COLD R
---------	--------	--------

*subsequent item on the menu depends on instrument equipment

38

CHANNEL A > RTD - Ni



FD-r.N.A Setting projection of the decimal point

- positioning of the DP is set here in the measuring mode **DEF** = 00000.0

Projection of DP on display > 000000 Example

00000.0	000000	COLD R
---------	--------	--------

*subsequent item on the menu depends on instrument equipment

38



F0-r.A Setting projection of the decimal point

- positioning of the DP is set here in the measuring mode **DEP** = 00000.0

Projection of DP on display > 000000 Example

00000.0 000000 COLD R *subsequent item on the menu depends on instrument equipment



38

5. SETTING LIGHT

CHANNEL A > DU

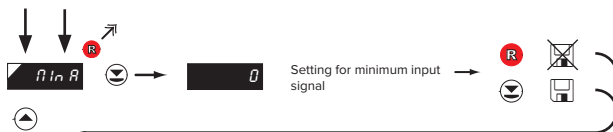

Min A Setting display projection for minimum value of input signal

- range of the setting is -99999...999999
- position of the DP does not affect display projection

- the DP is automatically shifted after the value is confirmed

DEF = 0

Projection for beginning > MIN A = 0 Example



Max A Setting display projection for maximum value of input signal

- range of the setting is -99999...999999
- position of the DP does not affect display projection

- the DP is automatically shifted after the value is confirmed

DEF = 100

Projection for end > MAX A = 5000 Example

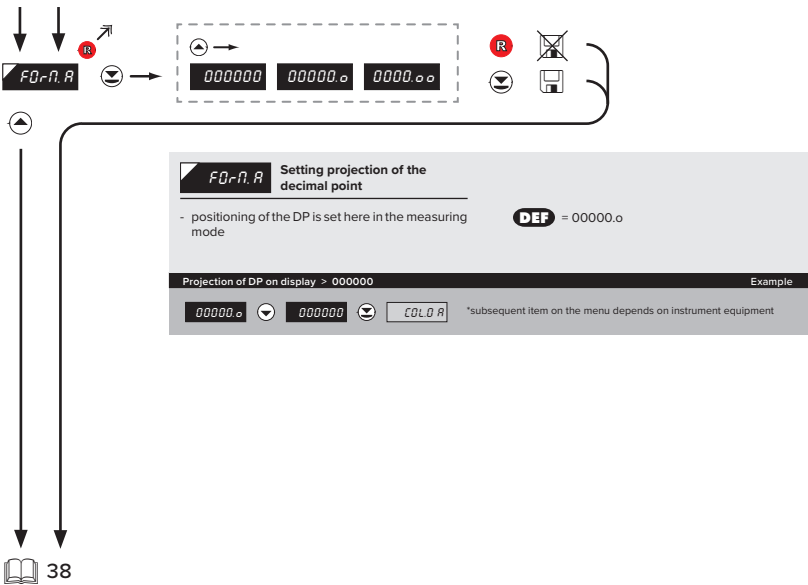
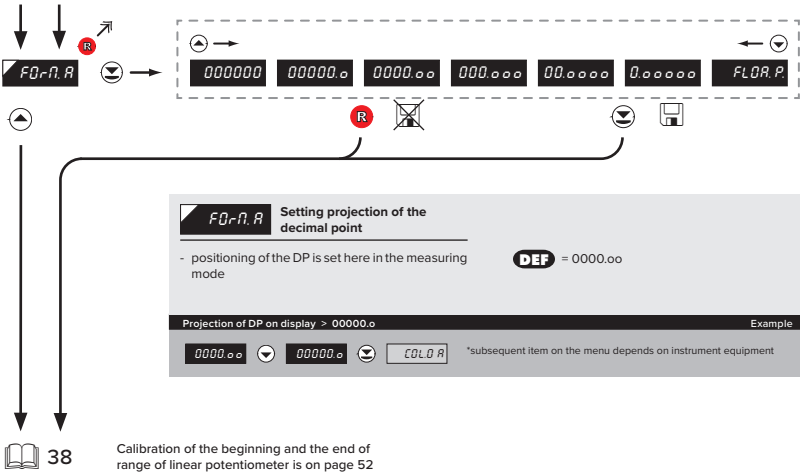

5. SETTING LIGHT

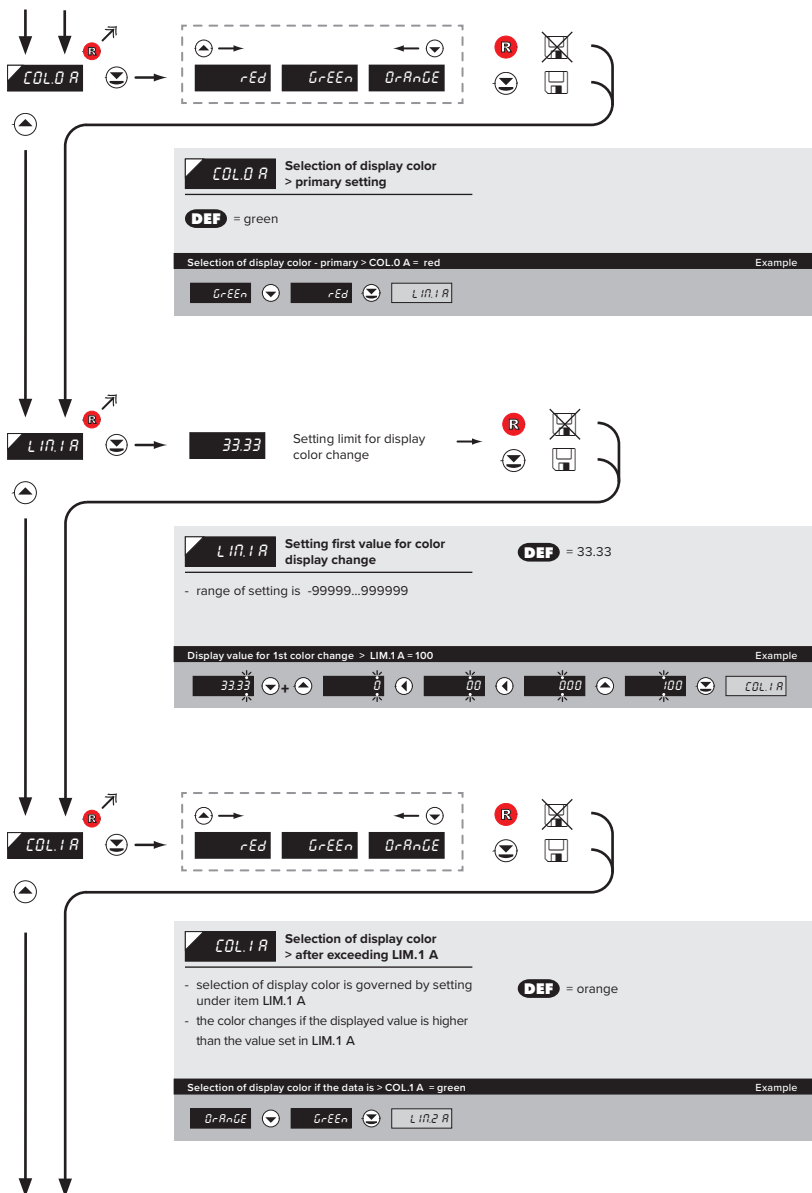

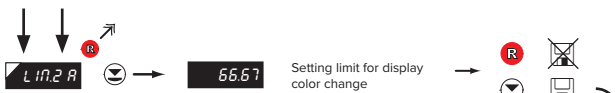

LIM.2 A Setting second value for display color change

- range of setting is -99999...999999 **DEF** = 66.67

Display value for 1st color change > LIM.2 A = 400 Example

66.67	0	00	000
200	300	400	COL.2 A



COL.2 A Volba barvy displeje > po překročení LIM.2 A **DEF** = červená

- selection of display color is governed by setting under item LIM.2 A

- the color changes if the displayed value is higher than the value set in LIM.2 A

Selection of display color if the data is > COL.2 A = orange Example

rEd	OrAnGE	A in b
-----	--------	--------

5. SETTING LIGHT

CHANNEL B
^
PM



Min b Setting display projection for minimum value of input signal

- range of the setting is -99999...999999
- position of the DP does not affect display projection

- the DP is automatically shifted after the value is confirmed

DEF = 0

Projection for 0 mA > MIN b = -25

Example

0	1	2	3	4	5	6	7	8	9
0.5	-5	-0.5	-1.5	-2.5	-3.5	-4.5	-5.5	-6.5	-7.5

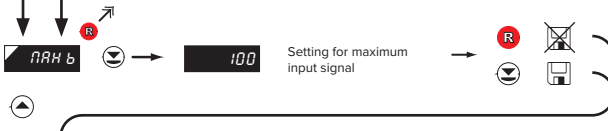

Max b Setting display projection for maximum value of input signal

- range of the setting is -99999...999999
- position of the DP does not affect display projection

- the DP is automatically shifted after the value is confirmed

DEF = 100

Projection for 20 mA > MAX b = 2500

Example

100	100	100	200	300	400
500	500	500	500	500	500

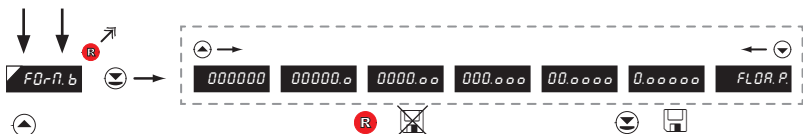

F0-r.b Setting projection of the decimal point

- positioning of the DP is set here in the measuring mode **DEP** = 0000.00

Projection of DP on display > 0000.00 Example

0000.00 *subsequent item on the menu depends on instrument equipment

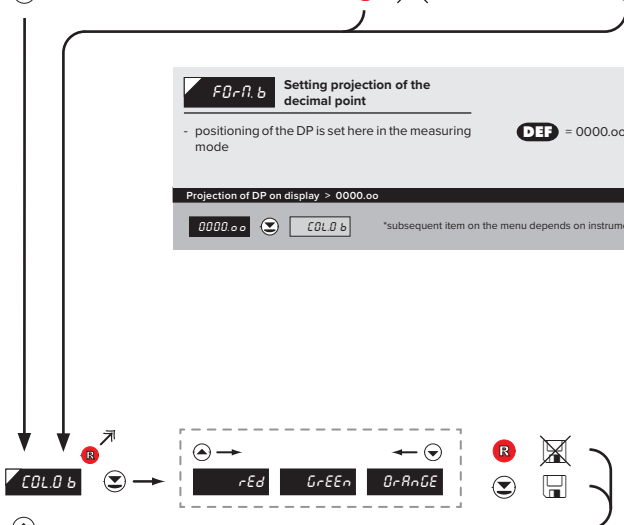

COL0 b Selection of display color > primary setting

DEP = green

Selection of display color - primary > COL0 B = red Example

GrEEen

Setting is identical as for "Channel A"

5. SETTING LIGHT

CHANNEL C
^
PM



Min C Setting display projection for minimum value of input signal

- range of the setting is -99999...999999
- position of the DP does not affect display projection

- the DP is automatically shifted after the value is confirmed

DEF = 0

Projection for 0 mA > MIN C = -25

Example

0	1	2	3	4	5	6	7	8	9
0.5	-5	-0.5	-1.5	-2.5	-3.5	-4.5	-5.5	-6.5	-7.5

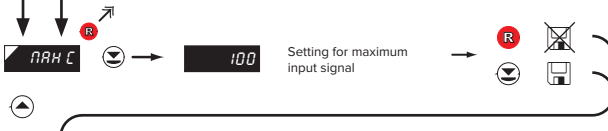

Max C Setting display projection for maximum value of input signal

- range of the setting is -99999...999999
- position of the DP does not affect display projection

- the DP is automatically shifted after the value is confirmed

DEF = 100

Projection for 20 mA > MAX C = 2500

Example

100	100	100	200	300	400
500	500	500	500	500	500

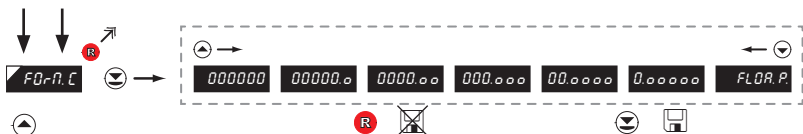

F0-R.C Setting projection of the decimal point

- positioning of the DP is set here in the measuring mode **DEP** = 0000.00

Projection of DP on display > 0000.00 Example

0000.00 **COLD.C** *subsequent item on the menu depends on instrument equipment



COLD.C Selection of display color > primary setting

DEP = green

Selection of display color - primary > COLD.C = red Example

GrEEen **rEd** **LIMIT**

Setting is identical as for "Channel A"

5. SETTING LIGHT

CHANNEL D ^ PM



Min d Setting display projection for minimum value of input signal

- range of the setting is -99999...999999
- position of the DP does not affect display projection

- the DP is automatically shifted after the value is confirmed

DEF = 0

Projection for 0 mA > MIN D = -25

Example

0	1	2	3	4	5	Min d
0.5	-5	-0.5	-1.5	-2.5		

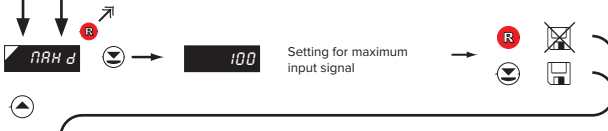

Max d Setting display projection for maximum value of input signal

- range of the setting is -99999...999999
- position of the DP does not affect display projection

- the DP is automatically shifted after the value is confirmed

DEF = 100

Projection for 20 mA > MAX D = 2500

Example

100	100	100	200	300	400	Max d
500	500	500	500	500		

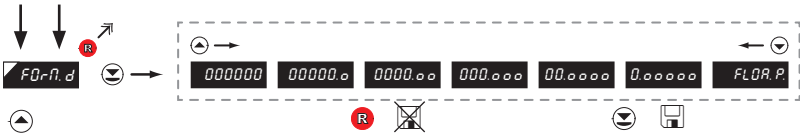

F0-r.d Setting projection of the decimal point

- positioning of the DP is set here in the measuring mode **DEP** = 0000.00

Projection of DP on display > 0000.00 Example

0000.00 **COL0 d** *subsequent item on the menu depends on instrument equipment



COL0 d Selection of display color > primary setting

DEP = green

Selection of display color - primary > COL0 D = red Example

GrEEen **rEd** Lin1 d

Setting is identical as for "Channel A"

5. SETTING LIGHT

DISPLAYED ONLY WITH OPTIONS > COMPARATORS

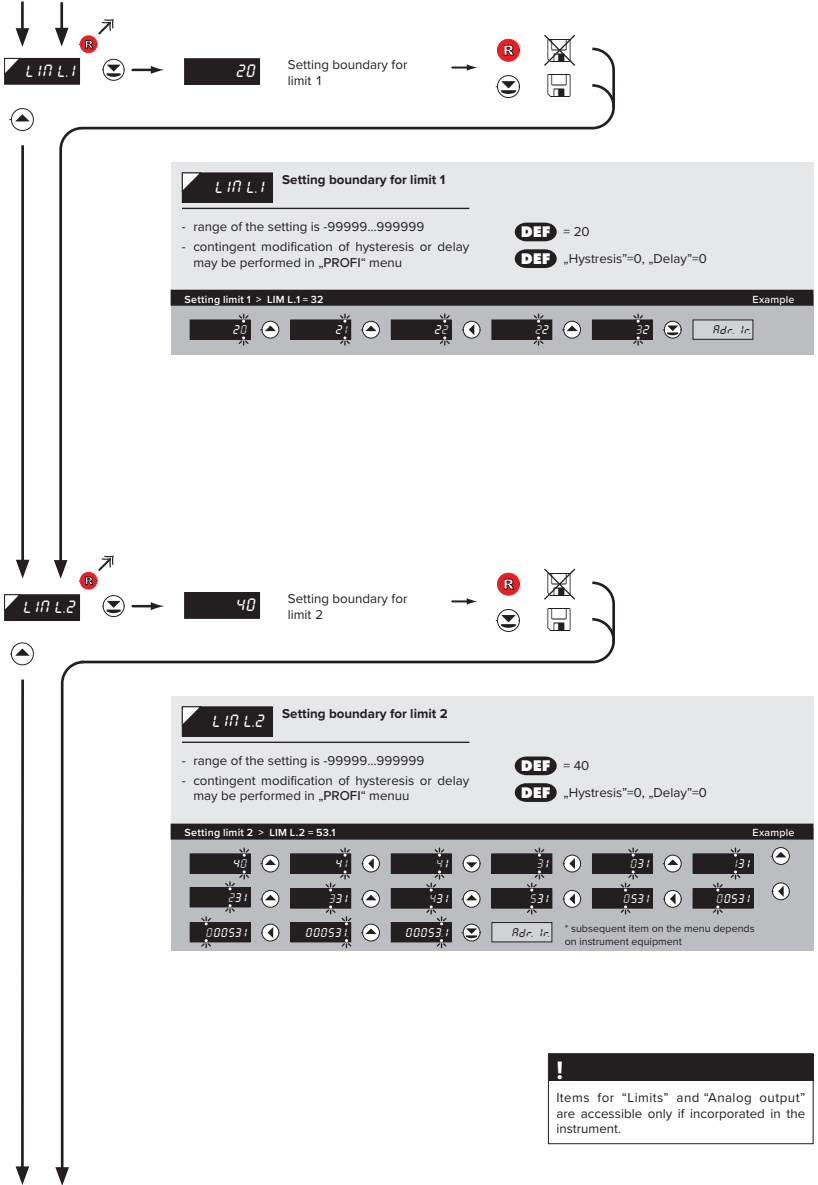

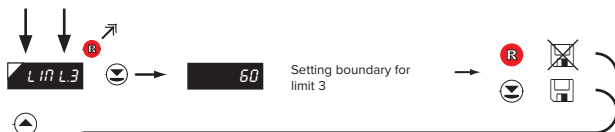

LIM L3 Setting boundary for limit 3

- range of the setting is -99999...999999
- contingent modification of hysteresis or delay may be performed in „PROFI“ menu

DEF = 60
DEF „Hysteresis“=0, „Delay“=0

Setting limit3 > LIM L.3 = 85 Example

60	61	62	63	64	65
65	75	85	Adr. Ir.	* subsequent item on the menu depends on instrument equipment	



LIM L4 Setting boundary for limit 4

- range of the setting is -99999...999999
- contingent modification of hysteresis or delay may be performed in „PROFI“ menu

DEF = 80
DEF „Hysteresis“=0, „Delay“=0

Setting limit4 > LIM L.4 = 103 Example

80	81	82	83	84	85
83	003	103	Adr. Ir.	* subsequent item on the menu depends on instrument equipment	

DISPLAYED ONLY WITH OPTIONS > COMPARATORS

5. SETTING LIGHT

DISPLAYED ONLY WITH OPTIONS > ANALOG OUTPUT

TYP. A.O. Setting the type of analog output

Menu	Range	Description
0-20mA	0...20 mA	
Er4-T	4...20 mA	signaling interrupted current loop and displaying an error message (<3,6 mA)
4-20T	4...20 mA	signaling broken current loop (<3,6 mA)
Er4-20mA	4...20 mA	with indication of error statement (<3,6 mA)
4-20mA	4...20 mA	
0.5mA	0...5 mA	
0-2 V	0...2 V	
0-5 V	0...5 V	
0-10 V	0...10 V	
+10 V	±10 V	

DEF = 4...20 mA

Typ analogového výstupu - 0...10 V > TYP A.V. = U 10

Example: 4-20mA, 0-5mA, 0-2V, 0-5V, 0-10V, AN. A.O.

AN. A.O. Assigning the display value to the beginning of the AO range

- range of the setting is -99999...999999

DEF = 0

Display value for the beginning of the AO range > MIN A.O. = 0

Example: 0, AN. A.O.

!

Items for "Limits" and "Analog output" are accessible only if incorporated in the instrument.

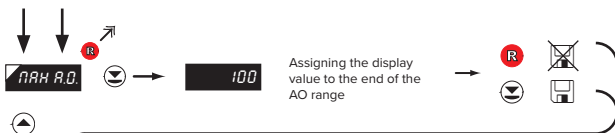

RRH R.O. Assigning the display value to the end of the AO range

- range of the setting is -99999...999999 **DEF** = 100

Display value for the end of the AO range > MAX A.O. = 120 Example

100 100 120 120 Rdr, Ir

DISPLAYED ONLY WITH OPTIONS > ANALOG OUTPUT

5. SETTING LIGHT

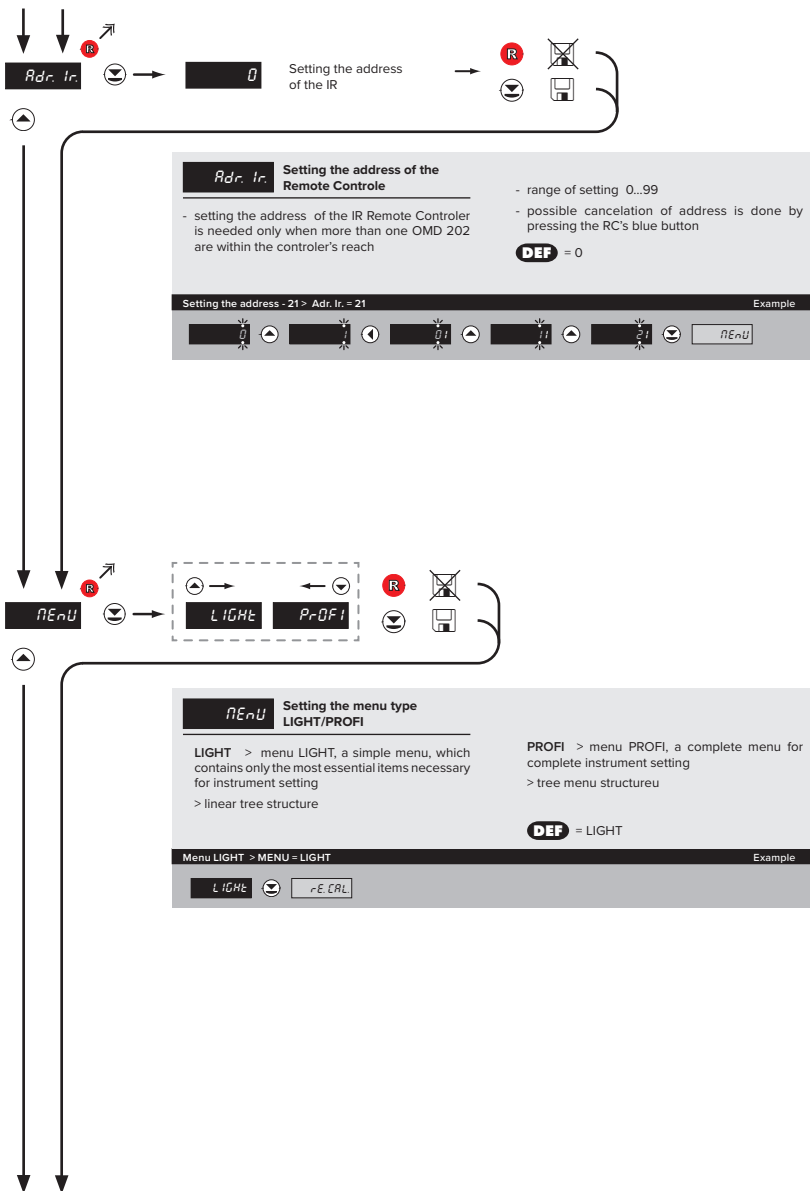

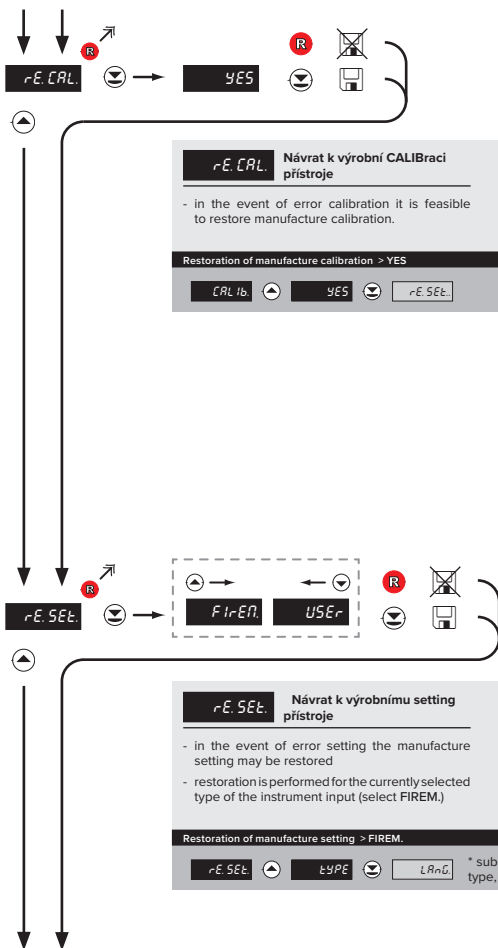

Type „DC“		53
Type "PM"		53
Type "OHM"		53
Type "RTD-Pt"		53
Type "RTD-Ni"		53
Type "T/C"		53
Type "DU"		52
Type "RTD-Cu"		53

5. SETTING LIGHT

DU

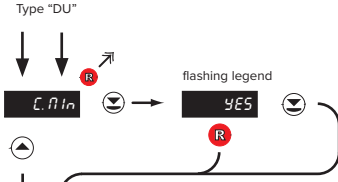

C.MIN	Calibration of input range - the potentiometer traveller in initial position	Only for type "DU"
- prior confirming the flashing "YES" sign the potentiometer traveller has to be in given idle position		
Calibration of the beginning of the range > C. MIN		Example
YES	C.MAX	

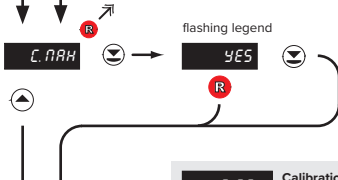

C.MAX	Calibration of input range - the potentiometer traveller in end position	Only for type "DU"
- prior confirming the flashing "YES" sign the potentiometer traveller has to be in given idle position		
Calibration of the end of the range > C. MAX		Example
YES	L.RNG	



LANG. Selection of language in instrument menu

- selection of language version of the instrument menu

DEF = ENGL.

Language selection - ENGLISH > LANG. = ENGL. Example

C2ECH ◀ ▶ EnGL ⏴ ⏵ PAS. L1

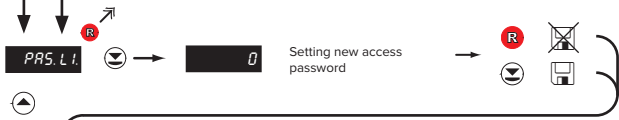

PAS. L1. Setting new access password

- access password for menu LIGHT
- range of the number code 0..9999
- upon setting the password to "000" the access to menu LIGHT is free without prompt to enter it

- in the event of loss universal password "8177" may be used!

DEF = 0

New password - 341 > PAS. L1. = 341 Example

0	1	2	3	4	5	6	7	8	9
◀	▶	◀	▶	◀	▶	◀	▶	◀	▶
4	0	4	1	4	1	4	1	4	1
▶	◀	▶	◀	▶	◀	▶	◀	▶	◀

IdEnt.

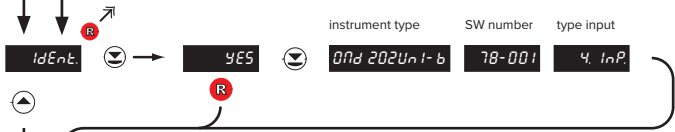

IdEnt. Instrument SW version

- the display shows the type of instrument indication, SW number, SW version and current input setting (Mode)
- if SW version contains a letter in first position, then it is a customer SW

- after the identification is completed the menu is automatically exited and the instrument restores the measuring mode

142.8 Return to measuring mode

6. SETTING PROFI



Programming scher

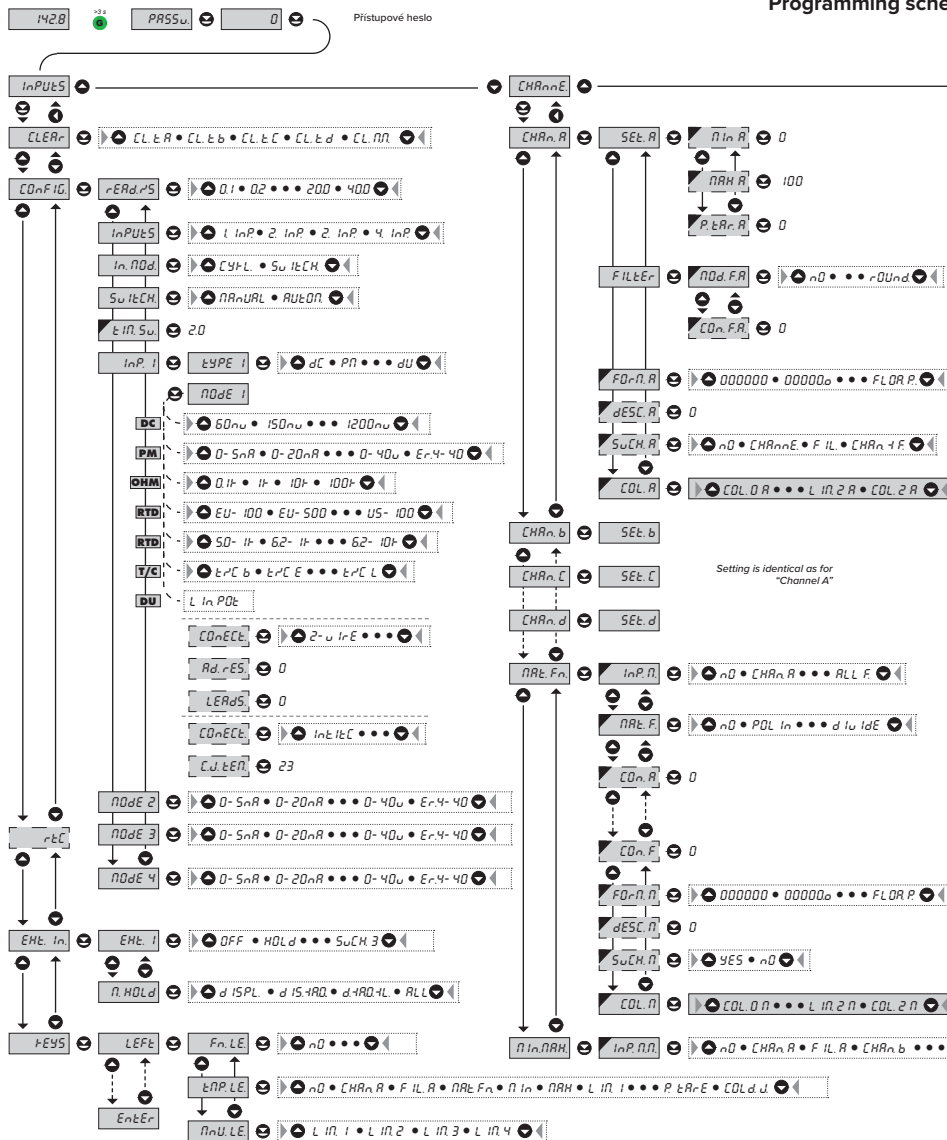

me of PROFI MENU

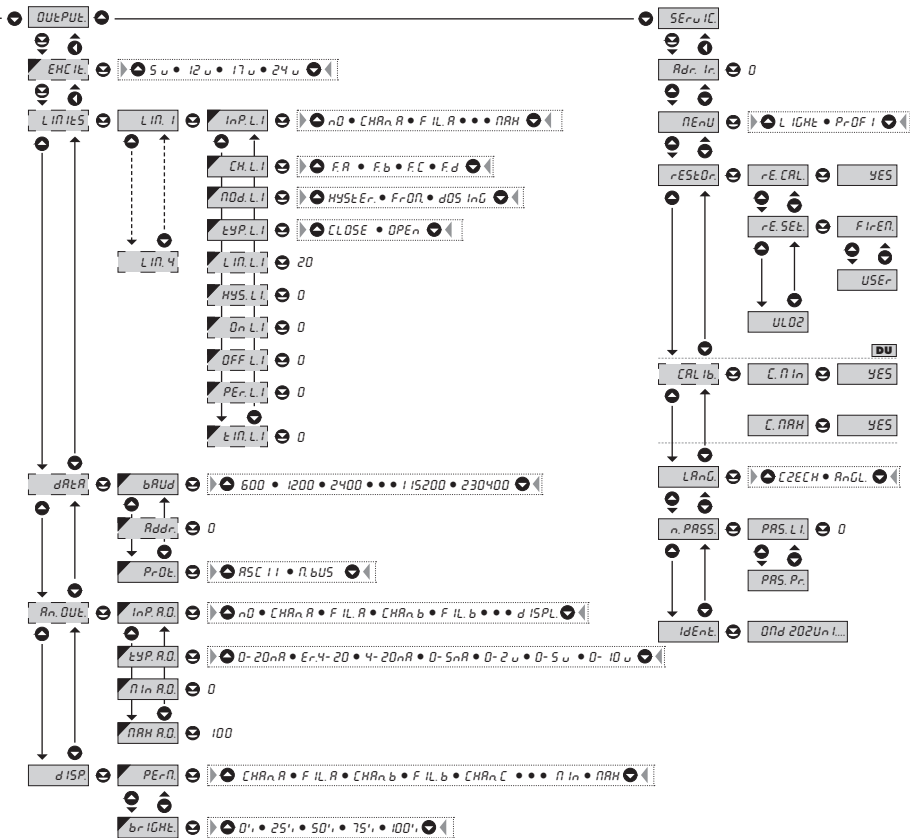

!
Upon delay exceeding 60 s the programming mode is automatically discontinued and the instrument itself restores the measuring mode

SETTING **PROFI**

For expert users

Complete instrument menu

Access is password protected

Possibility to arrange items of the **USER MENU**

Tree menu structure

6.0 SETTING "PROFI"

PROFI

Complete programming menu

- contains complete instrument menu and is protected by optional number code
- designed for expert users
- preset from manufacture is menu **LIGHT**

Switching over to "PROFI" menu

>3 s



- access to **PROFI** menu
- authorization for access to **PROFI** menu does not depend on setting under item **SERVIC. > MENU**
- password protected access (unless set as follows under the item **SERVIC. > N. PASS. > PROFI =0**)



- access to menu selected under item **SERVIC. > MENU > LIGHT/PROFI**
- password protected access (unless set as follows under the item **SERVIC. > N. PASS. > LIGHT =0**)
- for access to **LIGHT** menu passwords for **LIGHT** and **PROFI** menu may be used



6. SETTING PROFI

6.1 SETTING "PROFI" - INPUT

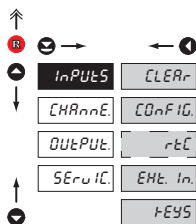

The primary instrument parameters are set in this menu

CLEAR	Resetting internal values
CONFIG	Selection of measuring range and parameters
rtc	Setting date and time for option RTC
EHE. In	Setting external inputs functions
F.EYS	Assigning further functions to keys on the instrument

6.1.1 RESETTING INTERNAL VALUES

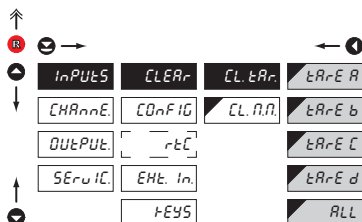

CLEAR	Resetting internal values
tArE A	Tare resetting - Channel A
tArE B	Tare resetting - Channel B
tArE C	Tare resetting - Channel C
tArE D	Tare resetting - Channel D
ALL	Tare resetting - Channel A, B, C and D
CL. n.n	Resetting min/max value

- resetting memory for the storage of minimum and maximum value achieved during measurement

6.1.2a SELECTION OF MEASURING RATE

↑

R →

← **◀**

INPUTS	CLEAR	rERd.rS	40.0
CHARnNE	CONFID	INPUTS	20.0
OUTPUT	rEC	In.NOD	10.0
SERuIC	EHL. In.	SubtCH	5.0
	FEYS	tIn.Su	2.0
		InP.1	1.0
		NOdE 2	0.5
		NOdE 3	0.2
		NOdE 4	0.1

DEF

↑

↓ **◃**

rERd.rS Selection of measuring rate

- measuring rate very significantly affects the number of active inputs "INPUTS" and evaluation mode "IN.MOD." (the factual measuring rates are listed in chapter Technical data)

40.0	40,0 measurements/s
20.0	20,0 measurements/s
10.0	10,0 measurements/s
5.0	5,0 measurements/s
2.0	2,0 measurements/s
1.0	1,0 measurements/s
0.5	0,5 measurements/s
0.2	0,2 measurements/s
0.1	0,1 measurements/s

6.1.2b SELECTION OF THE NUMBER OF ACTIVE INPUTS

↑

R →

← **◀**

INPUTS	CLEAR	rERd.rS	1. InP.
CHARnNE	CONFID	InPUTS	2. InP.
OUTPUT	rEC	In.NOD	3. InP.
SERuIC	EHL. In.	SubtCH	4. InP.
	FEYS	tIn.Su	
		InP.1	
		NOdE 2	
		NOdE 3	
		NOdE 4	

DEF

↑

↓ **◃**

InPUTS Selection of the number of active inputs

- measuring rate depends on the number of active inputs (the factual measuring rates are listed in chapter Technical data)

1. InP.	Active input 1
2. InP.	Active inputs 1 and 2
3. InP.	Active inputs 1, 2 and 3
4. InP.	Active inputs 1, 2, 3 a 4

6. SETTING PROFI

6.1.2c SELECTION OF MEASURING MODE FOR MULTICHANNEL INSTRUMENT

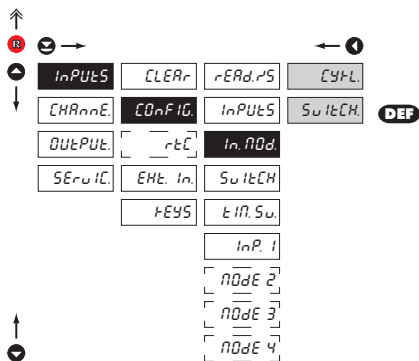

In. MOD. Selection of measuring mode in multichannel instrument

CYCL. Cyclic measuring on all channels

- instrument evaluates measured data simultaneously on all channels
- selection of cycle very significantly affects measuring rate and depends also on the number of active inputs (factual measuring rates are listed in the chapter Technical data)

SWITCH. Measuring on selected channel

- instrument evaluates measured data only on selected channel

6.1.2b SELECTION OF INPUTS SWITCHING

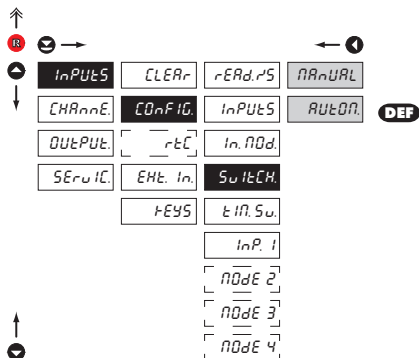

SWITCH. Selection of inputs switching

MANUAL Manual inputs switching

- inputs switching is controlled by selected key on the front panel or selected external input

AUTON. Automatic inputs switching

- inputs switching is automatic in a time period set in „TIM. SW.“

6.1.2e SETTING THE PERIOD FOR INPUTS SWITCHING

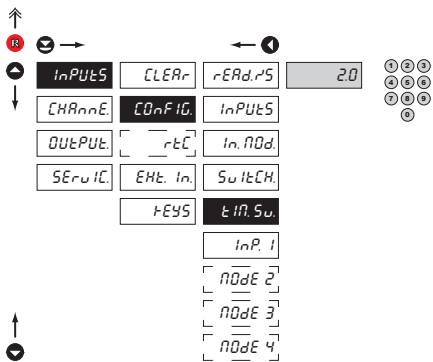
**tIn, Sw** Setting the period for inputs switching

- setting the time period for projection of channels in automatic mode ode of inputs switching „AUTOM.“
- range of the setting is 0,5...99,5 s (step 0,5 s)
- **DEF** TIM. SW. = 2,0 s

6.1.2f SELECTION OF „INSTRUMENT“ TYPE - CHANNEL 1

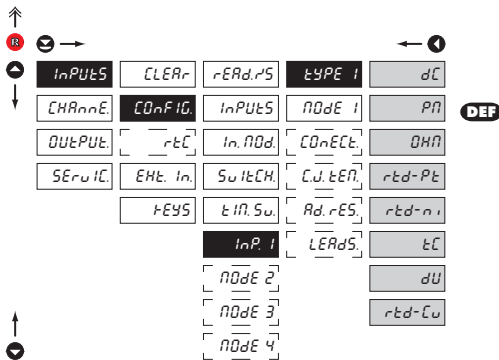
**tYPE** Selection of „instrument“ type - Channel 1

- selection of particular type of "instrument" is bound to relevant dynamic items

dC	DC voltmeter
Pn	Process monitor
OHM	Ohmmeter
rtd-Pt	Thermometer for Pt xxx
rtd-n,	Thermometer for Ni xxxx
tC	Thermometer for thermocouples
dU	Display for linear potentiometers
rtd-Cu	Thermometer for Cu xxx

6.1.2h SELECTION OF THE TYPE OF SENSOR CONNECTION - CHANNEL 1

RTD OHM T/C

↑

⊖ →

← ⊕

INPUTS	CLEAR	READ.PS	TYPE 1	2-w IrE	DEF
CHARACT.	CONF IG.	INPUTS	MODE 1	3-w IrE	
OUTPUTS	rEt	In. MOD.	CONF Ect.	4-w IrE	
SERVICES	EMT. In.	SUBTECH.	Ad. RES.		
	FYS	tim. Su.	LEADS.		
		InP. 1			
		MODE 2			
		MODE 3			
		MODE 4			

↓

↑

⊖ →

← ⊕

INPUTS	CLEAR	READ.PS	TYPE 1	InE. 1tE	DEF
CHARACT.	CONF IG.	INPUTS	MODE 1	InE. 2tE	
OUTPUTS	rEt	In. MOD.	CONF Ect.	EMT. 1tE	
SERVICES	EMT. In.	SUBTECH.	C.J. TEM.	EMT. 2tE	
	FYS	tim. Su.			
		InP. 1			
		MODE 2			
		MODE 3			
		MODE 4			

↓

CONF Ect. Selection of the type of sensor connection

RTDOHM

2-w IrE 2-wire connection

3-w IrE 3-wire connection

4-w IrE 4-wire connection

T/C

InE. 1tE Measurement without reference thermocouple

- measuring cold junction at instrument brackets

InE. 2tE Measurement with reference thermocouple

- measuring cold junction at instrument brackets with anti-series connected reference thermocouple

EMT. 1tE Measurement without reference thermocouple

- the entire measuring set is working under invaried and constant temperature

EMT. 2tE Measurement with reference thermocouple

- when using compensation box

!

Method and procedure of setting the cold junctions is described in separate chapter on page 98

!

For thermocouple type "B" the items CONECT. and C.J. TEM. are not available

6. SETTING PROFI

6.1.2i SETTING TEMPERATURE OF COLD JUNCTION - CHANNEL 1

T/C

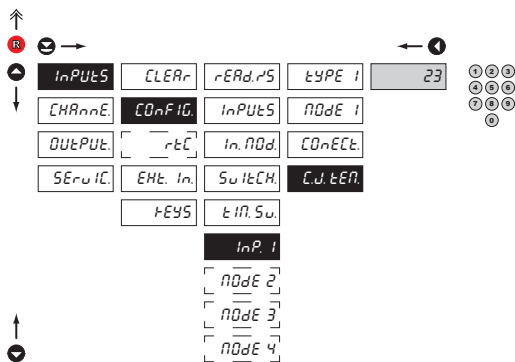

C.J.tEN. Setting temperature of cold junction

- range 0...99°C with compensation box

- **DEF** = 23°C

6.1.2j OFFSET OF THE BEGINNING OF THE MEASURING RANGE - CHANNEL 1

RTD OHM

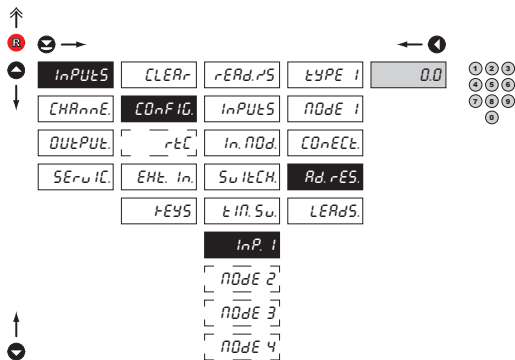

Ad.rES. Offset of the beginning of the measuring range

- in TIMEs when it is necessary to offset the beginning of the range by certain value, e.g. while using sensor in measuring head

- entered directly in Ohm (0...9999)

- **DEF** = 0

6.1.2k COMPENSATION OF 2-WIRE CONDUCT - CHANNEL 1

RTD OHM

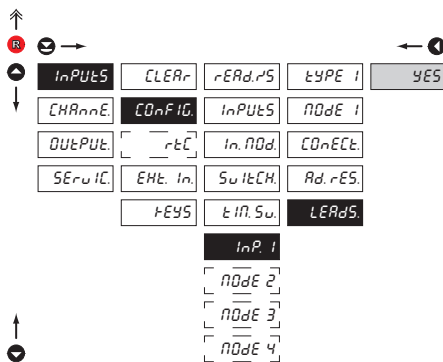

LERdS Compensation of 2-wire conduct

- for measurement accuracy it is necessary to perform compensation of conduct always in TIME of 2-wire connection
- prior confirmation of the displayed prompt „YES“ it is necessary to substitute the sensor at the end of the conduct by a short-circuit
- **DEF** = 0

6.1.2k SELECTION OF MEASURING RANGE - CHANNEL 2

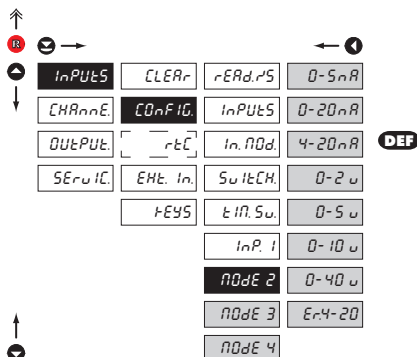

nDdE 2 Selection of measuring range - Channel 2

MODE 2	Menu	Měřicí rozsah
		0-5mA
	0-20mA	0...20 mA
	4-20mA	4...20 mA
	0-2 V	±2 V
	0-5 V	±5 V
	0-10 V	±10 V
	0-40 V	±40 V
	Er4-20	4...20 mA, with error statement of „underflow“ upon signal smaller than 3,36 mA

*

Setting procedure is identical for MODE 3 and MODE 4

6. SETTING PROFI

6.1.3 SETTING THE REAL TIME CLOCK

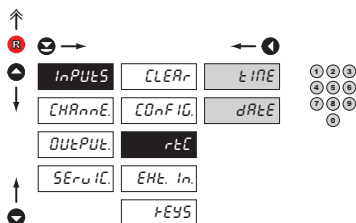

rEtC Setting the real time clock (RTC)

tIME Time setting
- format 23.59.59

dATE Date setting
- format DD.MM.RR

6.1.4a EXTERNAL INPUT FUNCTION SELECTION

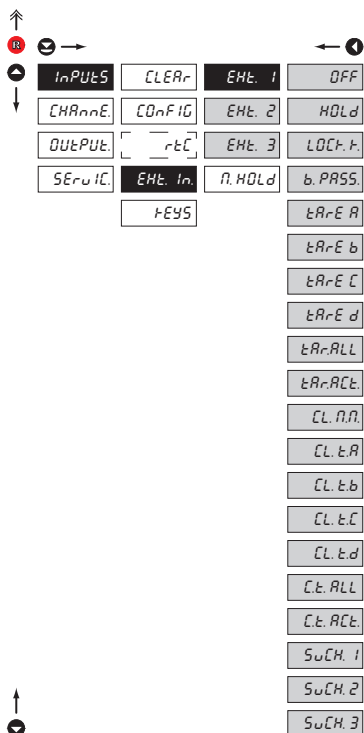

EHE In External input function selection

OFF Input is off

HOLD Activation of HOLD

LOCK Locking keys on the instrument

b.PASS Activation of locking access into programming menu

LIGHT/PROFI

tArE - Tare activation
- Tare A, B, C, D, All, Active (ACT)

CL.n.n Resetting min/max value

CL.t.- Tare resetting
- Tare A, B, C, D, All, Active (ACT)

SuCH 1 Successive switching of channel projection

SuCH 2 BCD switching of channel projection - EXT. 1 and 2
- for operation see the table
- following this choice the setting for EXT. 2 is automatically restricted

SuCH 3 BCD switching of channel projection - EXT. 1, 2 and 3
- for operation see the table
- following this choice the setting for EXT. 2 and EXT. 3 is automatically restricted

Table with operation of external inputs

Channel	Ext 1	Ext 2	Ext 3
FIL. A	0	0	
FIL. B	0	1	
FIL. C	1	0	
FIL. D	1	1	
MF	0	0	1
Min	0	1	1
Max	1	0	1
Max	1	1	1

- **DEF** EXT. 1 > HOLD
- **DEF** EXT. 2 > LOCK K.
- **DEF** EXT. 3 > SWCH.1

*

Setting procedure is identical for EXT. 2 and EXT. 3

6.1.4b SELECTION OF FUNCTION "HOLD"

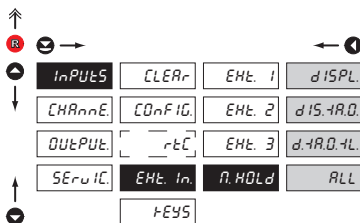

n. HOld Selection of function "HOLD"

dISPL. "HOLD" locks only the value displayed

dIS. ARD. "HOLD" locks the value displayed and on Analogue output

d. ARD. TL. "HOLD" locks the value displayed, on Analogue output and limit evaluation

ALL "HOLD" locks the entire instrument

6. SETTING PROFI

6.1.5a OPTIONAL ACCESSORY FUNCTIONS OF THE KEYS

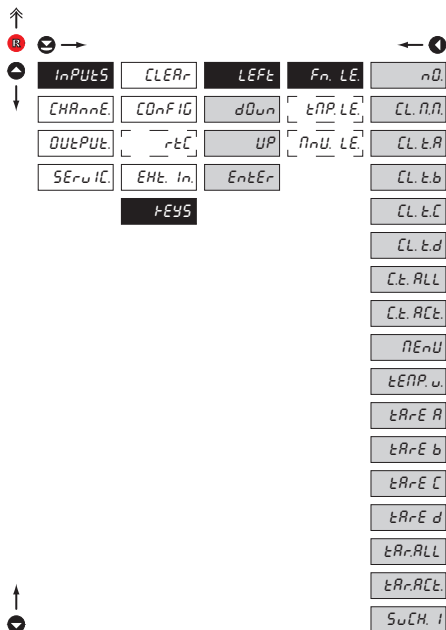

FN. LE Assigning further functions to instrument keys

- „FN. LE.“ > executive functions

nD Key has no further function

CL.n.n Resetting min/max value

CL.t.- Tare resetting

- Tare A, B, C, D, All, Active (ACT)

nEnU Direct access into menu on selected item

- after confirmation of this selection the “MENU. LE.” item is displayed on superior menu level, where required selection is performed

tENP. u Temporary projection of selected values

- after confirmation of this selection the item “TMP. LE.” is displayed on superior menu level, where required selection is performed

tArE Tare function activation

- Tare A, B, C, D, All, Active (ACT)

SuCH. 1 Successive switching of channel projection



Setting is identical for LEFT, DOWN, UP and ENTER



Actual channel is the one, that is projected on the display long term

6.1.5b OPTIONAL ACCESSORY FUNCTIONS OF THE KEYS - TEMPORARY PROJECTION

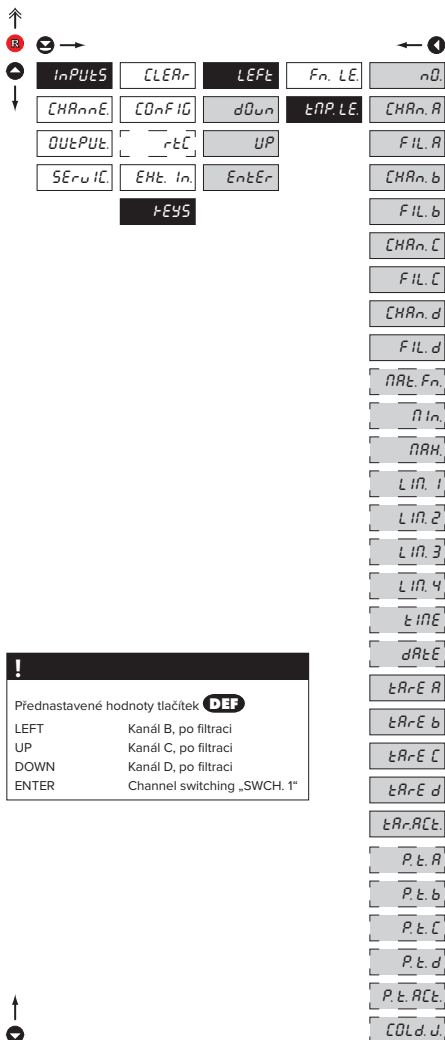
**tAR. LE** Temporary projection of selected item

- "Temporary" projection of selected value is displayed for the time of keystroke
- "Temporary" projection may be switched to permanent by pressing **RE** + "Selected key", this holds until the stroke of any key

nD	Temporary projection is off
CHANNEL. -	Temporary projection of "Channels A, B, C or D"
FIL. -	Temporary projection of "Channels A, B, C or D" after processing digital filters
NAR. Fn.	Temporary projection of "Mathematic functions" value
NIn.	Temporary projection of "Min. value"
NARH.	Temporary projection of "Max. value"
LIn. 1	Temporary projection of "Limita 1" value
LIn. 2	Temporary projection of "Limita 2" value
LIn. 3	Temporary projection of "Limita 3" value
LIn. 4	Temporary projection of "Limita 4" value
tInE	Temporary projection of "TIME" value
dARtE	Temporary projection of "DATE" value
tArE -	Temporary projection of "TARE" value
P. t. -	Dočasné zobrazení hodnoty "P. TARA" value
COLD. J.	Temporary projection of "CJC" value

!
Setting is identical for LEFT, DOWN, UP and ENTER

6. SETTING PROFI

6.1.5c

OPTIONAL ACCESSORY FUNCTIONS OF THE KEYS - DIRECT ACCESS TO ITEM

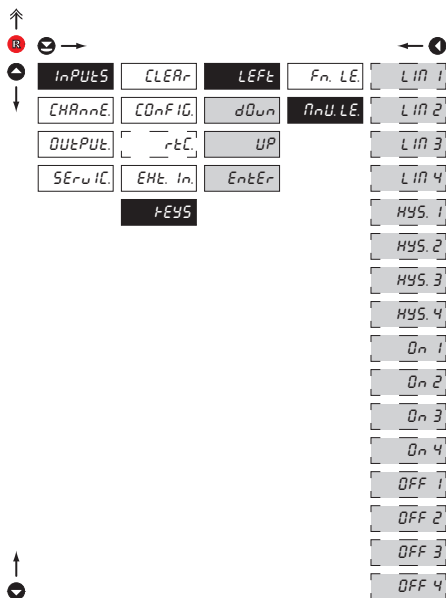

MNU, LE Assigning access to selected menu item

- „MNU, LE.“ > direct access into menu on selected item

LIN 1 Direct access to item "LIM. L.1"

LIN 2 Direct access to item "LIM. L.2"

LIN 3 Direct access to item "LIM. L.3"

LIN 4 Direct access to item "LIM. L.4"

HYS, 1 Direct access to item "HYS. L.1"

HYS, 2 Direct access to item "HYS. L.2"

HYS, 3 Direct access to item "HYS. L.3"

HYS, 4 Direct access to item "HYS. L.4"

ON 1 Direct access to item "ON L.1"

ON 2 Direct access to item "ON L.2"

ON 3 Direct access to item "ON L.3"

ON 4 Direct access to item "ON L.4"

OFF 1 Direct access to item "OFF L.1"

OFF 2 Direct access to item "OFF L.2"

OFF 3 Direct access to item "OFF L.3"

OFF 4 Direct access to item "OFF L.4"



Setting is identical for LEFT, DOWN, UP and ENTER



SETTING **PROFI** 6.

6. SETTING PROFI

6.2 SETTING "PROFI" - CHANNELS

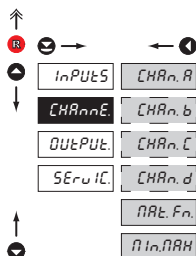

The primary instrument parameters are set in this menu

CHAN.A	Setting parameters of measuring "Channel A"
CHAN.B	Setting parameters of measuring "Channel B"
CHAN.C	Setting parameters of measuring "Channel C"
CHAN.D	Setting parameters of measuring "Channel D"
RANGE.Fn	Nastavení parametrů matematických funkcí
MIN/MAX	Volba vstupu pro vyhodnocení Min/max hodnoty

6.2.1a DISPLAY PROJECTION

DC PM DU OHM

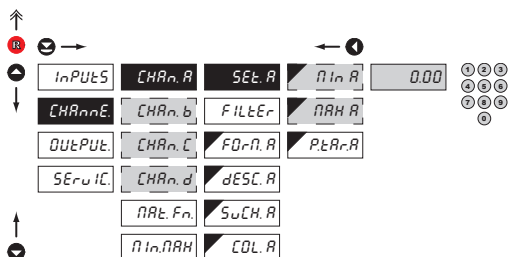

SET.A Setting display projection

MIN.A Setting display projection for minimum value of input signal

- range of the setting is -99999...999999
- **DEF** = 0

MAX.A Setting display projection for maximum value of input signal

- range of the setting is -99999...999999
- **DEF** = 100.00

6.2.1b SETTING FIXED TARE

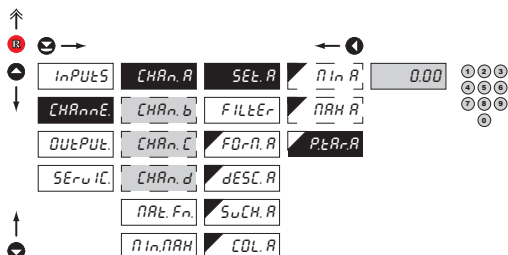

P.TAR.A Setting "Fixed tare" value

- setting is designed for the event when it is necessary to firmly shift the beginning of the range by known size
- when setting (P. TAR. A ≠ 0) is in effect, display does not show the "T" symbol
- range of the setting is: -99999...999999
- **DEF** = 0.00

6.2.1c DIGITAL FILTERS

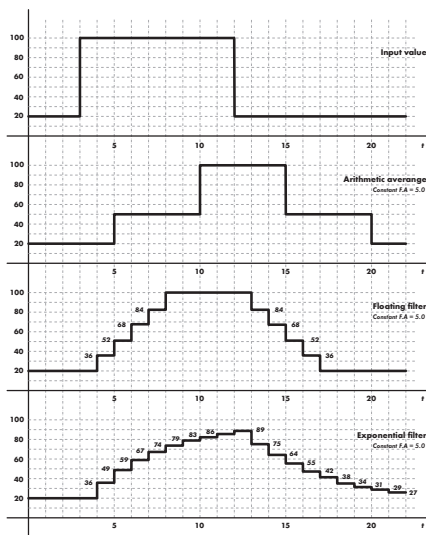
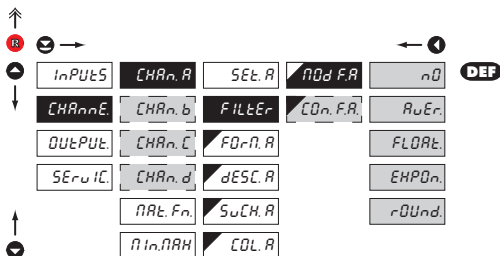

NOd.F.A Selection of digital filters

- at times it is useful for better user projection of data on display to modify it mathematically and properly, wherefore the following filters may be used:

nD Filters are off

RuEr Measured data average

- arithmetic average from given number („CON.F.A.“) of measured values
- range 2..100

FLORt Selection of floating filter

- floating arithmetic average from given number („CON.F.A.“) of measured data and updates with each measured value
- range 2..30

EHPOn Selection of exponential filter

- integration filter of first prvnho grade with time constant („CON.F.A.“) measurement
- range 2..100

rOUnd Measured value rounding

- is entered by any number, which determines the projection step (e.g.: "CON.F.A."=2,5 > display 0, 2,5, 5,...)

EOn.F.A Setting constants

- this menu item is always displayed after selection of particular type of filter
- **DEF** = 2

!
Setting is identical for "Channel B, C and D"

6. SETTING PROFI

6.2.1d PROJECTION FORMAT - POSITIONING OF DECIMAL POINT

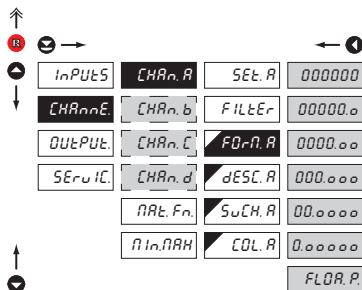

!
Setting is identical for "Channel B, C and D"

F0rA.A Selection of decimal point

- the instrument allows for classic projection of a number with positioning of the DP as well as projection with floating DP, allowing to display a number in its most exact form „FLOA. P“

000000	Setting DP - XXXXXX.
00000.0	Setting DP - XXXXX.x
DEF > RTD T/C	
0000.00	Setting DP - XXXX.xx
DEF > DC PM DU OHM	
000.000	Setting DP - XXX.xxx
00.0000	Setting DP - XX.xxxx
0.00000	Setting DP - X.xxxxx
FLOrA.P	Floating DP

6.2.1e PROJECTION OF DESCRIPTION - THE MEASURING UNITS

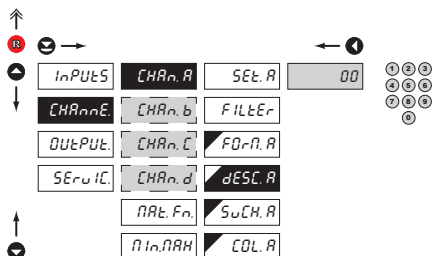

dESC.A Setting projection of descrpt. for "Channel A"

- projection of measured data may be extended (at the expense of the number of displayed places) by two characters for description
- description is set by shifted ASCII code, when two first places show the set description and two last characters their code in period 0...95
- description is cancelled by code 00

RTD T/C DEF = °C
DC PM DU OHM DEF =none

!
Table of signs on page 102

!
Setting is identical for "Channel B, C and D"

6.2.1f SELECTION OF CHANNEL PROJECTION UPON SWITCHING

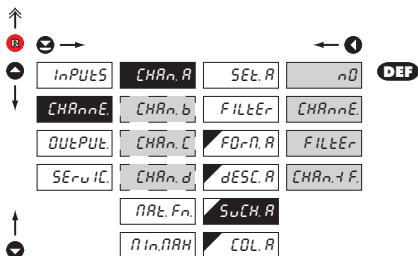
**SWCH.A** Selection of channel projection upon switching

- setting in this item enables the user to select individual measuring channels which will be displayed upon switching the channel functions „SWCH. A“

nD Projection restricted

CHAnnE "Channel A" will be displayed

FILtEr "Channel A" after modification by digital filter

CHAn.1F Will be displayed "Channel A" and subsequently also "Channel A" after modification by digital filter A

Setting is identical for "Channel B, C and D"

6.2.1g SELECTION OF DISPLAY COLOR

**COL.A** Selection of display color

- color selection is controlled through setting under items „LIM. 1 A“ and „LIM. 2 A“

rEd Red color

GrEEn Green color

OrAnGE Orange color

- „COL. 0 A“ **DEF** = Green

- „COL. 1 A“ **DEF** = Orange

- „COL. 2 A“ **DEF** = Red

Setting is identical for "Channel B, C and D"

6. SETTING PROFI

6.2.1h SELECTION OF DISPLAY COLOR CHANGE

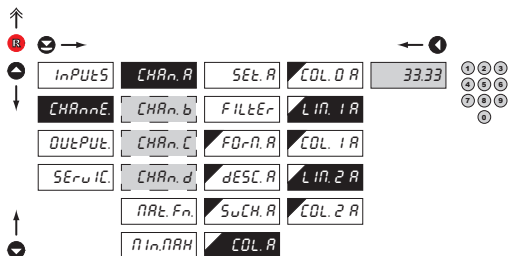

LIM. - A Selection of display color change

- under items "LIM.1 A" and "LIM.2 A" is set the limit when display color shall change

- „LIM. 1 A“ **DEF** = 33.33

- „LIM. 2 A“ **DEF** = 66.67



Setting is identical for "Channel B, C and D"

6.2.2a SELECTION OF INPUT FOR CALCULATION OF MATHEMATIC FUNCTION

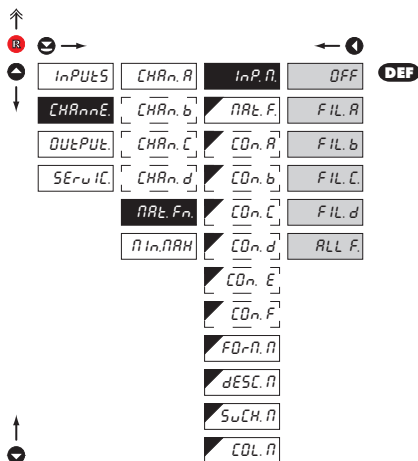

InP. A Selection of input for calculation of mathematic function

- selection of value from which the mathematic function will be calculated

OFF

Mathematic functions are off

FIL. A

From "Channel A" after modification by digital filter

FIL. B

From "Channel B" after modification by digital filter

FIL. C

From "Channel C" after modification by digital filter

FIL. D

From "Channel D" after modification by digital filter

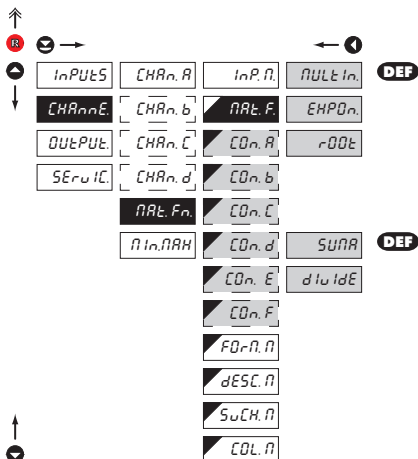
**PAR.F.**

Selection of mathematic functions

On selecting „FIL.-“ in item „INP.M.“

NULL In

Polynome

$$Ax^3 \square Bx^2 \square Cx^3 \square Dx^2 \square Ex \square F$$

EXPON

Exponential

$$A \square e^{\frac{Bx-C}{Dx+E}} \square F$$

rDDE

Root

$$A \square \sqrt{\frac{Bx-C}{Dx+E}} \square F$$

On selecting „ALL F.“ in item „INP.M.“

SUM

Sum of the values from channels (inputs)

$$(A \times KA + C \times KC) / (B \times KB + D \times KD) \times E + F$$

dIuIdE

Quotient of values from channels (inputs)

$$(A \times KA + C \times KC) / (B \times KB + D \times KD) \times E + F$$

CON.-

Setting constants for calculation of matfunctions

- this menu is displayed only after selection of given mathematic function

6. SETTING PROFI

6.2.2c MATHEMATIC FUNCTIONS - DECIMAL POINT

Navigation icons: ↑, ↓, ←, →, and a red circle with 'R'.

INPUTS	CHAR.a	InP.n	000000
CHAR.nE	CHAR.b	PAR.F	00000.0
OUTPUT	CHAR.c	CON.R	0000.00
SERuIC	CHAR.d	CON.b	000.000
	PAR.F.n	CON.c	00.0000
	In.PARH	CON.d	0.00000
		CON.E	FLOA.P DEF
		CON.F	
		FOr.n.n	
		dESC.n	
		PrEP.n	
		COL.n	

FOr.n.n. Selection of decimal point

- the instrument allows for classic projection of a number with positioning of the DP as well as projection with floating DP, allowing to display a number in its most exact form „FLOA. P“

000000	Setting DP - XXXXXX.
00000.0	Setting DP - XXXXX.x
0000.00	Setting DP - XXXX.xx
000.000	Setting DP - XXX.xxx
00.0000	Setting DP - XX.xxxx
0.00000	Setting DP - X.xxxxx
FLOA.P	Floating DP

- DEF

6.2.2d MATHEMATIC FUNCTIONS - MEASURING UNITS

Navigation icons: ↑, ↓, ←, →, and a red circle with 'R'.

INPUTS	CHAR.a	InP.n	00	①②③④⑤⑥⑦⑧⑨
CHAR.nE	CHAR.b	PAR.F		⑥
OUTPUT	CHAR.c	CON.R		
SERuIC	CHAR.d	CON.b		
	PAR.F.n	CON.c		
	In.PARH	CON.d		
		CON.E		
		CON.F		
		FOr.n.n		
		dESC.n		
		SuCH.n		
		COL.n		

dESC.n. Setting projection of description for "MAT.FN"

- projection of measured data may be extended (at the expense of the number of displayed places) by two characters for description
- description is set by shifted ASCII code, when two first places show the set description and two last characters their code in period 0...95
- description is cancelled by code 00

- DEF = no description

! Table of signs on page 102

6.2.2e MATHEMATIC FUNCTIONS - SELECTION OF CHANNEL PROJECTION UPON SWITCHING

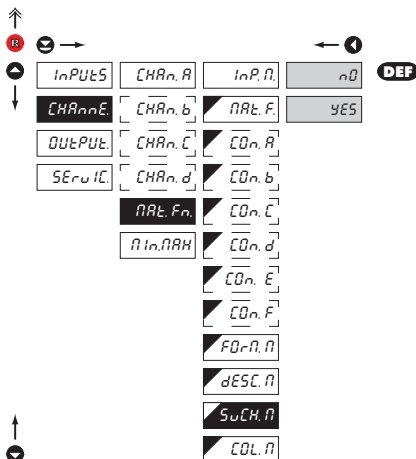
**SWCH.N** Selection of channel projection upon switching

- setting in this item enables the user to select individual measuring channels which will be displayed upon switching the channel functions „SWCH.M“

n0 Projection restricted

YES Projection permitted

6.2.2f MATHEMATIC FUNCTIONS - SELECTION OF DISPLAY COLOR

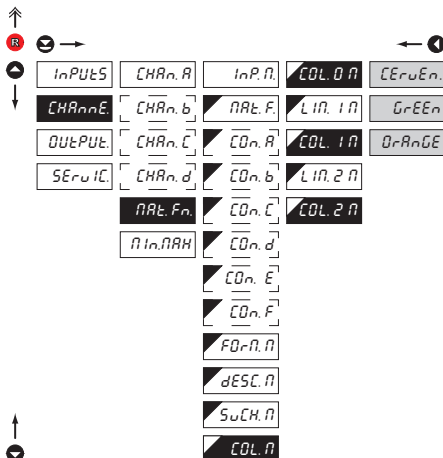
**COL.N** Selection of display color

- color selection is controlled through setting under items „LIM.1 M“ and „LIM.2 M“

rEd Red color

GrEEEn Green color

OrAnGE Orange color

- „COL.0 M“ **DEF** = Green

- „COL.1 M“ **DEF** = Orange

- „COL.2 M“ **DEF** = Red

6. SETTING PROFI

6.2.2g

MATHEMATIC FUNCTIONS - SELECTION OF DISPLAY COLOR CHANGE

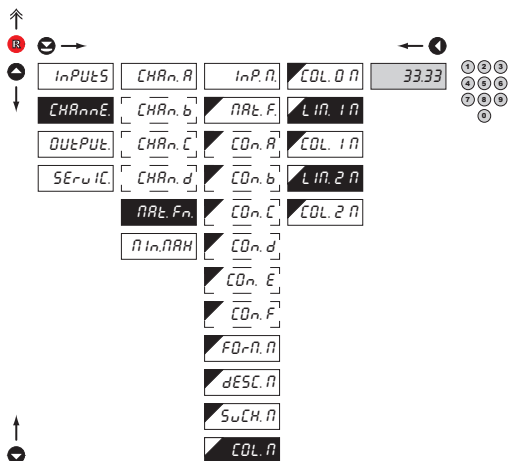

LIM. - n Selection of display color change

- under items „LIM. 1 M*“ and „LIM. 2 M*“ is set the limit when display color shall change

- „LIM. 1 M*“ **DEF** = 33.33

- „LIM. 2 M*“ **DEF** = 66.67



6.2.3 SELECTION OF EVALUATION OF MIN/MAX VALUE

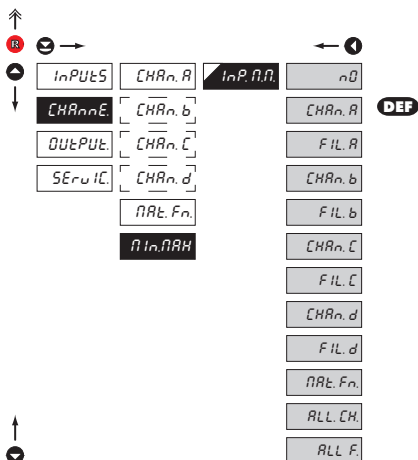

InP. n.n.	Selection of evaluation of min/max value
-	- selection of value from which the min/max value will be calculated
nD	Evaluation of min/max value is off
CHAn.a	From "Channel A"
FIL.R	From "Channel A" after digital filters processing
CHAn.b	From "Channel B"
FIL.b	From "Channel B" after digital filters processing
CHAn.c	From "Channel C"
FIL.c	From "Channel C" after digital filters processing
CHAn.d	From "Channel D"
FIL.d	From "Channel D" after digital filters processing
nARt.Fn	From "Mathematic functions"
ALL.CH.	From "Channel A, B, C and D"
ALL.F.	From "Channel A, B, C and D" after digital filters processing

6. SETTING PROFI

6.3 SETTING „PROFI“ - OUTPUTS

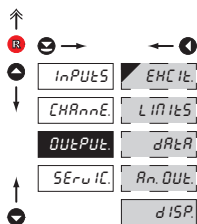

In this menu it is possible to set parameters of the instrument output signals

- EHC It.** Volba výstupního napětí pomocného zdroje
- LIMITS** Setting type and parameters of limits
- dAR** Setting type and parameters of data output
- An. OUT.** Setting type and parameters of analog output
- dISP.** Setting display projection and brightness

6.3.1 SELECTION OF SENSOR EXCITATION VOLTAGE

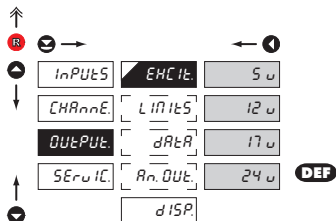

EHC It. Selection of sensor excitation voltage (aux. power supply)

- 5 u** 5 VDC, max. 2.5 W
- 12 u** 12 VDC, max. 2.5 W
- 17 u** 17 VDC, max. 2.5 W
- 24 u** 24 VDC, max. 2.5 W

6.3.2a SELECTION OF INPUT FOR LIMITS EVALUATION

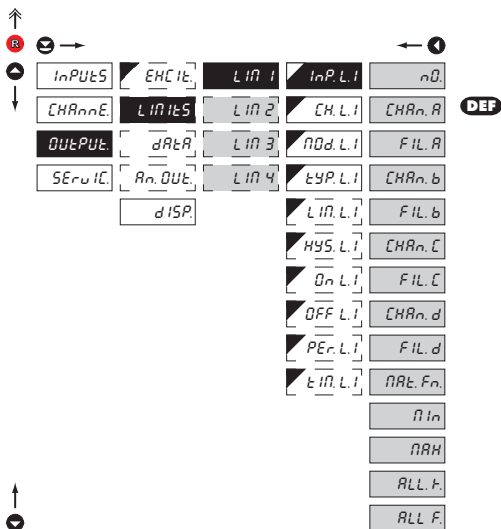
**InP.L.1** Selection evaluation of limits

- selection of value from which the limit will be evaluated

- nD Limit evaluation is off
- CHANn.A Limit evaluation from "Channel A"
- FIL.A Limit evaluation from "Channel A" after digital filters processing
- CHANn.b Limit evaluation from "Channel B"
- FIL.b Limit evaluation from "Channel B" after digital filters processing
- CHANn.C Limit evaluation from "Channel C"
- FIL.C Limit evaluation from "Channel C" after digital filters processing
- CHANn.d Limit evaluation from "Channel D"
- FIL.d Limit evaluation from "Channel D" after digital filters processing
- MAE.Fn Limit evaluation from "Mathematic functions"
- nIn Limit evaluation from "Min.value"
- MAH Limit evaluation from "Max.value"
- ALL.F From "Channel A, B, C and D"
- ALL.F From "Channel A, B, C and D" after digital filters processing

!
Setting is identical for LIM 2, LIM 3 and LIM 4

6. SETTING PROFI

MODE > HYSTER • FROM - TO • DOSING

DESCRIPTION OF RELAY FUNCTION

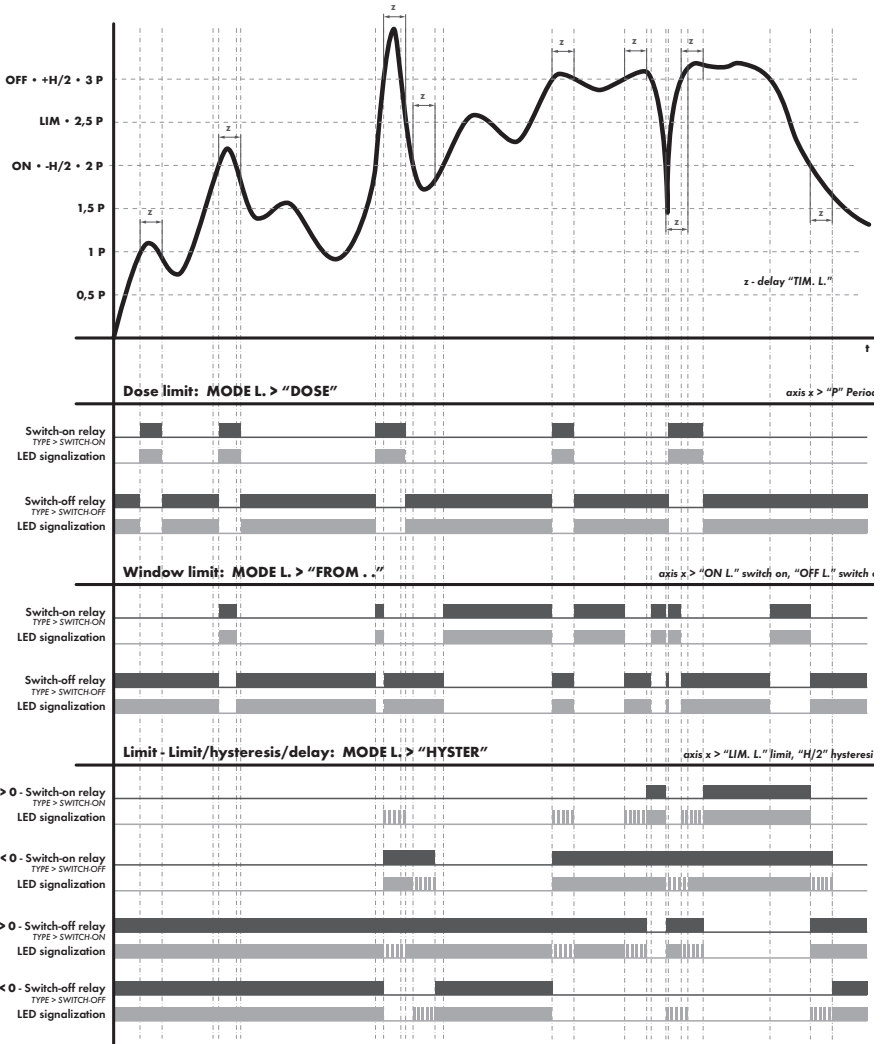

6.3.2b SELECTION OF MORE CHANNELS FOR LIMIT EVALUATION

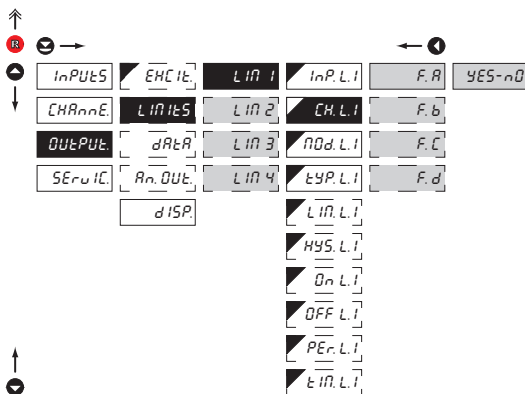
**CH.L.I** Selection of channels for limit evaluation

- the item is accessible only if items "ALL.CH" or "ALL.F." are set in *OUTPUT/LIMITS/LIM 1/INP.L.I*, when "ALL.CH." is selected descriptions "CH.A...D" are displayed, when "ALL.F." descriptions "FA...D"
- setting allows to assign arbitrary number of measuring channels to one limit for their evaluation
- the limit is active if at least one value in arbitrary channel exceeds set limit

- **DEF** = YES

Setting is identical for LIM 2, LIM 3 and LIM 4

6.3.2c VOLBA TYPU LIMIT

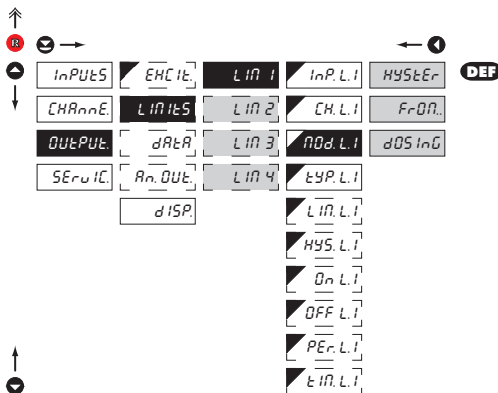
**nDd.L.I** Selection of the type of limit

HYS.tEr Limit is in mode "Limit, hysteresis, delay"

- for this mode the parameters of "LIM.L." are set, at which the limit will shall react, "HYS.L." the hysteresis range around the limit (LIM $\pm 1/2$ HYS) and time "TIM.L." determining the delay of relay switch-on

FrOn. Frame limit

- for this mode the parameters are set for interval "ON.L." the relay switch-on and "OFF.L." the relay switch-off

dOS inG Dose limit (periodic)

- for this mode the parameters are set for "PER.L." determining the limit value as well as its multiples at which the output is active and "TIM.L." indicating the time during which is the output active

Setting is identical for LIM 2, LIM 3 and LIM 4

6. SETTING PROFI

6.3.2d SELECTION OF TYPE OF OUTPUT

Navigation diagram for setting output type. The grid contains the following items:

- Inputs: InPULS, EHCIt, LIN 1, InP.L1, CLOSE
- CHARnE: CHARnE, LIMITS, LIN 2, CH.L1, rDZPin
- OUTPUL: dRtR, LIN 3, Ad.L1
- SERuIC: An.QUE, LIN 4, tYP.L1
- dISP: dISP, LIN.L1, HYS.L1, On.L1, OFF.L1, PER.L1, tIn.L1

Navigation arrows: Up (↑), Down (↓), Left (←), Right (→), Home (⊕), and a red 'R' button.

tYP.L1 Selection of type of output

- CLOSE** Output switches on when condition is met
- OPEN** Output switches off when condition is met

Setting is identical for LIM 2, LIM 3 and LIM 4

6.3.2e SETTING VALUES FOR LIMITS EVALUATION

Navigation diagram for setting limit values. The grid contains the following items:

- Inputs: InPULS, EHCIt, LIN 1, InP.L1, 0
- CHARnE: CHARnE, LIMITS, LIN 2, CH.L1
- OUTPUL: dRtR, LIN 3, Ad.L1
- SERuIC: An.QUE, LIN 4, tYP.L1
- dISP: dISP, LIN.L1, HYS.L1, On.L1, OFF.L1, PER.L1, tIn.L1

Navigation arrows: Up (↑), Down (↓), Left (←), Right (→), Home (⊕), and a red 'R' button. A numeric keypad (0-9) is shown to the right.

LIM.L1 Setting limit for switch-on

- for type "HYSTER."

HYS.L1 Setting hysteresis

- for type "HYSTER."
- indicates the range around the limit (in both directions, LIM. $\pm 1/2$ HYS.)

On.L1 Setting the outset of the interval of limit switch-on

- for type "FROM."

OFF.L1 Setting the end of the interval of limit switch-on

- for type "FROM."

PER.L1 Setting the period of limit switch-on

- for type "DOSING"

tIn.L1 Setting the time switch-on of the limit

- for type "HYSTER." and "DOSING"
- setting within the range: $\pm 99,9$ s
- positive time > relay switches on after crossing the limit (LIM. L1) and the set time (TIM. L1)
- negative time > relay switches off after crossing the limit (LIM. L1) and the set negative time (TIM. L1)

Setting is identical for LIM 2, LIM 3 and LIM 4



6.3.3a SELECTION OF DATA OUTPUT BAUD RATE

bAUd Selection of data output baud rate

600	Rate - 600 Baud
1200	Rate - 1 200 Baud
2400	Rate - 2 400 Baud
4800	Rate - 4 800 Baud
9600	Rate - 9 600 Baud
19200	Rate - 19 200 Baud
38400	Rate - 38 400 Baud
57600	Rate - 57 600 Baud
115200	Rate - 115 200 Baud
230400	Rate - 230 400 Baud

6.3.3b SETTING INSTRUMENT ADDRESS

Addr. Setting instrument address

- setting in range 0...31
- **DEF** = 00

Adr. P.b. Setting instrument address - PROFIBUS

- setting in range 1..127
- **DEF** = 19

6. SETTING PROFI

6.3.3c SELECTION OF DATA OUTPUT PROTOCOL

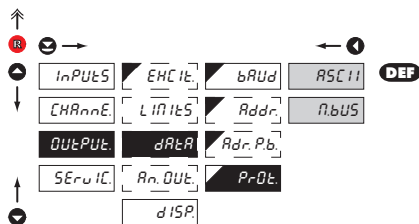

PrOt. Selection of the type of analog output

ASC11 Data protocol ASCII

n.bUS Data protocol DIN MessBus

6.3.4a SELECTION OF INPUT FOR ANALOG OUTPUT

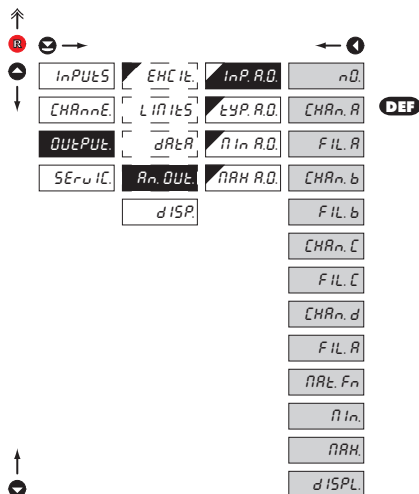

InP.A.D. Selection evaluation analog output

- selection of value from which the analog output will be evaluated

nD AO evaluation is off

CHAn.A AO evaluation from "Channel A"

FiL.A AO evaluation from "Channel A" after digital filters processing

CHAn.b AO evaluation from "Channel B"

FiL.b AO evaluation from "Channel B" after digital filters processing

CHAn.C AO evaluation from "Channel C"

FiL.C AO evaluation from "Channel C" after digital filters processing

CHAn.d AO evaluation from "Channel D"

FiL.d AO evaluation from "Channel D" after digital filters processing

nRH.F.n AO evaluation from "Math.functions"

nIn AO evaluation from "Min.value"

nRH AO evaluation from "Max.value"

dISPL. From "Permanently projected display value"

6.3.4b SELECTION OF THE TYPE OF ANALOG OUTPUT

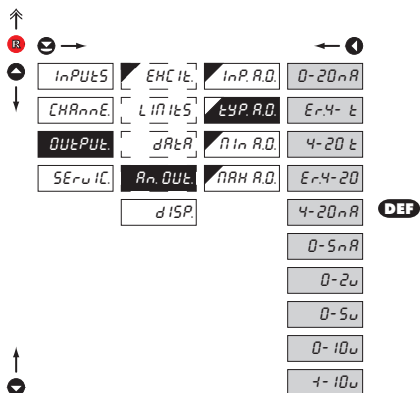
**tYP. R.O.** Selection of the type of analog output

- 0-20nA** Type: 0...20 mA
- Er.4-t** Type: 4...20 mA, with broken loop detection and indication of error status (< 3,0 mA)
- 4-20t** Type: 4...20 mA, with broken loop detection (< 3,0 mA)
- Er.4-20** Type: 4...20 mA, with indic. of error statement (< 3,0 mA)
- 4-20nA** Type: 4...20 mA
- 0-5nA** Type: 0...5 mA
- 0-2u** Type: 0...2 V
- 0-5u** Type: 0...5 V
- 0-10u** Type: 0...10 V
- +/-10u** Type: ±10 V

6.3.4c SETTING THE ANALOG OUTPUT RANGE

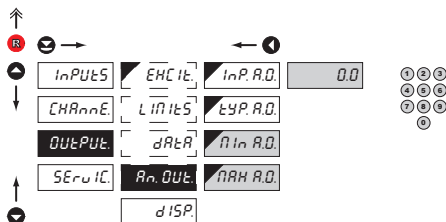
**Rn. OUt.** Setting the analog output range

- analog output is isolated and its value corresponds with displayed data. It is fully programmable, i.e. it allows to assign the AO limit points to two arbitrary points of the entire measuring range

nIn.R.O. Assigning the display value to the beginning of the AO range

- range of the setting is -99999...999999

- **DEF** = 0

nRn.R.O. Assigning the display value to the end of the AO range

- range of the setting is -99999...999999

- **DEF** = 100

6. SETTING PROFI

6.3.5a

SELECTION OF INPUT FOR DISPLAY PROJECTION

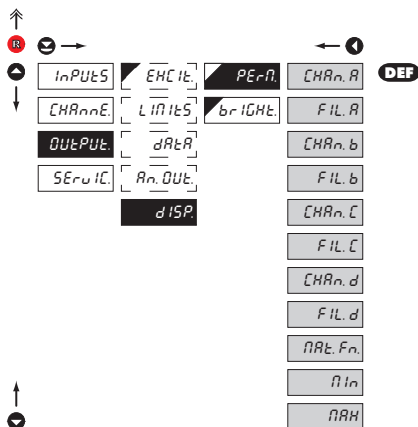

PERF. Selection display projection

- selection of value which will be shown on the instrument display

- CHAR.A** Projection of values from "Channel A"
- FIL.A** Projection of values from "Channel A" after digital filters processing
- CHAR.b** Projection of values from "Channel B"
- FIL.A** Projection of values from "Channel B" after digital filters processing
- CHAR.C** Projection of values from "Channel C"
- FIL.C** Projection of values from "Channel C" after digital filters processing
- CHAR.d** Projection of values from "Channel D"
- FIL.d** Projection of values from "Channel D" after digital filters processing
- MATH.Fn** Projection of values from "Math.functions"
- Min** Projection of values from "Min.value"
- MAX** Projection of values from "Max.value"

6.3.5b

SELECTION OF DISPLAY BRIGHTNESS

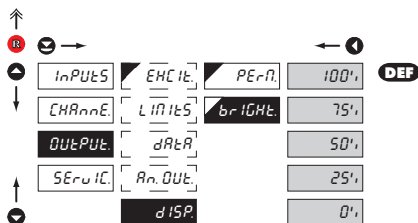

brIGHt Selection of display brightness

- by selecting display brightness we may appropriately react to light conditions in place of instrument location

- 0'** Display is off
- after keystroke display turns on for 10 s
- 25'** Display brightness - 25%
- 50'** Display brightness - 50%
- 75'** Display brightness - 75%
- 100'** Display brightness - 100%



6. SETTING PROFI

6.4 SETTING "PROFI" - SERVICE

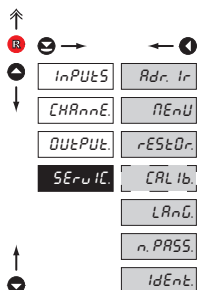

The instrument service functions are set in this menu

Adr. Ir.	Nastavení adresy IR ovládání
nEnU	Selection of menu type LIGHT/PROFI
rEStOr.	Restore instrument manufacture setting and calibration
CARL Ib	Input range calibration for „DU“ version
LAnG.	Language version of instrument menu
n.PASS.	Setting new access password
IdEnt.	Instrument identification

6.4.1 SETTING THE ADDRESS OF IR REMOTE CONTROL

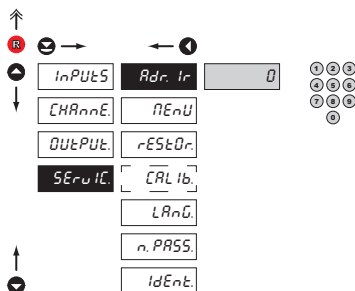

Adr. Ir. Setting the address of IR remote control

- setting the remote control address is inevitable only in case there are other large displays OMD 202 within the reach of IR remote control
- range of the setting is 0...99
- you can cancel the address by pressing the blue key on the remote control
- **DEF** = 0

6.4.2 RESTORATION OF MANUFACTURE SETTING

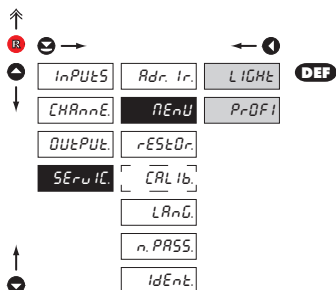
**nEnU** Selection of menu type - LIGHT/PROFI

- enables setting the menu complexity according to user needs and skills

LIghT Active LIGHT menu

- simple programming menu, contains only items necessary for configuration and instrument setting
- linear menu > items one after another

PrOFI Active PROFI menu

- complete programming menu for expert users
- tree menu



Change of setting is valid upon next access into menu

6.4.3 RESTORATION OF MANUFACTURE SETTING

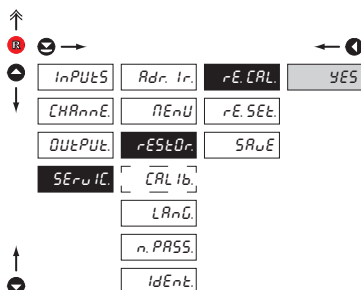
**rEStOr.** Restoration of manufacture setting

- in the event of error setting or calibration, manufacture setting may be restored

rE.CAL. Restoration of manufacture calibration of the instrument

- prior executing the changes you will be asked to confirm you selection „YES“

6. SETTING PROFI

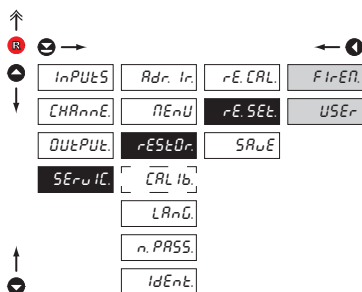

rE.SET. Restoration of instrument manufacture setting

FlrEr. Restoration of instrument manufacture setting

- generating the manufacture setting for currently selected type of instrument (items marked DEF)

USER Restoration of instrument user setting

- generating the instrument user setting, i.e. setting stored under SERVIC./RESTOR./SAVE

SAUE Save instrument user setting

- storing the user setting allows the operator to restore it in future if needed

!

After restoration the instrument switches off for couple seconds

JOBS PERFORMED

RESTORE

JOBS PERFORMED	RESTORE	
	CALIBRATION	SETTING
cancels USER menu rights	✓	✓
deletes table of items order in USER - LIGHT menu	✓	✓
adds items from manufacture to LIGHT menu	✓	✓
deletes data stored in FLASH	✓	✓
cancels or linearization tables	✓	✓
clears tare	✓	✓
restore manufacture calibration	✓	✗
restore manufacture setting	✗	✓

6.4.4

CALIBRATION - INPUT RANGE

DU

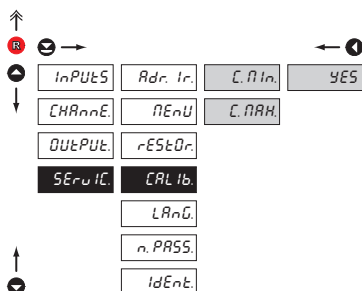

CAL Ib. Input range calibration

- when "C. MIN" is displayed, move the potentiometer traveller to the required minimum position and confirm by „Enter“, calibration is confirmed by „YES“

- when "C. MAX" is displayed, move the potentiometer traveller to required maximum position and confirm by „Enter“, calibration is confirmed by „YES“

6.4.5 SELECTION OF INSTRUMENT MENU LANGUAGE VERSION

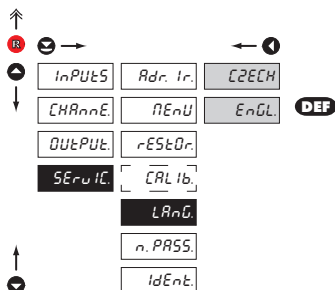
**LANG.** Selection of instrument menu language version

CZECH Instrument menu is in Czech

EnGL. Instrument menu is in English

6.4.6 SETTING NEW ACCESS PASSWORD

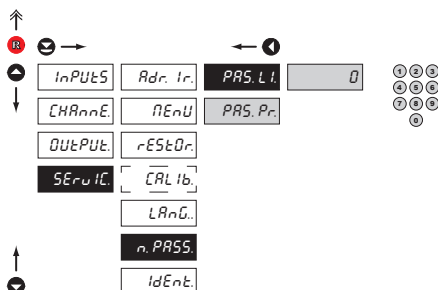
**n.PASS.** Setting new password for access to LIGHT and PROFI menu

- This option allows to change the numeric code, which blocks the access into LIGHT and PROFI Menu.
- numeric code range: 0...9999
- universal passwords in the event of loss: LIGHT Menu > „8177” PROFI Menu > „7915”

6.4.7 INSTRUMENT IDENTIFICATION

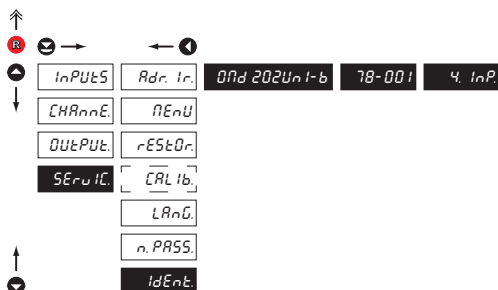
**IdEnt.** Projection of instrument SW version

- display shows type identification of the instrument, SW number, SW version and current input setting (Mode)
- if the SW version reads a letter on first position, it is a customer SW

IDENT.	Blok	Description
1.	Instrument	
2.	no. of SW version	
3.	type/input mode	

SETTING USER

For user operation

Menu items are set by the user (Profi/Light) as per request

Access is not password protected

Optional menu structure either tree (PROFI) or linear (LIGHT)

7.0 SETTING ITEMS INTO "USER" MENU

- **USER** menu is designed for users who need to change only several items of the setting without the option to change the primary instrument setting (e.g. repeated change of limit setting)
- there are no items from manufacture permitted in **USER** menu
- on items indicated by inverse triangle  L I
- setting may be performed in **LIGHT** or **PROFI** menu, with the **USER** menu then overtaking the given menu structure

Setting

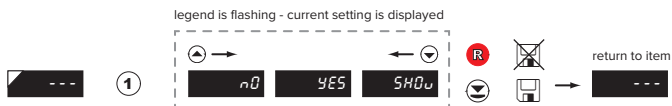

n0

item will not be displayed in USER menu

YES

item will be displayed in USER menu with the option of setting

SHOW

item will be solely displayed in USER menu

Setting items into „USER“ menu

When setting up the USER menu out of active LIGHT menu it is possible to rank the menu items (max. 10) in the order we want them to appear in the menu.

Setting up the ranking order



Example of setting up menu items into "USER" menu

As an example we are going to use a direct access into menu items Limit1 and Limit2 (the given example is for Light menu but can be applied also in Profi menu).

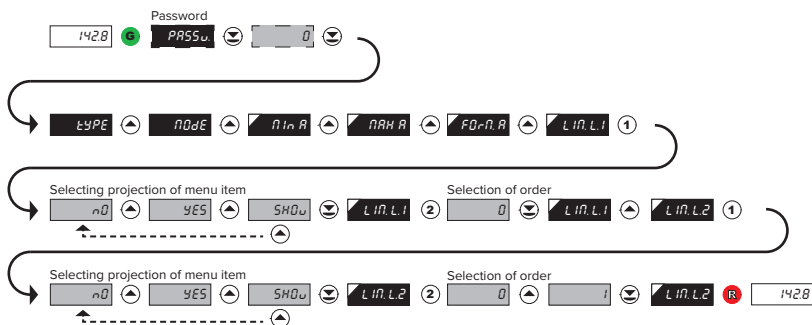

The resulting setting is as follows: After pressing button **R**, „LIM L.1“ is projected. By pressing **☺** you confirm this and you set the desired limit value, alternatively by pressing button **☺** you can go over to setting of „LIM. L.2“ where you repeat the procedure. You can finish the setting up by pressing the **☺** button, by which you save the latest setting and by pressing the **R** you return to the operating mode.

8. METHOD OF MEASURING THE CJC

Instrument with input for temperature measurement with thermocouple allows to set two types of measurement of cold junction.

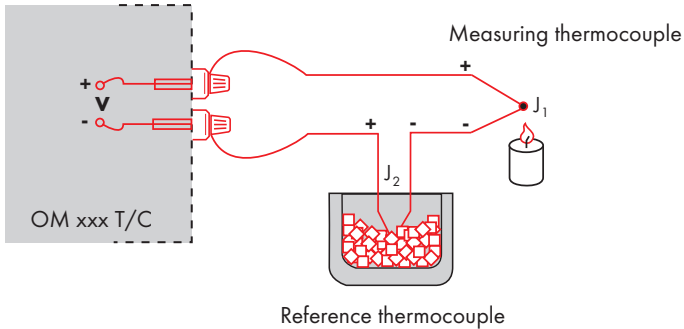

WITH REFERENCE THERMOCOUPLE

- a reference thermocouple may be located in the same place as the measuring instrument or in place with stable temperature/compensation box
- when measuring with reference thermocouple set C0nECC in the instrument menu to InE2tC or EHt2tC
- when using a thermostat (a compensation box or environment with constant temperature) set in the instrument menu CJtEN , its temperature (applies for setting C0nECC to EHt2tC)
- if the reference thermocouple is located in the same environment as the measuring instrument then set in the instrument menu C0nECC to InE2tC . Based on this selection the measurement of the ambient temperature is performed by a sensor located in the instrument terminal board.

WITHOUT REFERENCE THERMOCOUPLE

- inaccuracy originating from the creation of dissimilar thermocouples on the transition point terminal/conductor of the thermocouple is not compensated for in the instrument
- when measuring without reference thermocouple set C0nECC in the instrument menu to InEtC or EHtEtC
- when measuring temperature without reference thermocouple the error in measured data may be as much as 10°C (applies for setting C0nECC to EHtEtC)



The instruments communicate via serial line RS232 or RS485. For communication they use the ASCII protocol. Communication runs in the following format:

- ASCII: 8 bit, no parity, one stop bit
- DIN MessBus: 7 bit, even parity, one stop bit

The transfer rate is adjustable in the instrument menu. The instrument address is set in the instrument menu in the range of 0 ÷ 31. The manufacture setting always presets the ASCII protocol, rate of 9600 Baud, address 00. The type of line used - RS232 / RS485 - is determined by an output board automatically identified by the instrument.

The commands are described in specifications you can find at [na www.orbit.merret.cz/rs](http://na.www.orbit.merret.cz/rs) or in the OM Link program.

DETAILED DESCRIPTION OF COMMUNICATION VIA SERIAL LINE

EVENT	TYPE	PROTOCOL	TRANSMITTED DATA																			
Data solicitation (PC)	232	ASCII	#	A	A	<CR>																
		MessBus	No - data is transmitted permanently																			
	485	ASCII	#	A	A	<CR>																
		MessBus	<SADR>	<ENQ>																		
Data transmission (instrument)	232	ASCII	>	D	(D)	(D)	(D)	(D)	(D)	(D)	(D)	(D)	(D)	(D)	(D)	(D)	(D)	(D)	(D)	<CR>		
		MessBus	<STX>	D	(D)	(D)	(D)	(D)	(D)	(D)	(D)	(D)	(D)	(D)	(D)	(D)	(D)	(D)	(D)	(D)	<ETX>	<BCC>
	485	ASCII	>	D	(D)	(D)	(D)	(D)	(D)	(D)	(D)	(D)	(D)	(D)	(D)	(D)	(D)	(D)	(D)	(D)	<CR>	
		MessBus	<STX>	D	(D)	(D)	(D)	(D)	(D)	(D)	(D)	(D)	(D)	(D)	(D)	(D)	(D)	(D)	(D)	(D)	<ETX>	<BCC>
Confirmation of data acceptance (PC) OK	485	MessBus	<DLE>	1																		
Confirmation of data acceptance (PC) Bad			<NAK>																			
Sending address (PC) prior command			<EADR>	<ENQ>																		
Confirmation of address (instrument)			<SADR>	<ENQ>																		
Command transmission (PC)	232	ASCII	#	A	A	N	P	(D)	(D)	(D)	(D)	(D)	(D)	(D)	(D)	(D)	(D)	(D)	(D)	<CR>		
		MessBus	<STX>	\$	N	P	(D)	(D)	(D)	(D)	(D)	(D)	(D)	(D)	(D)	(D)	(D)	(D)	(D)	<ETX>	<BCC>	
	485	ASCII	#	A	A	N	P	(D)	(D)	(D)	(D)	(D)	(D)	(D)	(D)	(D)	(D)	(D)	(D)	<CR>		
		MessBus	<STX>	\$	N	P	(D)	(D)	(D)	(D)	(D)	(D)	(D)	(D)	(D)	(D)	(D)	(D)	(D)	<ETX>	<BCC>	
Command confirmation (instrument)	232	ASCII	OK	!	A	A	<CR>															
			Bad	?	A	A	<CR>															
		Messbus		No - data is transmitted permanently																		
		485	ASCII	OK	!	A	A	<CR>														
	Bad			?	A	A	<CR>															
	Mess-Bus		OK	<DLE>	1																	
			Bad	<NAK>																		
	Instrument identification			#	A	A	1	Y	<CR>													
HW identification			#	A	A	1	Z	<CR>														
One-time transmission			#	A	A	7	X	<CR>														
Repeated transmission			#	A	A	8	X	<CR>														

9. DATA PROTOCOL

LEGEND

SIGN	RANGE	DESCRIPTION
#	35 23 _H	Command beginning
A A	0...31	Two characters of instrument address (sent in ASCII - tens and units, e.g. "01", "99" universal)
<CR>	13 0D _H	Carriage return
<SP>	32 20 _H	Space
N, P		Number and command - command code
D		Data - usually characters "0"..."9", "-", ".", ":", "(D) - dp, and (-) may prolong data
R	30 _H ...3F _H	Relay and tare status
!	33 21 _H	Positive confirmation of command (ok)
?	63 3F _H	Negative confirmation of command (point)
>	62 3E _H	Beginning of transmitted data
<STX>	2 02 _H	Beginning of text
<ETX>	3 03 _H	End of text
<SADR>	adresa +60 _H	Prompt to send from address
<EADR>	adresa +40 _H	Prompt to accept command at address
<ENQ>	5 05 _H	Terminate address
<DLE>1	16 49 10 _H 31 _H	Confirm correct statement
<NAK>	21 15 _H	Confirm error statement
<BCC>		Check sum -XOR

RELAYS, TARE

SIGN	RELAY 1	RELAY 2	TARE	CHANGE RELAY 3/4
P	0	0	0	0
Q	1	0	0	0
R	0	1	0	0
S	1	1	0	0
T	0	0	1	0
U	1	0	1	0
V	0	1	1	0
W	1	1	1	0
p	0	0	0	1
q	1	0	0	1
r	0	1	0	1
s	1	1	0	1
t	0	0	1	1
u	1	0	1	1
v	0	1	1	1
w	1	1	1	1

Relay status is generated by command #AA6X <CR>. The instrument immediately returns the value in the format >HH <CR>, where HH is value in HEX format and range 00H...FFH. The lowest bit stands for „Relay 1“, the highest for „Relay 8“

ERROR	CAUSE	ELIMINATION
<i>E. d. U_n</i>	Number is too small (large negative) to be displayed	change DP setting, channel constant setting
<i>E. d. U_u</i>	Number is too large to be displayed	change DP setting, channel constant setting
<i>E. t. U_n</i>	Number is outside the table range	increase table values, change input setting (channel constant setting)
<i>E. t. U_u</i>	Number is outside the table range	increase table values, change input setting (channel constant setting)
<i>E. l. U_n</i>	Input quantity is larger than permitted input quantity range	change input signal value or input (range) setting
<i>E. l. U_u</i>	Input quantity is larger than permitted input quantity range	change input signal value or input (range) setting
<i>E. H_u</i>	A part of the instrument does not work properly	send the instrument for repair
<i>E. EE</i>	Data in EEPROM corrupted	perform restoration of manufacture setting, upon repeated error statement send instrument for repair
<i>E. SEt</i>	Data in EEPROM outside the range	perform restoration of manufacture setting, upon repeated error statement send instrument for repair
<i>E. CLr.</i>	Memory was empty (presetting carried out)	upon repeated error statement send instrument for repair, possible failure in calibration
<i>E. OUT</i>	Analogue output current loop disconnected	check wire connection

11. TABLE OF SIGNS



The instrument allows to add two descriptive characters to the classic numeric formats (at the expense of the number of displayed places). The setting is performed by means of a shifted ASCII code. Upon modification the first two places display the entered characters and the last two places the code of the relevant symbol from 0 to 95. Numeric value of given character equals the sum of the numbers on both axes of the table.

Description is cancelled by entering characters with code 00

	0	1	2	3	4	5	6	7		0	1	2	3	4	5	6	7
0		Q	"	#	\$	%	&	'	0	!	"	#	\$	%	&	'	
8	:	;	#	+	,	-	.	/	8	()	*	+	,	-	.	/
16	0	1	2	3	4	5	6	7	16	0	1	2	3	4	5	6	7
24	8	9	VA	Vr	<	=	>	?	24	8	9	VA	Vr	<	=	>	?
32	P	A	B	C	D	E	F	G	32	@	A	B	C	D	E	F	G
40	H	I	J	K	L	M	N	O	40	H	I	J	K	L	M	N	O
48	P	Q	R	S	T	U	V	W	48	P	Q	R	S	T	U	V	W
56	X	Y	Z	[\]	^	_	56	X	Y	Z	[\]	^	_
64	`	a	b	c	d	e	f	g	64	`	a	b	c	d	e	f	g
72	h	i	j	k	l	m	n	o	72	h	i	j	k	l	m	n	o
80	P	Q	r	s	t	u	v	w	80	p	q	r	s	t	u	v	w
88	X	Y	Z	{		}	~		88	x	y	z	{		}	~	



Front view

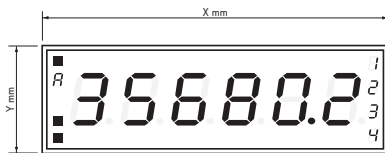

Side view

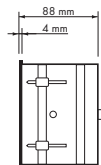

Panel cutout

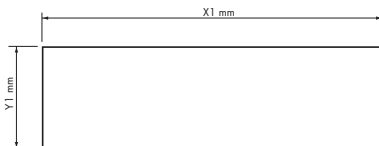

Panel thickness: 0,5 ... 50 mm

Height	X	Y	X1	Y1
57-6	375	119	367	111
100-4	465	181	457	173
100-6	651	181	643	173
125-4	539	237	531	228
125-6	754	237	746	228

Wall mounting

Our large displays are supplied along with a wall mount holder as shown in the the drawing.

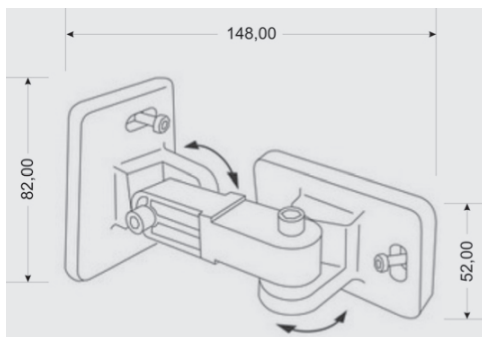

13. TECHNICAL DATA

INPUT

range is adjustable

±60 mV	>100 MΩ
±150 mV	>100 MΩ
±300 mV	>100 MΩ
±1200 mV	>100 MΩ

DC

Input U
Input U
Input U
Input U

range is adjustable

0/4...20 mA	< 400 mV
±2 V	1 MΩ
±5 V	1 MΩ
±10 V	1 MΩ
±40 V	1 MΩ

PM

Input I
Input U
Input U
Input U
Input U

range is adjustable

0...100 Ω
0...1 kΩ
0...10 kΩ
0...100 kΩ

OHM

Connection:

2, 3 or 4 wire

Pt xxxx

-200°...850°C

Pt xxxx/3910 ppm

-200°...1 100°C

Ni xxxx

-50°...250°C

Cu/4260 ppm

-50°...200°C

Cu/4280 ppm

-200°...200°C

Type Pt:

EU > 100/500/1 000 Ω, with 3 850 ppm/°C

US > 100 Ω, with 3 920 ppm/°C

RU > 50/100 Ω, with 3 910 ppm/°C

Type Ni:

Ni 1 000/ Ni 10 000 with 5 000/6 180 ppm/°C

Type Cu:

Cu 500/ Cu 100 with 4 260/4 280 ppm/°C

Connection:

2, 3 or 4 wire

RTD

T/C

range is adjustable in configuration menu

Type:

J (Fe-CuNi) -200°...900°C

K (NiCr-Ni) -200°...1 300°C

T (Cu-CuNi) -200°...400°C

E (NiCr-CuNi) -200°...690°C

B (PtRh30-PtRh6) 300°...1 820°C

S (PtRh10-Pt) -50°...1 760°C

R (Pt13Rh-Pt) -50°...1 740°C

N (Omega alloy) -200°...1 300°C

L (Fe-CuNi) -200°...900°C

DU

Voltage of lin. pot.

2,5 VDC/6 mA
min. potentiometer resistance is 500 Ω

INPUT - CHANNEL B

Range:

0/4...20 mA	< 400 mV
±2 V	1 MΩ
±5 V	1 MΩ
±10 V	1 MΩ
±40 V	1 MΩ

PM

Input I
Input U
Input U
Input U
Input U

INPUT - CHANNEL C

Range:

0/4...20 mA	< 400 mV
±2 V	1 MΩ
±5 V	1 MΩ
±10 V	1 MΩ
±40 V	1 MΩ

PM

Input I
Input U
Input U
Input U
Input U

INPUT - CHANNEL D

Range:

0/4...20 mA	< 400 mV
±2 V	1 MΩ
±5 V	1 MΩ
±10 V	1 MΩ
±40 V	1 MΩ

PM

Input I
Input U
Input U
Input U
Input U

PROJECTION

Display:

999999,
4 (100/125 mm) or 6 digit (57/100/125 mm)
Three-color 7 segment LED - red/green/orange
High bright singles LED - red or green
(1300 mcd)

Projection:

-999...9999 or -99999...999999

Decimal point:

adjustable - in menu

Brightness:

adjustable - in menu

INSTRUMENT ACCURACY

TC:

50 ppm/°C

Accuracy:

±0,1 % of range + 1 digit

±0,15 % of range + 1 digit

Above accuracies apply for projection 9999

RTD, T/C

Resolution:

0,01°/0,1°/1°

Rate:

0,1...40 measurements/s**

Overload capacity:

10x (t < 100 ms) not for 500 V and 5 A,

2x (long-term)

Linearisation:

by linear interpolation in 50 points

- solely via OM Link

Digital filters:

Averaging, Floating average, Exponential filter, Rounding

Comp. of conduct:

max. 40 Ω/100 Ω **RTD**

Comp. of cold junct.:adjustable

T/C

Functions:

0°...99°C or automatic
Tare - display resetting
Hold - stop measuring (at contact)
Lock - control key locking
MM - min/max value
Mathematic functions

OM Link:

company communication interface for setting, operation and update of instrument SW

Watch-dog:

reset after 400 ms

Calibration:

at 25°C and 40% of r.h.

COMPARATOR

Type:

digital, adjustable in menu

Mode:

Hysteresis, From, Dosing

Limita:

-99999...999999

Hysteresis:

0...999999

Delay:

0...99,9 s

Outputs:

4x relays with switch-on contact (Form A)
(230 VAC/30 VDC, 3 A)*
4x open collectors (30 VDC/100 mA)

Relay:

1/8 HP 277 VAC, 1/10 HP 125 V, Pilot Duty D300

DATA OUTPUTS

Protocols: ASCII, DIN MessBus, MODBUS, PROBUS
Data format: 8 bit + no parity + 1 stop bit (ASCII)
 7 bit + even parity + 1 stop bit (MessBus)
Rate: 600...230 400 Baud
 9 600 Baud...12 Mbaud (PROFIBUS)
RS 232: isolated, two-way communication
RS 485: isolated, two-way communication,
 addressing (max. 31 instruments)
PROFIBUS Data protocol SIEMENS

ANALOG OUTPUT

Type: isolated, programmable with 12 bits D/A converter, analogoutput corresponds with displayed data, type and range are adjustable
Non-linearity: 0,1% of range
TC: 15 ppm/°C
Rate: response to change of value < 1 ms
Voltage: 0...2 V/5 V/10 V/±10 V
Current: 0...5/20 mA/4...200 mA
 - compensation of conduct to 500 Ω /12 V
 or 1 000 Ω/24 V

EXCITATION

Adjustable: 5...24 VDC/max. 2,5 W, isolated

POWER SUPPLY

Options: 10...30 V AC/DC, max. 27 VA, isolated
 PF ≥ 0,4, I_{gr} > 75 A/2 ms
 fuse inside (T 4A)
 80...250 V AC/DC, max. 27 VA, isolated
 PF ≥ 0,4, I_{gr} > 475 A/2 ms
 fuse inside (T 4A)

MECHANIC PROPERTIES

Material: anodized aluminum, black
Dimensions: see chapter 13
Panel cut-out: see chapter 13

OPERATING CONDITIONS

Connection: through cable bushings to terminal boards inside the instrument, conductor section up to < 1,5 mm² /< 2,5 mm²
Stabilisation period: within 15 minutes after switch-on
Working temp.: -20° ...60°C
Storage temp.: -20° ...85°C
Cover: IP64
Construction: safety class I
Overvoltage cat.: EN 61010-1, A2
Dielectric strength: 4 kVAC after 1 min between supply and input
 4 kVAC after 1 min between supply and analog output
 4 kVAC after 1 min between supply and relay output
 2,5 kVAC after 1 min between supply and analog output for pollution degree II, measurement cat. III
Insulation resist.: instrum. power supply > 670 V (PI), 300 V (DI)
 Input/output > 300 V (PI), 150 (DI)
EMC: EN 61326-1

PI - Primary insulation, DI - Double insulation

**Table of rate of measurement in relation to number of inputs

Channels/Rate	40	20	10	5	2	1	0,5	0,2	0,1
No.of channels: 1 (Type: DC, PM, DU)	40,00	20,00	10,00	5,00	2,00	1,00	0,50	0,20	0,10
No.of channels: 2	5,00	2,50	1,25	1,00	0,62	0,38	0,22	0,09	0,05
No.of channels: 3	3,33	1,66	0,83	0,66	0,42	0,26	0,14	0,06	0,03
No.of channels: 4	2,50	1,25	0,62	0,50	0,31	0,19	0,11	0,05	0,02
No.of channels: 1 (Type: OHM, RTD, T/C)	5,00	2,50	1,25	1,00	0,62	0,38	0,22	0,09	0,05
No.of channels: 2	3,33	1,066	0,83	0,66	0,42	0,26	0,14	0,06	0,03
No.of channels: 3	2,50	1,25	0,62	0,50	0,31	0,19	0,11	0,05	0,02
No.of channels: 4	2,00	1,00	0,50	0,40	0,25	0,15	0,08	0,04	0,02

* values apply for resistance load

14. CERTIFICATE OF GUARANTEE



Product **OMD 202UNI** **B**
Type
Manufacturing No.
Date of sale

WARRANTY

A guarantee period of 60 months from the date of sale to the user applies to this instrument.
Defects occurring during this period due to manufacture error or due to material faults shall be eliminated free of charge.

For quality, function and construction of the instrument the guarantee shall apply provided that the instrument was connected and used in compliance with the instructions for use.

The guarantee shall not apply to defects caused by:

- mechanic damage
- transportation
- intervention of unqualified person incl. the user
- unavoidable event
- other unprofessional interventions

The manufacturer performs guarantee and post.guarantee repairs unless provided for otherwise.

Y E

Stamp, signature



ES DECLARATION OF CONFORMITY

Company ORBIT MERRET, spol. s r.o.
Klánova 81/141, 142 00 Prague 4, Czech Republic, IDNo.: 00551309

Manufactured ORBIT MERRET, spol. s r.o.
Vodňanská 675/30, 198 00 Prague 9, Czech Republic

declares at its explicit responsibility that the product presented hereunder meets all technical requirements, is safe for use when utilised under the terms and conditions determined by ORBIT MERRET, spol.s r.o. and that our company has taken all measures to ensure conformity of all products of the types referred-to hereunder, which are being brought out to the market, with technical documentation and requirements of the appurtenant Czech statutory orders.

Product 4/6-digit programmable large display

Type OMD 202

Version UNI, PWR, UQC, RS

This has been designed and manufactured in line with requirements of

Low-voltage electrical equipment (directive no. 2014/35/EU)
Electromagnetic compatibility (directive no. 2014/30/EU)

The product qualities are in conformity with harmonized standard

El. safety: EN 61010-1
EMC: EN 61326-1
Electronic measuring, control and laboratory devices – Requirements for EMC “Industrial use”
EN 50131-1, cap. 14 and cap. 15, EN 61000-4-2, EN 61000-4-3, EN 61000-4-4, EN 61000-4-5, EN 61000-4-6, EN 61000-4-8, EN 61000-4-11, EN 61000-3-2, EN 61000-3-3, EN 55022, cap. 5 and cap. 6

The product is furnished with CE label issued in 2001.

As documentation serve the protocols of authorized and accredited organizations

EMC MoD, Testing institute of technical devices, protocol no. 164/11-142/2012 of 24/08/2012
MoD, Testing institute of technical devices, protocol no. 164/11-145/2012 of 24/08/2012

Place and date of issue: Prague, 19. Juli 2009

Miroslav Hackl
Company representative





ORBIT MERRET, spol. s r. o.
Vodňanská 675/30
198 00 Praha 9
Czech Republic

tel.: +420 281 040 200
fax.: +420 281 040 299
orbit@merret.eu

www.orbit.merret.eu

