

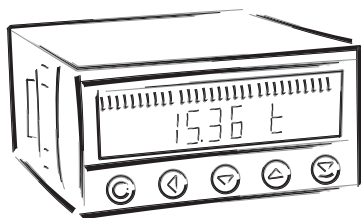

OMB 402UNI

4 DIGIT PROGRAMMABLE UNIVERSAL BARGRAPH

DC VOLTMETER/AMMETER
PROCESS MONITOR
OHMMETER
THERMOMETER FOR PT/NI/CU
THERMOMETER FOR THERMOCOUPLES
DISPLAYS FOR LIN. POTENTIOMETERS





SAFETY INSTRUCTIONS

Please, read the enclosed safety instructions carefully and observe them!
These instruments should be safeguarded by isolated or common fuses (breakers)
For safety information the EN 61 010-1 + A2 standard must be observed.
This instrument is not explosion-safe!

TECHNICAL DATA

Measuring instruments of the OMB 402 series conform to the European regulation 89/336/EWG.

The instruments are up to the following European standards:

EN 61010-1 Electrical safety

EN 61326-1 Electronic measuring, control and laboratory devices – Requirements for EMC "Industrial use"

Seismic capacity:

IEC 980: 1993, čl. 6

The instruments are applicable for unlimited use in agricultural and industrial areas.

CONNECTION

Supply of energy from the main line has to be isolated from the measuring leads.



ORBIT MERRET, spol. s r.o.

Vodnanská 675/30
198 00 Prague 9
Czech Republic

Tel: +420 - 281 040 200
Fax: +420 - 281 040 299
e-mail: orbit@merret.eu
www.orbit.merret.eu



1. CONTENTS	3
2. INSTRUMENT DESCRIPTION	4
3. INSTRUMENT CONNECTION	6
Measuring ranges	6
Termination of RS 485 communication line	6
Instrument connection	7
Recommended connection of sensors	8
4. INSTRUMENT SETTING	10
Symbols used in the instructions	12
Setting the DP and the {} sign	12
Control keys function	13
Setting/permitting items into 'USER' menu	13
5. SETTING "LIGHT" MENU	14
5.0 Description "LIGHT" menu	14
Setting input - Type "DC"	18
Setting input - Type "PM"	20
Setting input - Type "OHM"	22
Setting input - Type "RTD - Pt"	24
Setting input - Type "RTD - Ni"	26
Setting input - Type "T/C"	28
Setting input - Type "DU"	30
Setting input - Type "RTD - Cu"	32
Setting Limits	34
Setting analog output	36
Selection of bargraph projection	38
Selection of programming menu „LIGHT"/„PROFI"	40
Restoration of manufacture setting	40
Calibration - input range (DU)	41
Selection of instrument menu language version	42
Setting new access password	42
Instrument identification	43
6. SETTING "PROFI" MENU	44
6.0 Description of "PROFI" menu	44
6.1 "PROFI" menu - INPUT	
6.1.1 Resetting internal values	44
6.1.2 Setting measuring type, range, mode, rate	47
6.1.3 Setting the Real Time	53
6.1.4 External input function selection	53
6.1.5 Optional accessory functions of the keys	54
6.2 "PROFI" menu - CHANNEL	
6.2.1 Setting measuring parameters (projection, filters, decimal point, description)	58
6.2.2 Setting mathematic functions	62
6.2.3 Selection of evaluation of min/max. value	64
6.3 "PROFI" menu - OUTPUT	
6.3.1 Setting data logging	66
6.3.2 Setting Limits	68
6.3.3 Setting data output	71
6.3.4 Setting analog output	72
6.3.5 Selection of display projection	74
6.3.5 Selection of bargraph projection	75
6.4 "PROFI" menu - SERVICE	
6.4.1 Selection of programming menu „LIGHT"/„PROFI"	80
6.4.2 Restoration manufacture setting	81
6.4.3 Calibration - input range (DU)	82
6.4.4 Selection of instrument menu language version	82
6.4.5 Setting new access password	82
6.4.6 Instrument identification	83
7. SETTING ITEMS INTO "USER" MENU	84
8. METHOD OF MEASURING OF THE COLD JUNCTION	86
9. DATA PROTOCOL	88
10. ERROR STATEMENTS	90
11. TABLE OF SYMBOLS	91
12. TECHNICAL DATA	92
13. INSTRUMENT DIMENSIONS AND INSTALATION	94
14. CERTIFICATE OF GUARANTEE	95

2. INSTRUMENT DESCRIPTION



2.1 DESCRIPTION

The OMB 402 model series are 30 LED, 3-colour panel programmable horizontal bargraph designed for maximum efficiency and user comfort while maintaining their favourable price. Two models are available: UNI and PWR.

Type OMB 402UNI is a multifunction instrument with the option of configuration for 8 various input options, easily configurable in the instrument menu. By further options of input modules it is feasible to measure larger ranges of DC voltage and current or increase the number of inputs up to 4 (applies for PM).

The instrument is based on an 8-bit microcontroller with a multichannel 24-bit sigma-delta converter, which secures high accuracy, stability and easy operation of the instrument.

TYPES AND RANGES

UNI	DC: 0...60/150/300/1200 mV
	PM: 0...5/20 mA/4...20 mA; $\pm 2/\pm 5/\pm 10/\pm 40$ V
	OHM: 0...100 Ω /0...1/10/100 k Ω
	RTD-Pt: Pt 50/100/500/1000
	RTD-Cu: Cu 50/100
	RTD-Ni: Ni 1 000/10 000
	T/C: J/K/T/E/B/S/R/N/L
	DU: Linear potentiometer (min. 500 Ω)
UNI - A	DC: $\pm 0.1/\pm 0.25/\pm 0.5/\pm 2/\pm 5$; $\pm 100/\pm 250/\pm 500$ V
UNI - B	PM: 3x 0...5/20 mA/4...20 mA; $\pm 2/\pm 5/\pm 10/\pm 40$ V

PROGRAMMABLE PROJECTION

Selection:	of type of input and measuring range
Measuring range:	adjustable as fixed or with automatic change
Setting:	manual, optional projection on the display may be set in the menu for both limit values of the input signal, e.g. input 0...20 mA > 0...850,0
Projection:	30-segment LED 3-color bargraph + 6-digit display -9999...9999 [-99999...999999]

COMPENSATION

of conduct:	in the menu it is possible to perform compensation for 2-wire connection
of conduct in probe:	internal connection (conduct resistance in measuring head)
of CJC (T/C):	manual or automatic, in the menu it is possible to perform selection of the type of thermocouple and compensation of cold junctions, which is adjustable or automatic (temperature at the brackets)

LINEARIZATION

Linearization:*	by linear interpolation in 50 points (solely via DM Link)
-----------------	-----------------------------------------------------------

DIGITAL FILTERS

Floating average:	from 2...30 measurements
Exponen. average:	from 2...100 measurements
Arithmetic average:	from 2...100 measurements
Rounding:	setting the projection step for display

MATHEMATIC FUCTIONS

Min/max. value:	registration of min./max. value reached during measurement
Tare:	designed to reset display upon non-zero input signal
Peak value:	the display shows only max. or min. value
Mat. operations:	polynome, $1/x$, logarithm, exponential, power, root, sin x

* only for types DC, PM, DU

EXTERNAL CONTROL

Lock:	control keys blocking
Hold:	display/instrument blocking
Tare:	tare activation/resetting tare to zero
Resetting MM:	resetting min/max value
Memory:	data storage into instrument memory

2.2 OPERATION

The instrument is set and controlled by five control keys located on the front panel. All programmable settings of the instrument are performed in three adjusting modes:

LIGHT	Simple programming menu - contains solely items necessary for instrument setting and is protected by optional number code
PROFI	Complete programming menu - contains complete instrument menu and is protected by optional number code
USER	User programming menu - may contain arbitrary items selected from the programming menu (LIGHT/PROFI), which determine the right (see or change) - access without password

All programmable parameters are stored in the EEPROM memory (they hold even after the instrument is switched off).



Complete instrument operation and setting may be performed via OM Link communication interface, which is a standard equipment of all instruments.

The operation program is freely accessible [www.orbit.merret.eu] and the only requirement is the purchase of OML cable to connect the instrument to PC. It is manufactured in version RS 232 and USB and is compatible with all DRBIT MERRET instruments. Another option for connection is with the aid of data output RS 232 or RS 485 (without the need of the OML cable).

The program OM LINK in „Basic“ version will enable you to connect one instrument with the option of visualization and archiving in PC. The OM Link „Standard“ version has no limitation of the number of instruments connected.

2.3 OPTIONS

Excitation is suitable for supplying power to sensors and transmitters. It has a galvanic separation.

Comparators are assigned to monitor one, two, three or four limit values with relay output. The user may select limits regime: LIMIT/DOSING/FROM-TO. The limits have adjustable hysteresis within the full range of the display as well as selectable delay of the switch-on in the range of 0..99,9 s. Reaching the preset limits is signalled by LED and simultaneously by the switch-on of the relevant relay.

Data outputs are for their rate and accuracy suitable for transmission of the measured data for further projection or directly into the control systems. We offer an isolated RS232 and RS485 with the ASCII or DIN MessBus protocol.

Analog outputs will find their place in applications where further evaluating or processing of measured data is required in external devices. We offer universal analog output with the option of selection of the type of output - voltage/current. The value of analog output corresponds with the displayed data and its type and range are selectable in Menu.

Measured data record is an internal time control of data collection. It is suitable where it is necessary to register measured values. Two modes may be used. FAST is designed for fast storage (40 records/s) of all measured values up to 8 000 records. Second mode is RTC, where data record is governed by Real Time with data storage in a selected time segment and cycle. Up to 250 000 values may be stored in the instrument memory. Data transmission into PC via serial interface RS232/485 and OM Link.

3. INSTRUMENT CONECTION



The instrument supply leads should not be in proximity of the incoming low-potential signals.

Contactors, motors with larger input power should not be in proximity of the instrument.

The leads into the instrument input (measured quantity) should be in sufficient distance from all power leads and appliances. Provided this cannot be secured it is necessary to use shielded leads with connection to ground (bracket E).

The instruments are tested in compliance with standards for use in industrial area, yet we recommend to abide by the above mentioned principles.

MEASURING RANGES

TYPE	INPUT I	INPUT U
DC		0...60/150/300/1 200 mV
PM	0...5/20 mA/4...20 mA	±2/±5/±10/±40 V
DHM	0...100 Ω/0...1/10/100 kΩ	
RTD-Pt	Pt 50/100/500/1 000	
RTD-Cu	Cu 50/100	
RTD-Ni	Ni 1 000/10 000	
T/C	J/K/T/E/B/S/R/N/L	
DU	Linear potentiometer (min. 500 Ω)	

OPTION "A"

TYPE	INPUT I	INPUT U
DC	±0,1/±0,25/±0,5 A to GND [C] ±2/±5 A to GND [B]	±100/±250/±500 V to GND [C]

OPTION "B"

TYPE	INPUT 2, 3, 4/I	INPUT 2, 3, 4/U
PM	0...5/20 mA/4...20 mA	±2/±5/±10/±40 V

Termination of RS 485 communication line

X3 - Termination of communication line RS 485

Full	Significance	Default	Recommendation
1-2	connect L+ to (+) source	terminalconnected	connect at the end of line do not disconnect
3-4	termination of line 120 Ohm	disconnected	
5-6	connect L- to (-) source	terminalconnected	

RS 485 line should have a linear structure - wires (ideally shielded and twisted) should lead from one device to another.

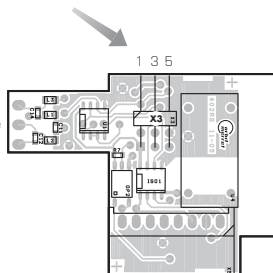

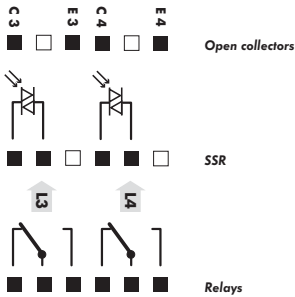

!
Excitation has the minus pole common with the input - the bracket no. 20 - GND and you may set its value by trimmer above the bracket no. 17

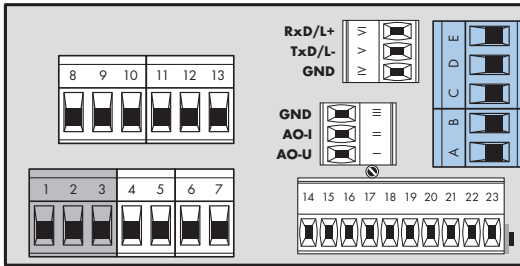

- Option A**
- INPUT - U**
 - GND - U/10,5**
 - GND - 15**
 - INPUT - I**

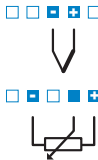
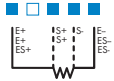
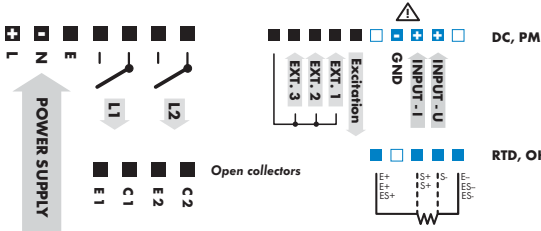

Maximum of 250 mA may be connected to "INPUT - I" (bracket no. 21), i.e. 10-times range overload. Mind the correct connection/mistaking of current - voltage input. Destruction of measuring resistance in current input (15R) may occur.

3. INSTRUMENT CONNECTION

Example connection of a 2-wire sensor with current signal output powered by instrument's excitation

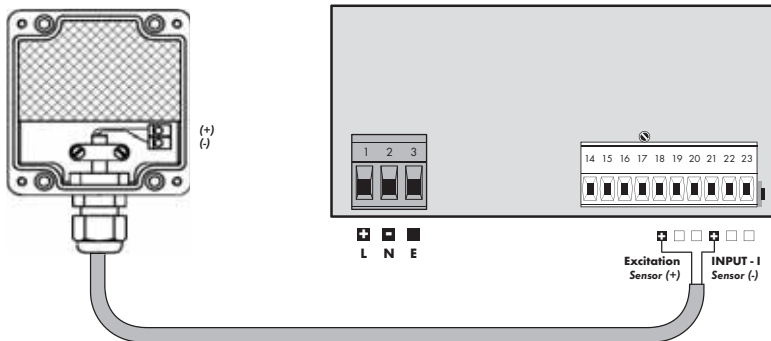

Example connection of a 3-wire sensor with current signal output powered by instrument's excitation

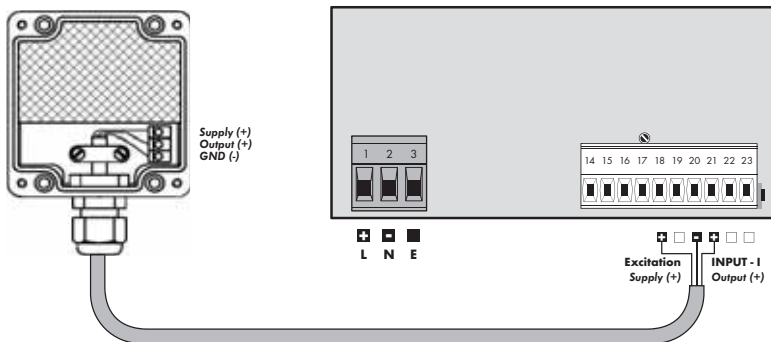

Example connection of 3-wire sensor with voltage signal output powered by instrument's excitation

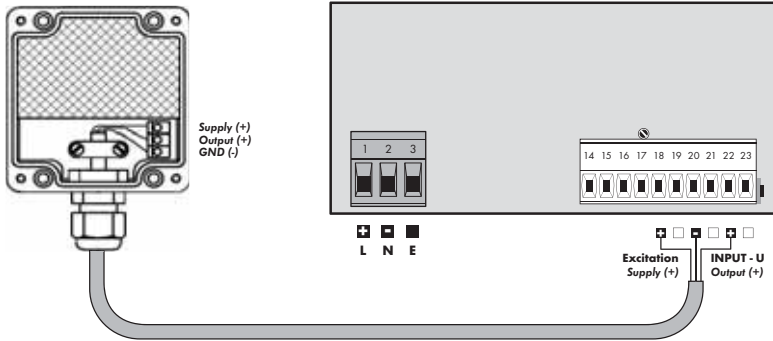

Example connection of resistance measurement using 4 wires

By connecting resistor R^* we eliminate error message E. I.Ov. (input overflow) when the measured resistance is disconnected

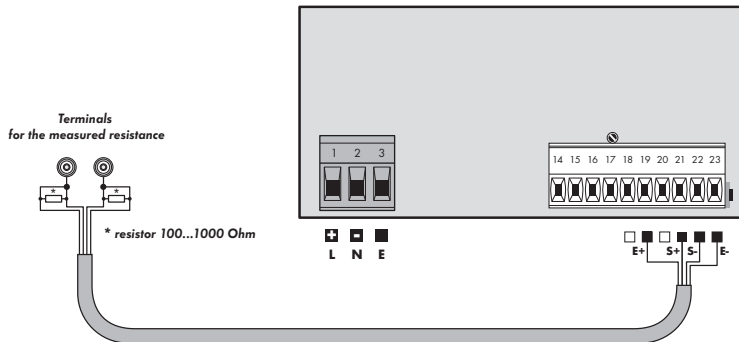



SETTING **PROFI**

For expert users

Complete instrument menu

Access is password protected

Possibility to arrange items of the **USER MENU**

Tree menu structure

SETTING **LIGHT**

For trained users

Only items necessary for instrument setting

Access is password protected

Possibility to arrange items of the **USER MENU**

Linear menu structure

SETTING **USER**

For user operation

Menu items are set by the user (Profi/Light) as per request

Access is not password protected

Optional menu structure either tree (PROFI) or linear (LIGHT)

4.1 SETTING

The instrument is set and controlled by five control keys located on the front panel. All programmable settings of the instrument are performed in three adjusting modes:

- LIGHT** **Simple programming menu**
- contains solely items necessary for instrument setting and is protected by optional number code
- PROFI** **Complete programming menu**
- contains complete instrument menu and is protected by optional number code
- USER** **User programming menu**
- may contain arbitrary items selected from the programming menu (LIGHT/PROFI), which determine the right (see or change)
- acces without password

All programmable parameters are stored in the EEPROM memory (they hold even after the instrument is switched off).

Complete instrument operation and setting may be performed via QM Link communication interface, which is a standard equipment of all instruments.

The operation program is freely accessible (www.orbit.merret.eu) and the only requirement is the purchase of QML cable to connect the instrument to PC. It is manufactured in version RS 232 and USB and is compatible with all ORBIT MERRET instruments. Another option for connection is with the aid of data output RS 232 or RS 485 (without the need of the QML cable).

Scheme of processing the measured signal

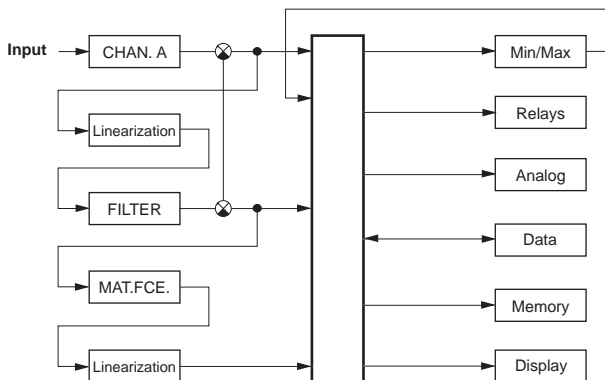

4. INSTRUMENT SETTING

Setting and controlling the instrument is performed by means of 5 control keys located on the front panel. With the aid of these keys it is possible to browse through the operation menu and to select and set required values.

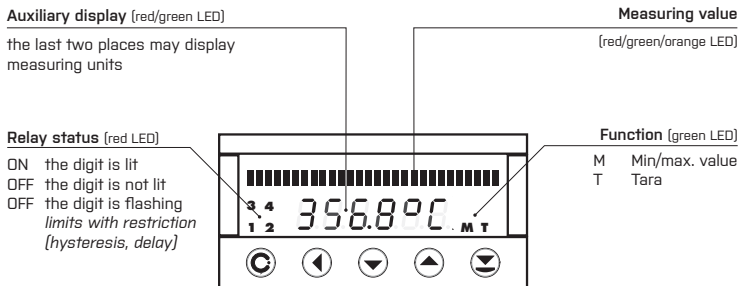

Symbols used in the instructions

DC **PM**
DU **OHM** **RTD** **T/C** Indicates the setting for given type of instrument

DEF values preset from manufacture

 symbol indicates a flashing light (symbol)

 inverted triangle indicates the item that can be placed in USER menu

 broken line indicates a dynamic item, i.e. it is displayed only in particular selection/version

 after pressing the key the set value will not be stored

 after pressing the key the set value will be stored

 30 continues on page 30

Setting the decimal point and the minus sign

DECIMAL POINT

Its selection in the menu, upon modification of the number to be adjusted it is performed by the control key  with transition beyond the highest decade, when the decimal point starts flashing. Positioning is performed by  .

THE MINUS SIGN

Setting the minus sign is performed by the key  on higher decade. When editing the item subtraction must be made from the current number (e.g.: 013 > , on class 100 > -87)

Control keys functions

KEY	MEASUREMENT	MENU	SETTING NUMBERS/SELECTION
	access into USER menu	exit menu	quit editing
	programmable key function	back to previous level	move to higher decade
	programmable key function	move to previous item	move down
	programmable key function	move to next item	move up
	programmable key function	confirm selection	confirm setting/selection
			numeric value is set to zero
	access into LIGHT/PROFI menu		
	direct access into PROFI menu		
		configuration of an item for "USER" menu	
		determine the sequence of items in "USER - LIGHT" menu	

Setting items into „USER" menu

- in **LIGHT** or **PROFI** menu
- no items permitted in **USER** menu from manufacture
- on items marked by inverted triangle

USER

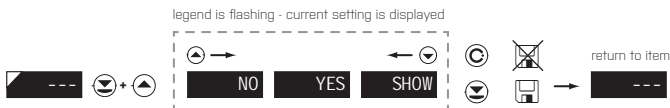

NO	item will not be displayed in USER menu
YES	item will be displayed in USER menu with the option of setting
SHOW	item will be solely displayed in USER menu



SETTING **LIGHT**

For trained users

Only items necessary for instrument setting

Access is password protected

Possibility to arrange items of the **USER MENU**

Linear menu structure

Access password
 1428 PASSW 0

Type of instruments Measuring range
 TYPE PM MODE 4-20mA

RTD OHM
 CONNEC 2-WIRE FORM.A 00000.0
 V/C
 CONNEC EXTJTC C.J.TEM 23 FORM.A 00000.0
 DC PA OHM DU
 MIN.A 0 MAX.A 100 FORM.A 0000.00

Selecting projection and connection

U.M.L1 20 U.M.L2 40 U.M.L3 60 U.M.L4 80
 Option - comparator

TYP.A.O. 4-20mA MIN.A.O. 0 MAX.A.O. 100
 Option - Analog output

Setting bargraph projection - MIN Setting bargraph projection - MAX Setting bargraph colors
 MIN.BG. 0 MAX.BG. 100 COLOR GREEN

Menu type Return to manufacture calibration Return to manufacture setting
 MENU LIGHT RE.CAL. YES RE.SET. TYPE

DU Calibration - only for "DU"
 C.MIN. YES C.MAX. YES

Language selection New password
 LANG. ENGL. PAS.LI. 0

Identification Type of instruments SW. version Input
 IDENT. YES OMB 402UNI 78-001 PM 1428 Return to measuring mode

Preset from manufacture

Password	"0"
Menu	LIGHT
USER menu	off
Setting the items	DEF

!
 Upon delay exceeding 60 s the programming mode is automatically discontinued and the instrument itself restores the measuring mode

5. SETTING LIGHT

1428



PASSW.

0

Entering access password for access into the menu

PASSW. Access into instrument menu

PAS = 0

- access into menu is unrestricted, after releasing keys you automatically move to first item of the menu

PAS > 0

- access into menu is protected by number code

Set "Password" = 42 Example

0 1 2 02 12 22

32 42 TYPE

TYPE

DC PM OHM RTD- Pt RTD-Ni TC

DU RTD- Cu

TYPE Selection of the type of instrument

- primary selection of the type of instrument
- performs default setting **DEF** of values from manufacture, incl. calibration
- **DEF** = „PM“

Menu	Type of instrument
DC	DC voltmeter
PM	Process monitor
OHM	Ohmmeter
RTD-Pt	Thermometer for sensors Pt
RTD-Ni	Thermometer for sensors Ni
TC	Thermometer for thermocouples
DU	Display for lin. potentiometer
RTD-Cu	Thermometer for sensors Cu

Type "PM" Example

DC PM MODE

Type „DC“	18
Type „PM“	20
Type „OHM“	22
Type „RTD-Pt“	24
Type „RTD-Ni“	26
Type „TC“	28
Type „DU“	30
Type „RTD-Cu“	32



5. SETTING PROFI

MEASURING MODE > DC

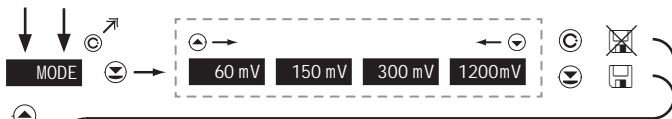

MODE Selection of the instrument measuring range

DEF = 60 mV

DEF = 500 V*

* only for option "A"

Menu	Measuring range
60 mV	±60 mV
150 mV	±150 mV
300 mV	±300 mV
1200mV	±1.2 V
100 V	±100 V
250 V	±250 V
500 V	±500 V
0.10 A	±0.1 A
0.25 A	±0.25 A
0.50 A	±0.5 A
1.00 A	±1 A
5.00 A	±5 A

Range ±150 mV Example

60 mV 150 mV



MIN A Setting display projection for minimum value of input signal

- range of the setting: -99999...999999
- position of the DP does not affect display projection
- the DP is automatically shifted after the value is confirmed

DEF = 0

Projection for 0 mV > MIN A = 0 Example

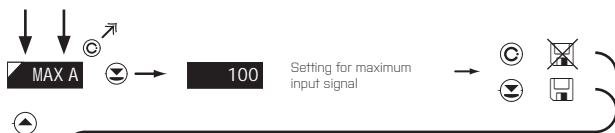

MAX A Setting display projection for maximum value of input signal

signal

- range of the setting: -99999...99999
- position of the DP does not affect display projection

- the DP is automatically shifted after the value is confirmed

DEF = 100

Projection for 150 mV > MAX A = 3500 Example

100	100	100	200	300	400
500	0500	1500	2500	3500	FORM A

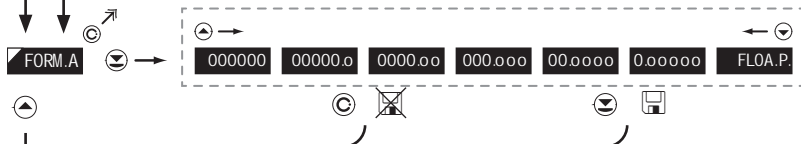

FORM.A Setting projection of the decimal point

DEF = 0000.00

- positioning of the DP is set here in the measuring mode

Projection of DP on display > 00000.0 Example

0000.00	00000.0	MM N.BG
---------	---------	---------

*subsequent item on the menu depends on instrument equipment

5. SETTING LIGHT

MEASURING MODE > PM

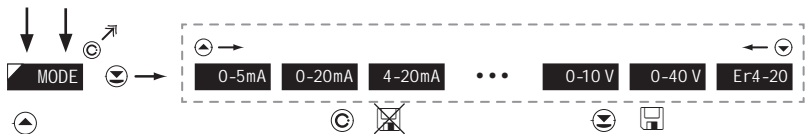

MODE Selection of the instrument measuring range

DEF = 4 - 20 mA

Menu	Measuring range
0-5mA	0...5 mA
0-20mA	0...20 mA
4-20mA	4...20 mA
0-2 V	±2 V
0-5 V	±5 V
0-10 V	±10 V
0-40 V	±40 V
Er4-20	4...20 mA, with error statement of „underfl ow“ upon signal smaller than 3,36 mA

Range 0...20 mA Example

4-20mA 0-20 mA MIN A



MIN A Setting display projection for minimum value of input signal

- range of the setting: -99999...99999
- position of the DP does not affect display projection

- the DP is automatically shifted after the value is confirmed

DEF = 0

Projection for 0 mA > MIN A = -25 Example

0	1	2	3	4	5	MAX A
0.5	1.5	2.5	3.5	4.5	5.5	



MAX A Setting display projection for maximum value of input signal

signal

- range of the setting: -99999...999999
- position of the DP does not affect display projection

- the DP is automatically shifted after the value is confirmed

DEF = 100

Projection for 20 mA > MAX A = 2500 Example

100	100	100	200	300	400
500	0500	1500	2500	FORM.A	

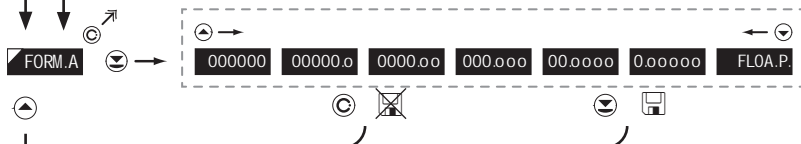

FORM.A Setting projection of the decimal point

- positioning of the DP is set here in the measuring mode

DEF = 0000.00

Projection of DP on display > 00000.0 Example

0000.00	00000.0	MI N.B.G.
---------	---------	-----------

*subsequent item on the menu depends on instrument equipment

5. SETTING LIGHT

MEASURING MODE > OHM

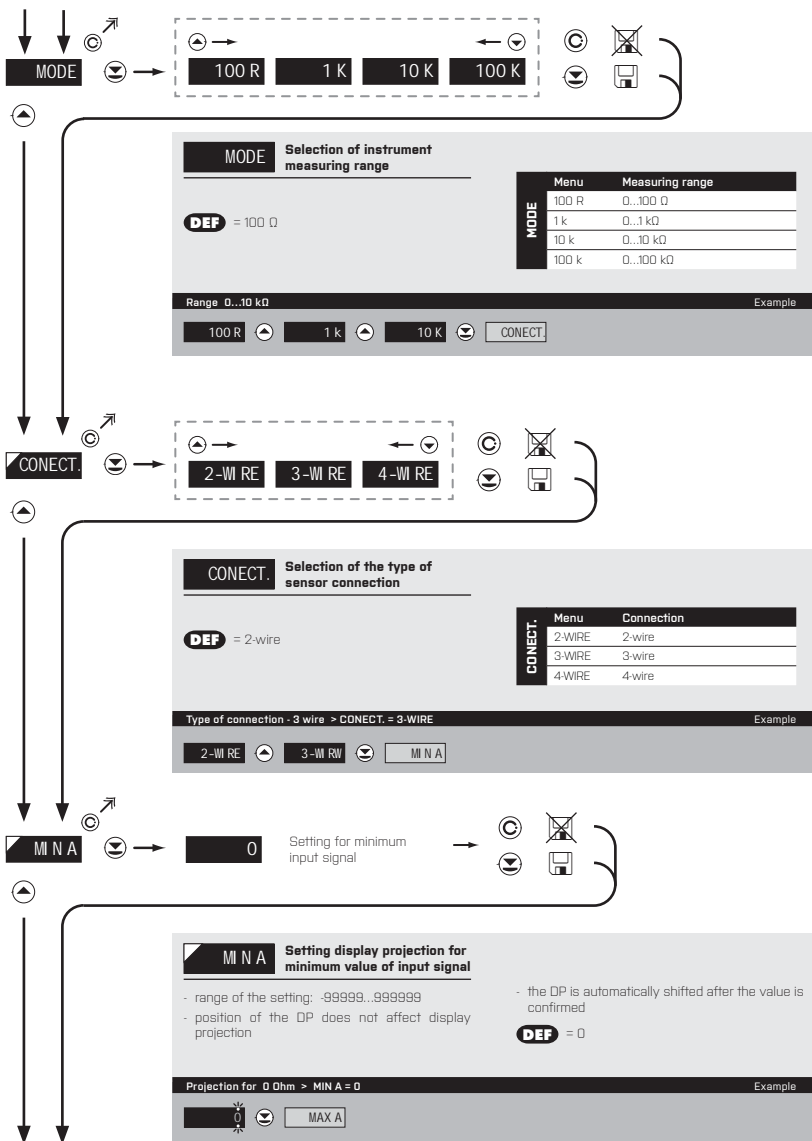



MAX A Setting display projection for maximum value of input signal

- range of the setting: -99999...999999
- position of the DP does not affect display projection

- the DP is automatically shifted after the value is confirmed

DEF = 100

Projection for 10 kOhm > MAX A = 10000 Example

100 100 100 000 0000 00000

10000 FORM.A



FORM.A Setting projection of the decimal point

- positioning of the DP is set here in the measuring mode

DEF = 0000.00

Projection of DP on display > 00000.0 Example

0000.00 00000.0 MI N.BG

*subsequent item on the menu depends on instrument equipment

5. SETTING LIGHT

MEASURING MODE > RTD - Pt

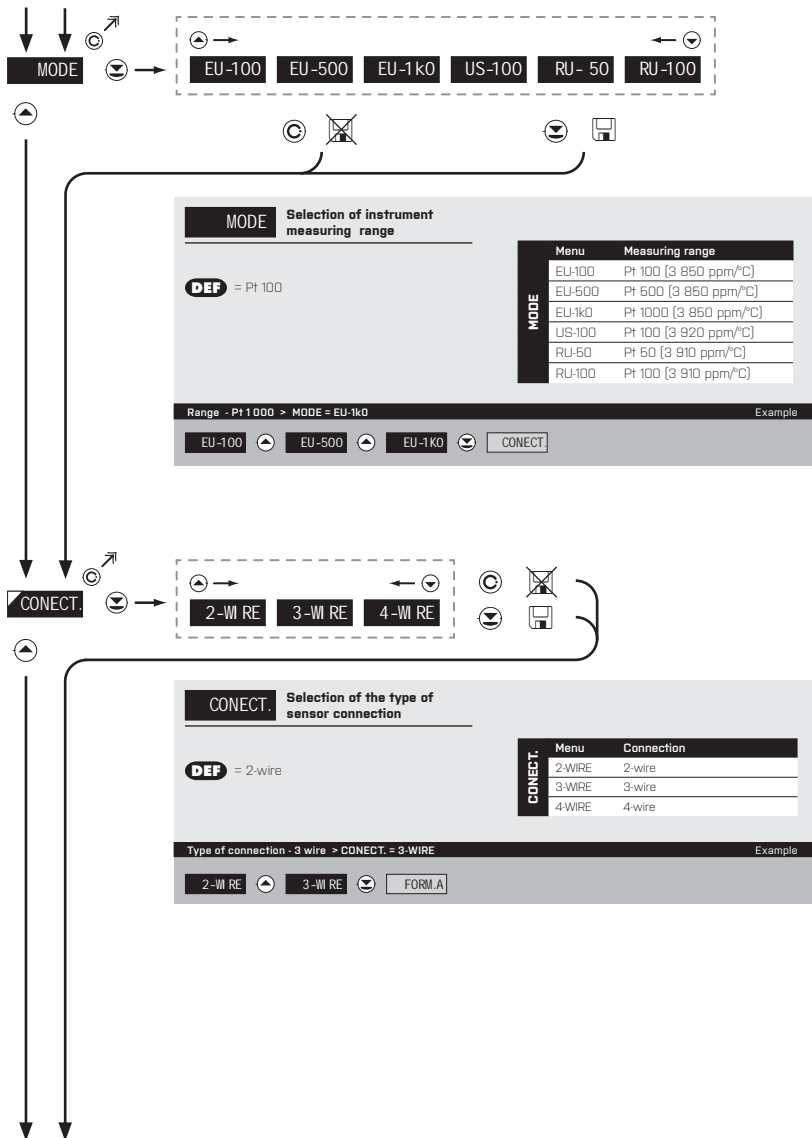

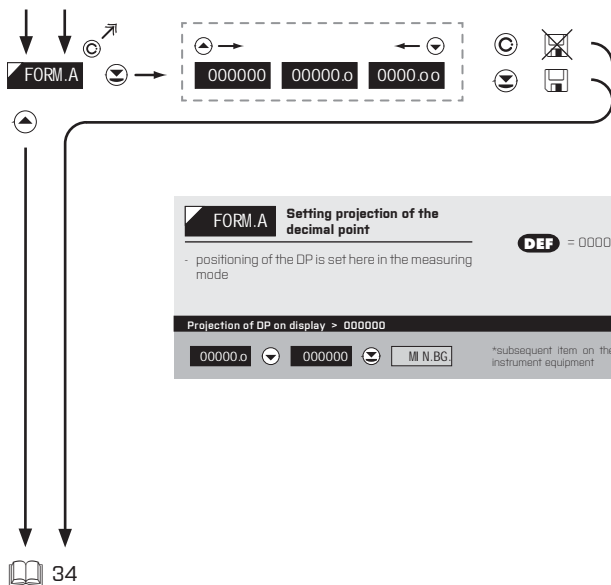

5. SETTING LIGHT

MEASURING MODE > RTD - Ni

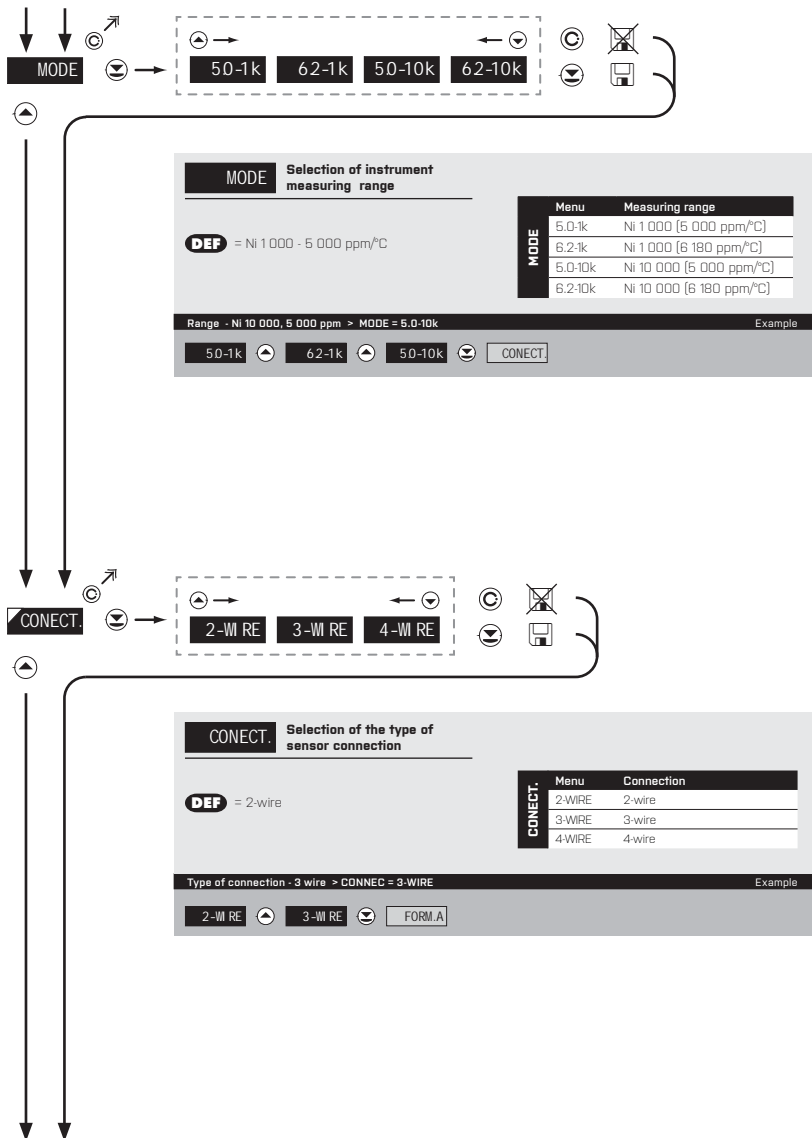

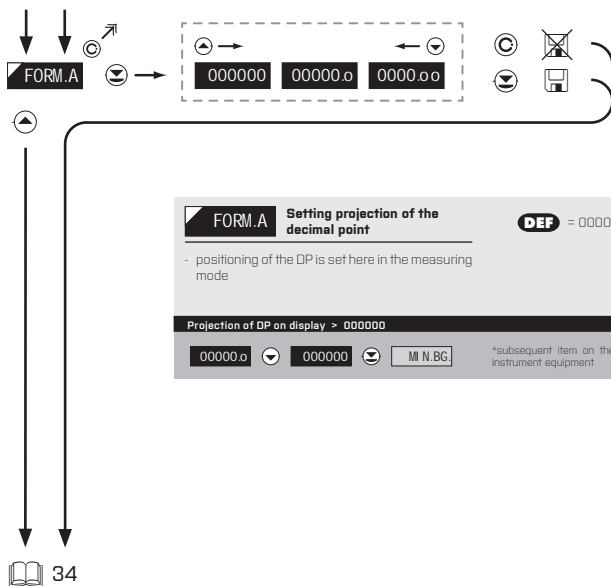

6. SETTING PROFI

MEASURING MODE > T/C

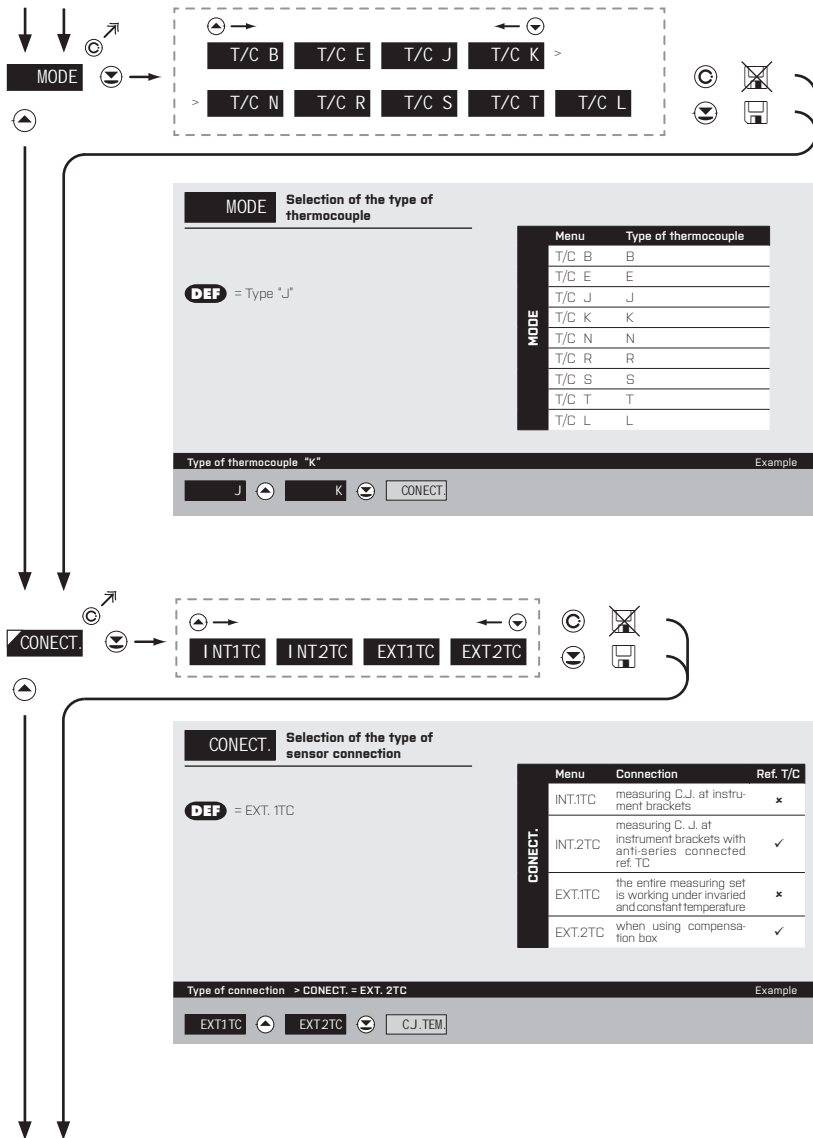

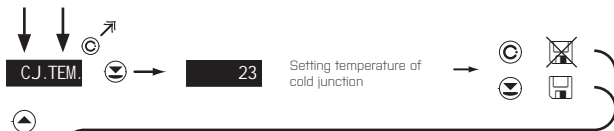

C.J. TEM. Setting temperature of cold junction **DEF** = 23

- range 0...99°C with compensation box

Setting temperature of cold junction > C.J. TEM. = 35 Example

23 24 25 25 35 FORM.A



FORM.A Setting projection of the decimal point **DEF** = 00000.0

- positioning of the DP is set here in the measuring mode

Projection of DP on display > 000000 Example

00000.0 000000 M N.BG *subsequent item on the menu depends on instrument equipment

! For thermocouple type "B" the items **CONNECT.** and **C.J. TEM.** are not available

! Method and procedure of setting the cold junctions is described in separate chapter on page 86

5. SETTING LIGHT

MEASURING MODE > DU



MIN A **Setting display projection for minimum value of input signal**

- range of the setting: -99999...999999
- position of the DP does not affect display projection

- the DP is automatically shifted after the value is confirmed

DEF = 0

Projection for the beginning > MIN A = 0 Example



MAX A **Setting display projection for maximum value of input signal**

- range of the setting: -99999...999999
- position of the DP does not affect display projection

- the DP is automatically shifted after the value is confirmed

DEF = 100

Projection for the end > MAX A = 5000 Example

FORM.A

000000 00000.0 0000.00 000.000 00.0000 0.00000 FLOA.P.

FORM.A **Setting projection of the decimal point**

DEF = 0000.00

- positioning of the DP is set here in the measuring mode

Projection of DP on display > 0000.00 Example

0000.00 M N.B.C. *subsequent item on the menu depends on instrument equipment

34 Calibration of the beginning and the end of range of linear potentiometer is on page 41

5. SETTING LIGHT

MEASURING MODE > RTD - Cu

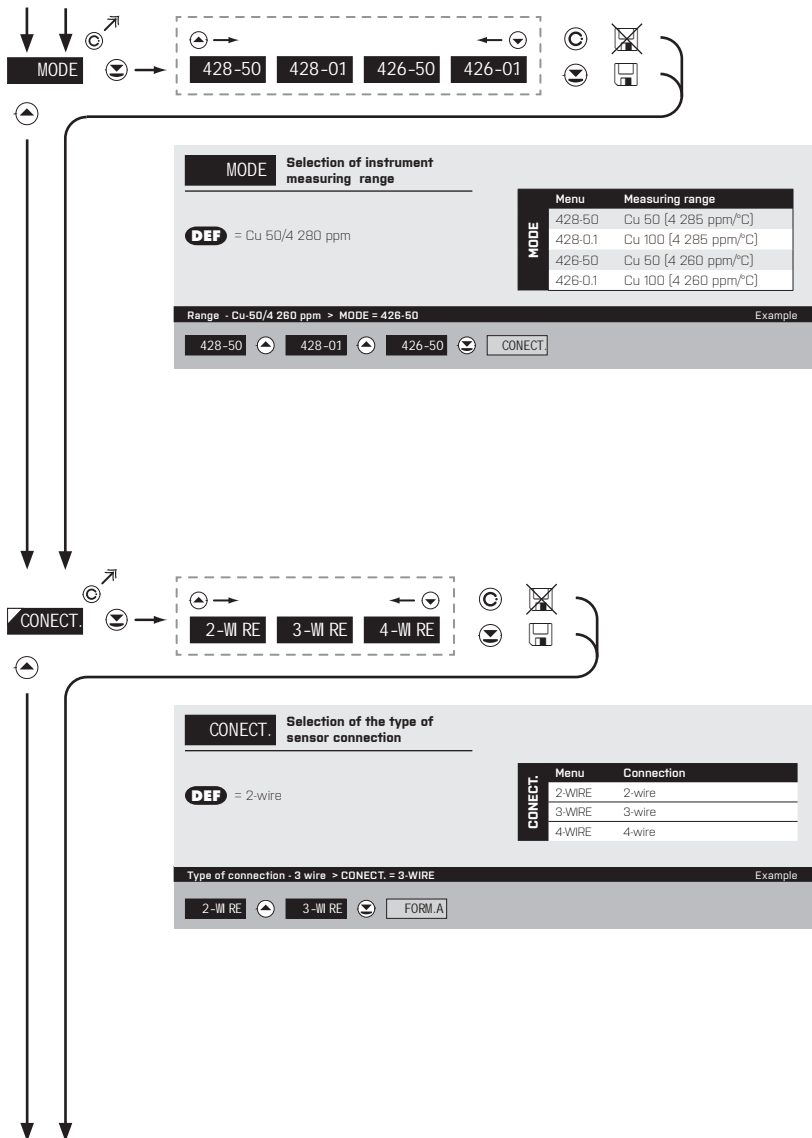

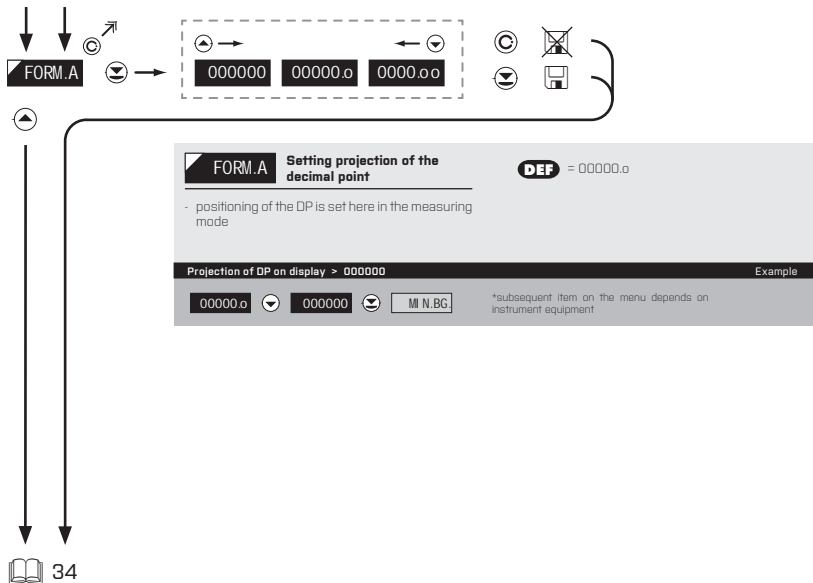

5. SETTING LIGHT

DISPLAYED ONLY WITH OPTIONS > COMPARATORS

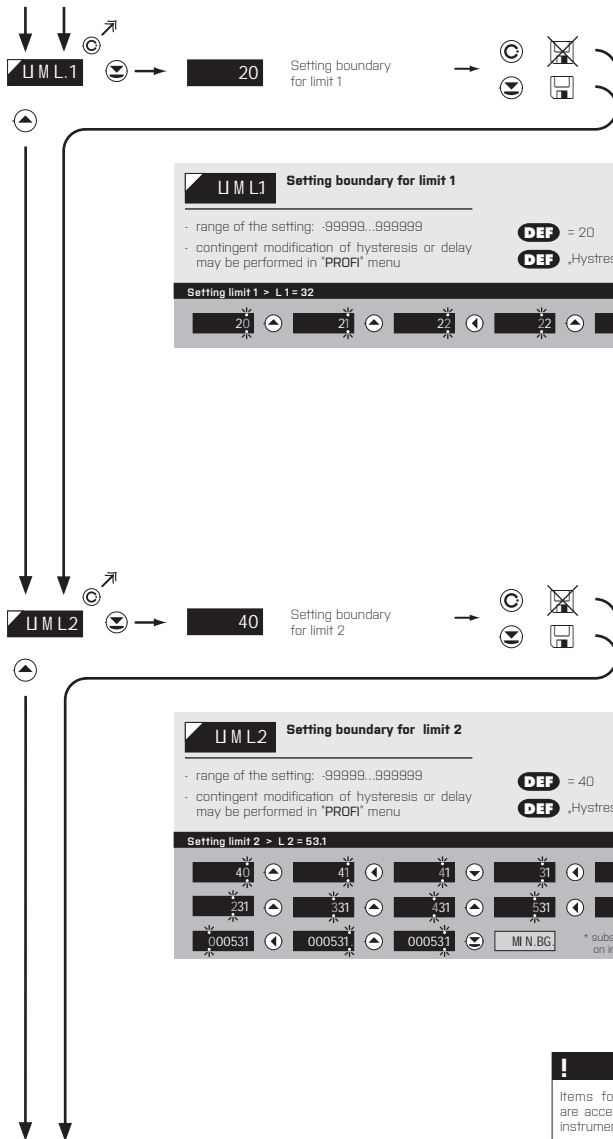

UML1 Setting boundary for limit 1

- range of the setting: -99999...999999
- contingent modification of hysteresis or delay may be performed in 'PROF' menu

DEF = 20
DEF „Hysteresis“=0, „Delay“=0

Setting limit 1 > L1 = 32 Example

20	21	22	22	32	MI N.BG
----	----	----	----	----	---------

UML2 Setting boundary for limit 2

- range of the setting: -99999...999999
- contingent modification of hysteresis or delay may be performed in 'PROF' menu

DEF = 40
DEF „Hysteresis“=0, „Delay“=0

Setting limit 2 > L2 = 53.1 Example

40	41	41	31	031	131
231	331	431	531	0531	00531
000531	000531	000531	MI N.BG	* subsequent item on the menu depends on instrument equipment	

! Items for "Limits" and "Analog output" are accessible only if incorporated in the instrument.

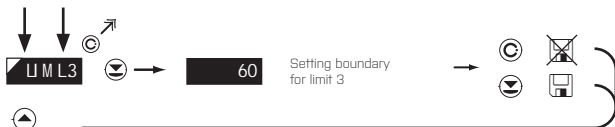

U M L3 Setting boundary for limit 3

- range of the setting: -99999...999999
- contingent modification of hysteresis or delay may be performed in "PROF" menu

DEF = 60
DEF „Hysteresis“=0, „Delay“=0

Setting limit 3 > L 3 = 85 Example

60	61	62	63	64	65
65	75	85	M N.BG	* subsequent item on the menu depends on instrument equipment	



U M L4 Setting boundary for limit 4

- range of the setting: -99999...999999
- contingent modification of hysteresis or delay may be performed in "PROF" menu

DEF = 80
DEF „Hysteresis“=0, „Delay“=0

Setting limit 4 > L 4 = 103 Example

80	81	82	83	83	93
03	003	103	M N.BG	* subsequent item on the menu depends on instrument equipment	

5. SETTING LIGHT

DISPLAYED ONLY WITH OPTIONS > ANALOG OUTPUT

TYP.A.O. Setting the type of analog output

Menu	Range	Description
0-20mA	0..20 mA	
Er4-T	4..20 mA	with error message indication and broken loop indication (<3,6 mA)
4-20T	4..20 mA	with broken loop indication (<3,6 mA)
Er4-20	4..20 mA	with indication of error statement (<3,6 mA)
4-20mA	4..20 mA	
0.5mA	0..5 mA	
0.2 V	0..2 V	
0.5 V	0..5 V	
0-10 V	0..10 V	
+10 V	±10 V	

DEF = 4..20 mA

Type of analog output - 0..10 V > TYP. A.O. = 0-10 V Example

4-20mA 0-5mA 0-2 V 0-5 V 0-10 V **MIN A.O.**

MIN A.O. Assigning the display value to the beginning of the AD range

DEF = 0

- range of the setting: -99999...999999

Display value for the beginning of the AD range > MIN A.O. = 0 Example

0 **MAX A.O.**

!

Items for "Limits" and "Analog output" are accessible only if incorporated in the instrument.



MAX A.O. Assigning the display value to the end of the AD range

- range of the setting: -99999...999999 **DEF** = 100

Display value for the end of the AD range > MAX A.O. = 120 Example

100 100 110 120 MI N.BG.

DISPLAYED ONLY WITH OPTIONS > ANALOG OUTPUT

5. SETTING LIGHT

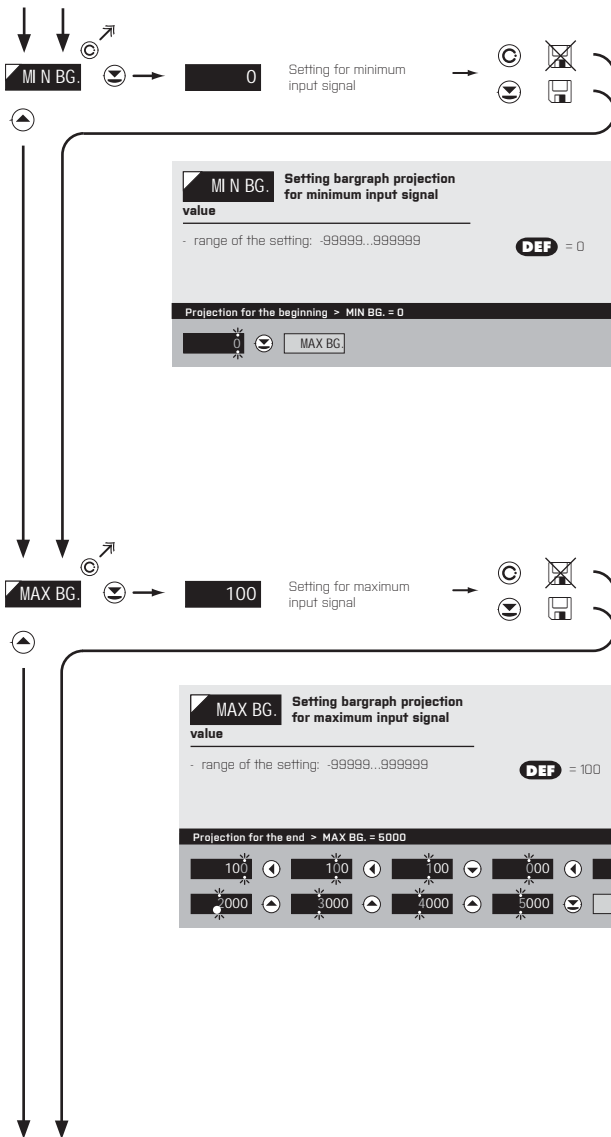



5. SETTING LIGHT

The diagram illustrates the menu structure for setting the instrument. It starts with the **MENU** button, which leads to either **LIGHT** or **PROFI**. From **RE.CAL.**, it leads to **YES**. From **RE.SET.**, it leads to either **TYPE** or **USER**. A table at the bottom left lists various instrument types and their corresponding page numbers.

MENU **Setting the menu type LIGHT/PROFI**

LIGHT > menu LIGHT, a simple menu, which contains only the most essential items necessary for instrument setting
> linear tree structure

PROFI > menu PROF, a complete menu for complete instrument setting
> tree menu structure

DEF = LIGHT

Menu LIGHT > MENU = LIGHT Example

RE.CAL. **Restoration of manufacture calibration**

- in the event of error calibration it is feasible to restore manufacture calibration
- Prior to execution of any modifications you will be asked to confirm your selection (YES)

Restoration of manufacture calibration > RE.CAL. Example

RE.SET. **Restoration of manufacture instrument setting**

- in the event of error setting the manufacture setting may be restored
- restoration is performed for the currently selected type of the instrument input (select "TYPE")
- provided you stored your user setting in the "PROFI" menu, it may also be restored (select "USER")
- loading manufacture calibration and primary setting of items on the menu (DEF)

Restoration of manufacture setting > RE.SET. Example

* subsequent item on the menu depends on instrument equipment

Type "DC"		42
Type "PM"		42
Type "OHM"		42
Type "RTD-Pt"		42
Type "RTD-Ni"		42
Type "T/C"		42
Type "DL"		41
Type "RTD-Cu"		42

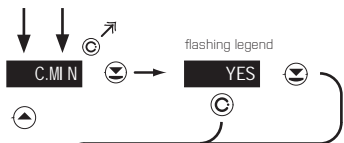

C.MIN Calibration of input range - the potentiometer traveller in initial position Only for type "DU"

- prior confirming the flashing "YES" sign the potentiometer traveller has to be in given idle position

Calibration of the beginning of the range > C. MIN Example

YES

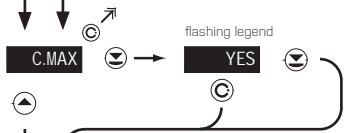

C.MAX Calibration of input range - the potentiometer traveller in end position Only for type "DU"

- prior confirming the flashing "YES" sign the potentiometer traveller has to be in given idle position

Calibration of the end of the range > C. MAX Example

YES

5. SETTING LIGHT

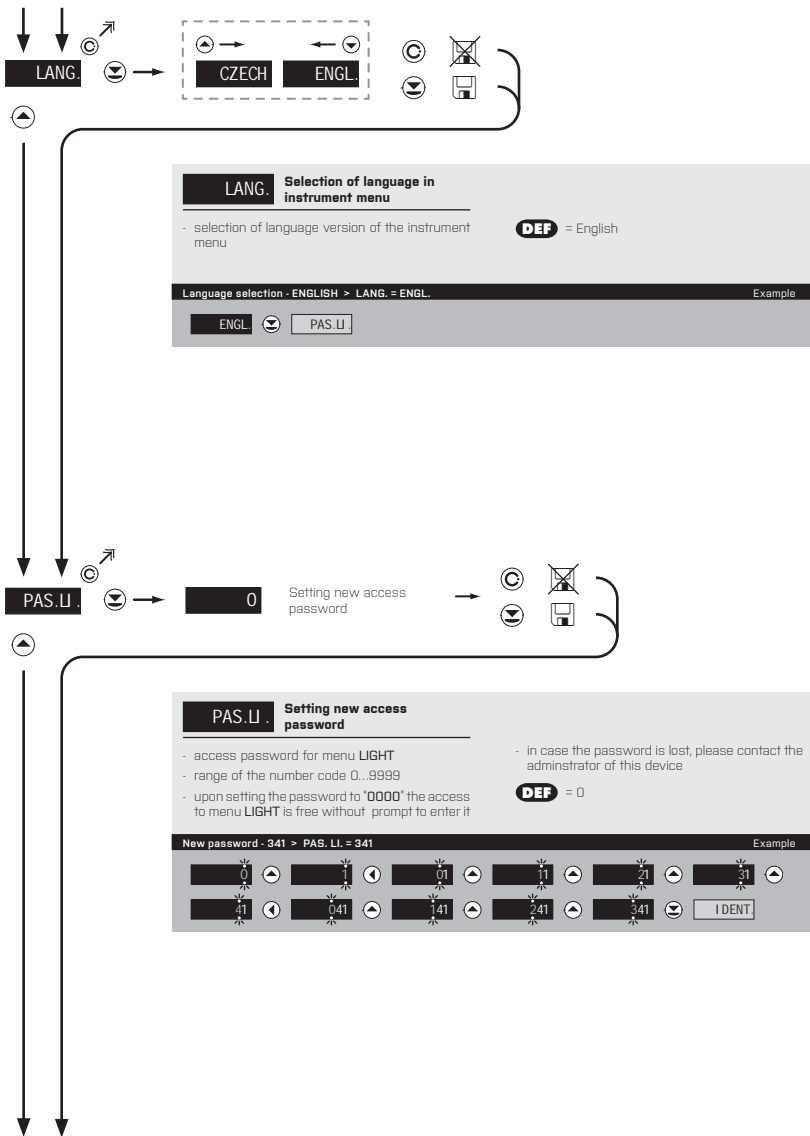

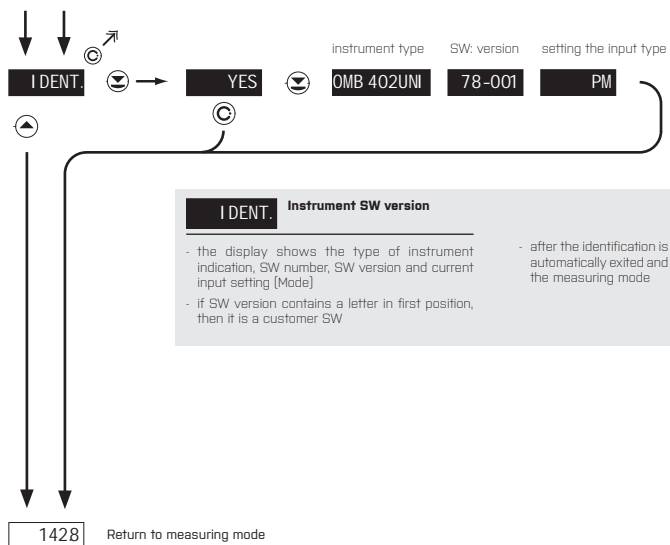



SETTING **PROFI**

For expert users

Complete instrument menu

Access is password protected

Possibility to arrange items of the **USER MENU**

Tree menu structure

6.0 SETTING "PROFI"

PROFI

Complete programming menu

- contains complete instrument menu and is protected by optional number code
- designed for expert users
- preset from manufacture is menu **LIGHT**

Switching over to "PROFI" menu



- access to **PROFI** menu
- authorization for access to **PROFI** menu does not depend on setting under item **SERVIC. > MENU**
- password protected access (unless set as follows under the item **SERVIC. > N. PASS. > PROFI =0**)



- access to menu selected under item **SERVIC. > MENU > LIGHT/PROFI**
- password protected access (unless set as follows under the item **SERVIC. > N. PASS. > LIGHT =0**)
- for access to **LIGHT** menu passwords for **LIGHT** and **PROFI** menu may be used



6. SETTING PROFI

6.1 SETTING "PROFI" - INPUT

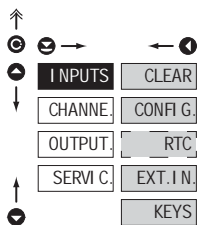

The primary instrument parameters are set in this menu

CLEAR	Resetting internal values
CONF G.	Selection of measuring range and parameters
RTC	Setting date and time for option with RTC
EXT. I N.	Setting external inputs functions
KEYS	Assigning further functions to keys on the instrument

6.1.1 RESETTING INTERNAL VALUES

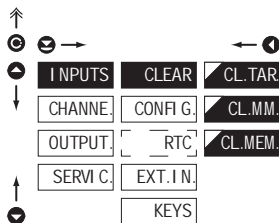

CLEAR	Resetting internal values
CL. TAR.	Tare resetting
CL. MM.	Resetting min/max value
CL. MEM.	Resetting the instrument memory

- resetting memory for the storage of minimum and maximum value achieved during measurement
- resetting memory with data measured in the "FAST" or "RTC" modes
- not in standard equipment

6.1.2a SELECTION OF MEASURING RATE

↑

⊖ ⊕ →

← ⊖

I INPUTS	CLEAR	READ./S	40.0
CHANNE.	CONF G.	TYPE	20.0
OUTPUT.	RTC	MODE	10.0
SERVIC.	EXT.I.N.	CONECT.	5.0
	KEYS	C.J.TEM.	2.0
		AD.RES.	1.0
		LEADS	05
			02
			01

DEF

↑

⊖

READ./S Selection of measuring rate

40.0	40,0 measurements/s
20.0	20,0 measurements/s
10.0	10,0 measurements/s
5.0	5,0 measurements/s
2.0	2,0 measurements/s
1.0	1,0 measurement/s
0.5	0,5 measurements/s
0.2	0,2 measurements/s
0.1	0,1 measurements/s

6.1.2b SELECTION OF „INSTRUMENT“ TYPE

↑

⊖ ⊕ →

← ⊖

I INPUTS	CLEAR	READ./S	DC
CHANNE.	CONF G.	TYPE	PM
OUTPUT.	RTC	MODE	OHM
SERVIC.	EXT.I.N.	CONECT.	RTD-Pt
	KEYS	C.J.TEM.	RTD-Ni
		AD.RES.	TC
		LEADS	DU
			RTD-Cu

DEF

↑

⊖

TYPE Selection of „instrument“ type

- selection of particular type of "instrument" is bound to relevant dynamic items

DC	DC voltmeter
PM	Process monitor
OHM	Ohmmeter
RTD-Pt	Thermometer for Pt xxxx
RTD-Ni	Thermometer for Ni xxxx
TC	Thermometer pro thermocouples
DU	Display for linear potentiometers
RTD-Cu	Thermometer for Cu xxx

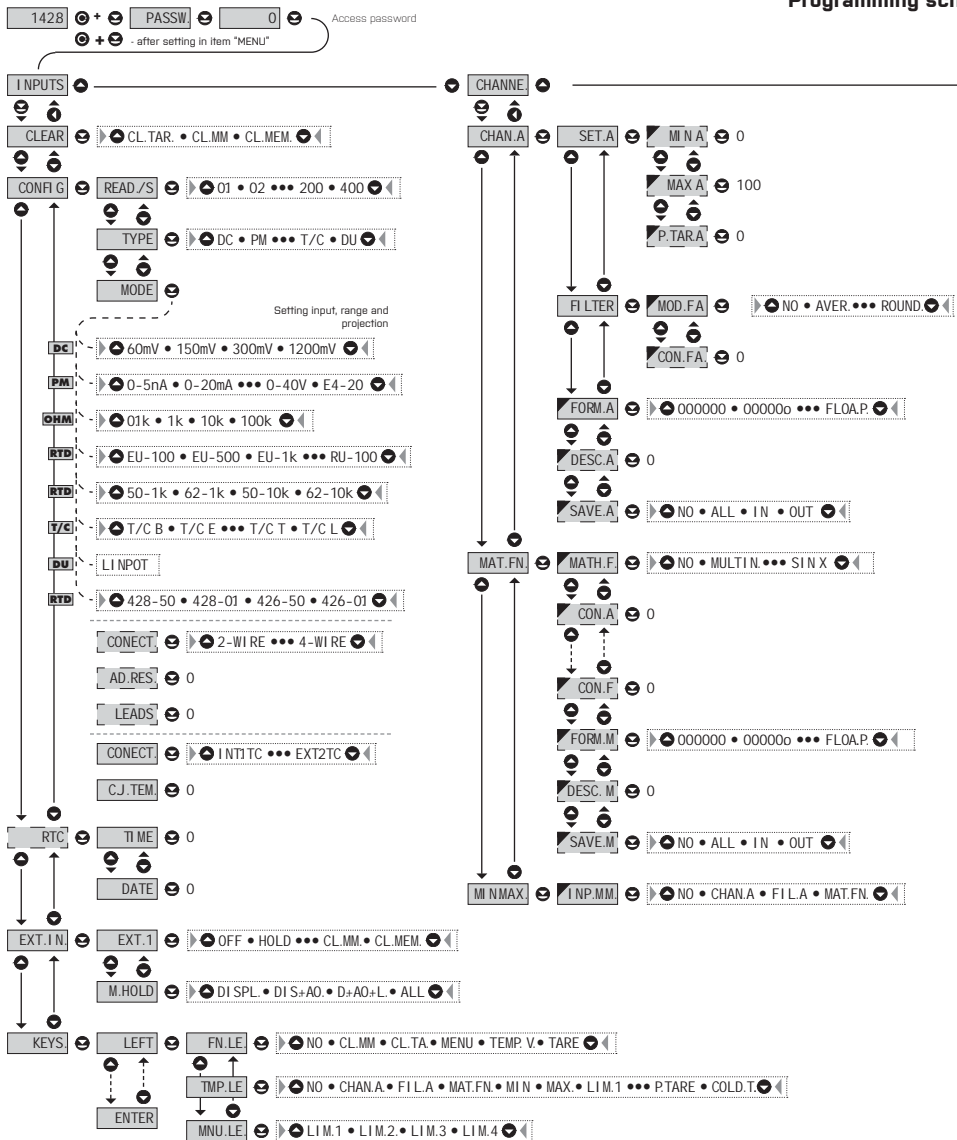

menu PROFI MENU

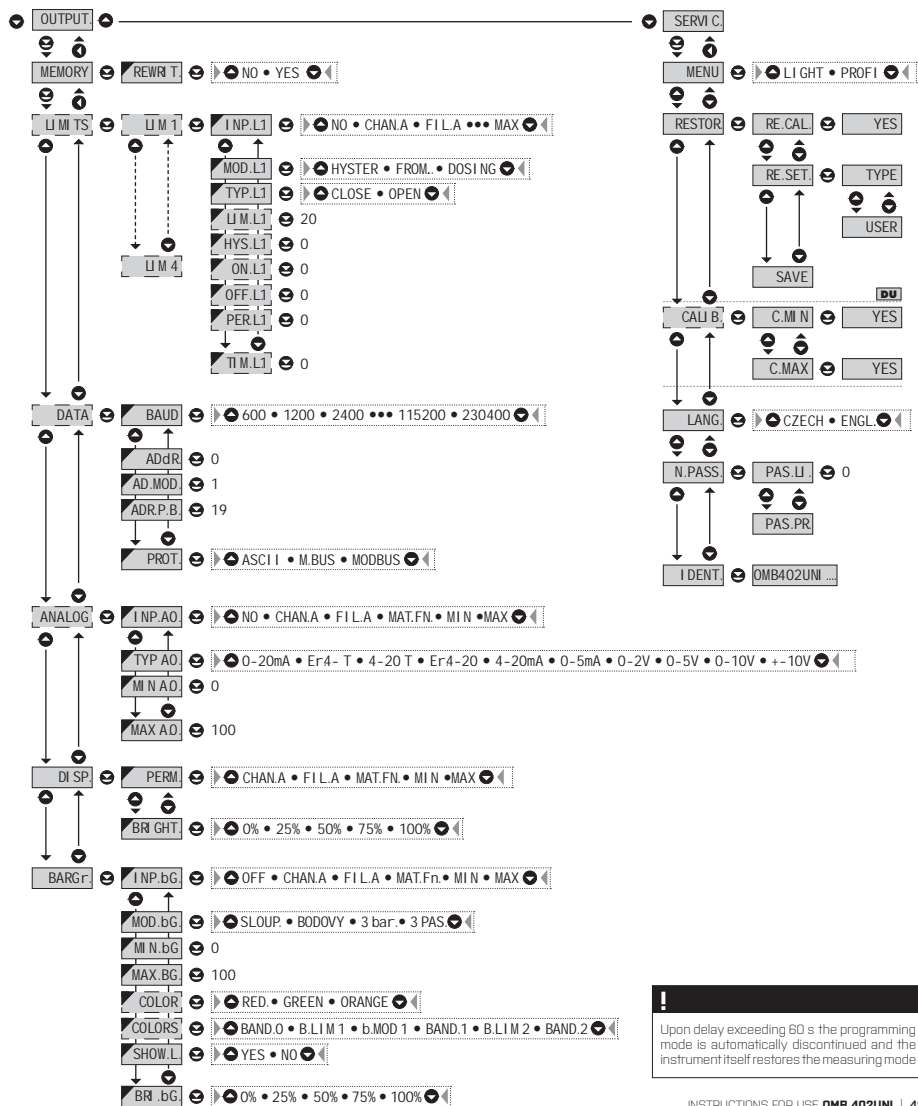

! Upon delay exceeding 60 s the programming mode is automatically discontinued and the instrument itself restores the measuring mode

6. SETTING PROFI



1.2c SELECTION OF MEASURING RANGE

CLEAR 60mV 100 R **DEF**
 CONF G. 150mV 1 k
 300mV 10 k
 EXT. I N. 1200mV 100 k
 C.J. TEM.

DC - A **PM**
 100 V 0-5mA **DEF**
 250 V 0-20mA **DEF**
 500 V 4-20mA **DEF**
 010 A 0-2 V
 0.25 A 0-5 V
 0.50 A 0-10 V
 1.00 A 0-40 V
 5.00 A Er4-20

RTD-Pt **RTD-Cu**
DEF EU-100 428-50 **DEF**
 EU-500 428-01
 EU-1k0 426-50
 US-100 426-01
 RU-50
 RU-100

T/C
 T/C B
 T/C E
DEF 50-1k T/C J **DEF**
 62-1k T/C K
 50-10k T/C N
 62-10k T/C R
 T/C S
 T/C T
DEF DU T/C L

DU LN POT.

MODE	Selection of instrument measuring range	
	Menu	Measuring range
DC	60 mV	±60 mV
	150 mV	±150 mV
	300 mV	±300 mV
	1200mV	±12 V
	100 V	±100 V
DC - A	250 V	±250 V
	500 V	±500 V
	0.10 A	±0.1 A
	0.25 A	±0.25 A
	0.50 A	±0.5 A
	1.00 A	±1 A
	5.00 A	±5 A
PM	0.5mA	0...5 mA
	0.20mA	0...20 mA
	4.20mA	4...20 mA
	0.2 V	±2 V
	0.5 V	±5 V
	0.10 V	±10 V
	0.40 V	±40 V
	Er4.20	4...20 mA, with error statement of „underfl ow“ upon signal smaller than 3.36 mA
OHM	100 R	0...100 Ω
	1 k	0...1 kΩ
	10 k	0...10 kΩ
	100 k	0...100 kΩ
	RTD-PT	EU-100
EU-500		Pt 500 [3 850 ppm/°C]
EU-1k0		Pt 1000 [3 850 ppm/°C]
US-100		Pt 100 [3 920 ppm/°C]
RU-50		Pt 50 [3 910 ppm/°C]
RU-100	Pt 100 [3 910 ppm/°C]	
RTD-NI	5.0-1k	Ni 1 000 [5 000 ppm/°C]
	6.2-1k	Ni 1 000 [6 180 ppm/°C]
	5.0-10k	Ni 10 000 [5 000 ppm/°C]
	6.2-10k	Ni 10 000 [6 180 ppm/°C]
RTD-CU	428-50	Cu 50 [4 260 ppm/°C]
	428-01	Cu 1 00 [4 280 ppm/°C]
	426-50	Cu 50 [4 260 ppm/°C]
	426-01	Cu 100 [4 260 ppm/°C]
T/C	T/C B	B
	T/C E	E
	T/C J	J
	T/C K	K
	T/C N	N
	T/C R	R
	T/C S	S
	T/C T	T
	T/C L	L

6.1.2d SELECTION OF TYPE OF SENSOR CONNECTION

RTD OHM T/C

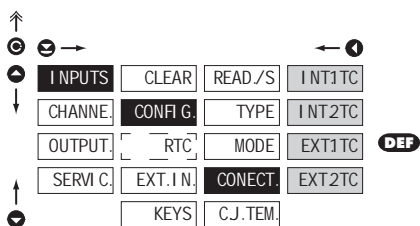
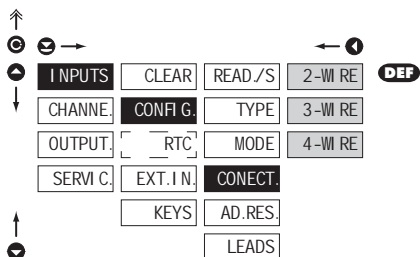
**CONNECT.** Selection of type of sensor connection**RTD OHM**

- 2-W RE** 2-wire connection
- 3-W RE** 3-wire connection
- 4-W RE** 4-wire connection

T/C

- INT1TC** Measurement without reference thermocouple
 - measuring cold junction at instrument brackets
- INT2TC** Measurement with reference thermocouple
 - measuring cold junction at instrument brackets with anti-series connected reference thermocouple
- EXT1TC** Measurement without reference thermocouple
 - the entire measuring set is working under invaried and constant temperature
- EXT2TC** Measurement with reference thermocouple
 - when using compensation box

!

Method and procedure of setting the cold junctions is described in separate chapter on page 86

!

For thermocouple type 'B' the items **CONECT.** and **C.J. TEM.** are not available

6. SETTING PROFI

6.1.2e SETTING TEMPERATURE OF COLD JUNCTION

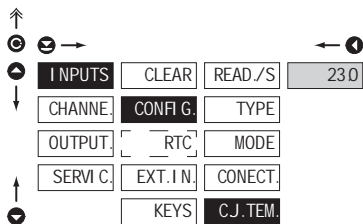
T/C

C.J. TEM. Setting temperature of cold junction

- range 0...99°C with compensation box

DEF = 23°C

6.1.2f ZERO OFFSET OF THE MEASUREMENT RANGE

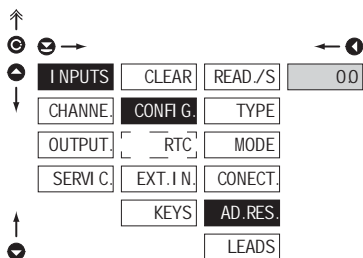
RTD OHM

AD.RES. Offset of the beginning of the measuring range

- in cases when it is necessary to offset the beginning of the range by certain value, e.g. while using sensor in measuring head

- entered directly in Dhmm [0...9999]

DEF = 0

6.1.2g COMPENSATION OF 2-WIRE CONDUCT

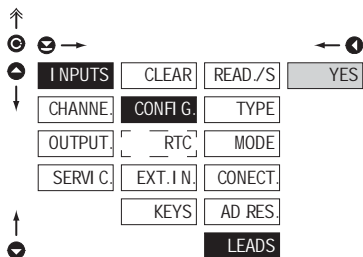
RTD OHM

LEADS Compensation of 2-wire conduct

- for measurement accuracy it is necessary to perform compensation of conduct always in case of 2-wire connection

- prior confirmation of the displayed prompt "YES" it is necessary to substitute the sensor at the end of the conduct by a short-circuit

DEF = 0

6.1.3 SETTING THE REAL TIME CLOCK

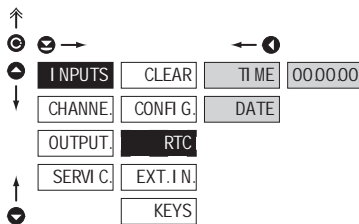

RTC Setting the real time clock (RTC)

TIME Time setting

- format 23.59.59

DATE Date setting

- format DD.MM.YY

6.1.4a EXTERNAL INPUT FUNCTION SELECTION

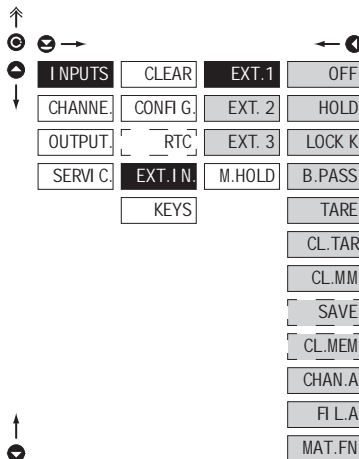

EXT. I.N. External input function selection

OFF Input is off

HOLD Activation of HOLD

LOCK K. Locking keys on the instrument

B.PASS. Activation of locking access into programming menu

LIGHT/PROFI

TARE Tare activation

CL. TAR Tare resetting

CL.MM. Resetting min/max value

SAVE Activation of measured data record in instrument memory

CL.MEM. Clearing memory for option FAST/RTC

CHAN.A Displaying value of "Channel A"

FI L.A Displaying value of "Channel A" after being processed by digital filters

MAT.FN. Displaying value of "Mathematical function"

- DEF EXT. 1 > HOLD

- DEF EXT. 2 > LOCK K.

- DEF EXT. 3 > TARE

*

Procedure identical for EXT. 2 and EXT. 3

6. SETTING PROFI

6.1.4b SELECTION OF FUNCTION "HOLD"

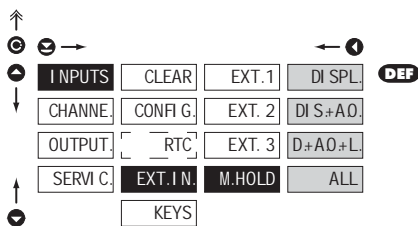

M.HOLD Selection of function "HOLD"

DI SPL.	"HOLD" locks only the value displayed
DI S+AO.	"HOLD" locks the value displayed and on AO
D+AO+L.	"HOLD" locks the value displayed, on AO and limit evaluation
ALL	"HOLD" locks the entire instrument

6.1.5a OPTIONAL ACCESSORY FUNCTIONS OF THE KEYS

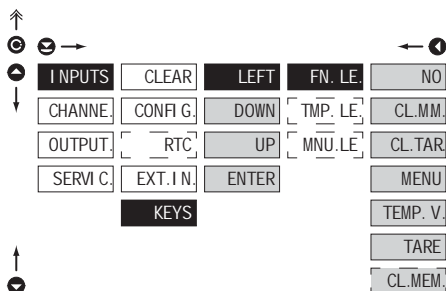

FN. LE. Assigning further functions to instrument keys

- „FN. LE.“ > executive functions

NO	Key has no further function
CL.MM.	Resetting min/max value
CL.TAR.	Tare resetting
MENU	Direct access into menu on selected item
TEMP. V.	Temporary projection of selected values
TARE	Tare function activation
CL.MEM.	Clearing memory

- after confirmation of this selection the "MNU. LE." item is displayed on superior menu level, where required selection is performed

- after confirmation of this selection the "TMP. LE." is displayed on superior menu level, where required selection is performed

- clearing memory with data measured in modes "FAST" or "RTC"

Setting is identical for LEFT, DOWN, UP and ENTER

! Preset values of the control keys DEF

LEFT	Show Tare
UP	Show Max. value
DOWN	Show Min. value
ENTER	w/o function

6.1.5b

OPTIONAL ACCESSORY FUNCTIONS OF THE KEYS - TEMPORARY PROJECTION

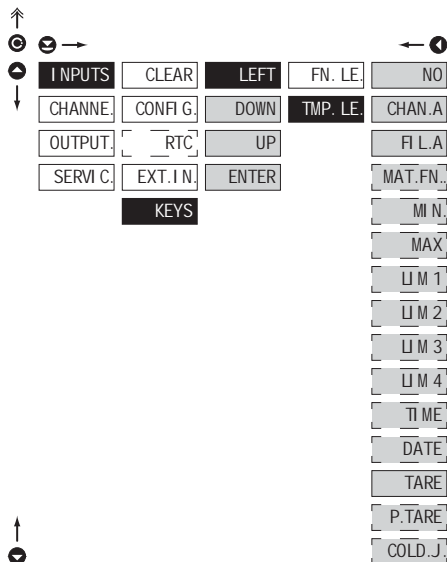
**TMP. LE.** Temporary projection of selected item

- „TMP. LE.“ > temporary projection of selected values
- "Temporary" projection of selected value is displayed for the time of keystroke
- "Temporary" projection may be switched to permanent by pressing **C** + "Selected key", this holds until the stroke of any key

NO	Temporary projection is off
CHAN. A	Temporary projection of "Channel A" value
FI. LA	Temporary projection of "Channel A" value after processing digital filters
MAT. FN.	Temporary projection of "Mathematic functions" value
MIN	Temporary projection of "Min. value"
MAX	Temporary projection of "Max. value"
LIM 1	Temporary projection of "Limit 1" value
LIM 2	Temporary projection of "Limit 2" value
LIM 3	Temporary projection of "Limit 3" value
LIM 4	Temporary projection of "Limit 4" value
TIME	Temporary projection of "TIME" value
DATE	Temporary projection of "DATE" value
TARE	Temporary projection of "TARE" value
P. TARE	Temporary projection of "P. TARE" value
COLD. J.	Temporary projection of "CJC" value

!
Setting is identical for LEFT, DOWN, UP and ENTER

6. SETTING PROFI

6.1.5c

OPTIONAL ACCESSORY FUNCTIONS OF THE KEYS - DIRECT ACCESS TO ITEM

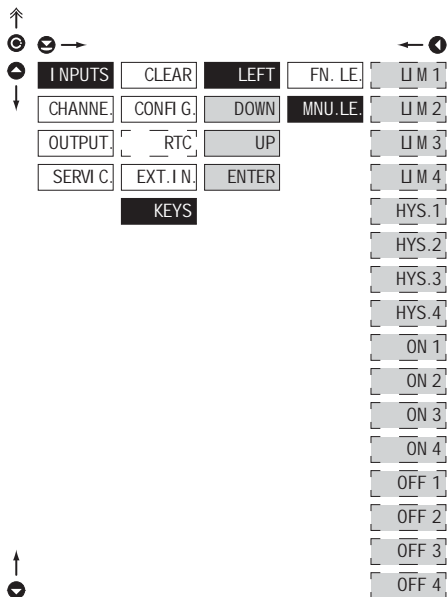

MNU. LE. Assigning access to selected menu item

LM 1	Direct access to item "LM 1"
LM 2	Direct access to item "LM 2"
LM 3	Direct access to item "LM 3"
LM 4	Direct access to item "LM 4"
HYS. 1	Direct access to item "HYS. 1"
HYS. 2	Direct access to item "HYS. 2"
HYS. 3	Direct access to item "HYS. 3"
HYS. 4	Direct access to item "HYS. 4"
ON 1	Direct access to item "ON 1"
ON 2	Direct access to item "ON 2"
ON 3	Direct access to item "ON 3"
ON 4	Direct access to item "ON 4"
OFF 1	Direct access to item "OFF 1"
OFF 2	Direct access to item "OFF 2"
OFF 3	Direct access to item "OFF 3"
OFF 4	Direct access to item "OFF 4"

Setting is identical for LEFT, DOWN, UP and ENTER



6. SETTING PROFI

6.2 SETTING "PROFI" - CHANNELS

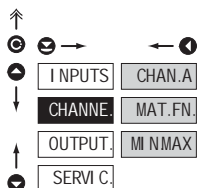

The primary instrument parameters are set in this menu

CHAN. A	Setting parameters of measuring "Channel A"
MAT. FN.	Setting parameters of mathematic functions
MI NMAX	Selection of access and evaluation of Min/max value

6.2.1a DISPLAY PROJECTION

DC PM DU OHM

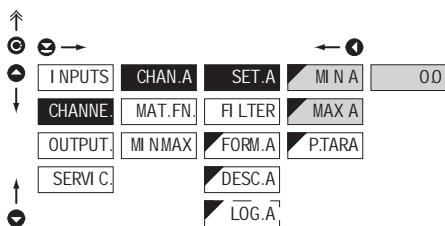

SET. A Setting display projection

MI N A	Setting display projection for minimum value of input signal
	- range of the setting: .99999...999999
	- DEF = 0.0
MAX A	Setting display projection for maximum value of input signal
	- range of the setting: .99999...999999
	- DEF = 100.0

6.2.1b SETTING FIXED TARE

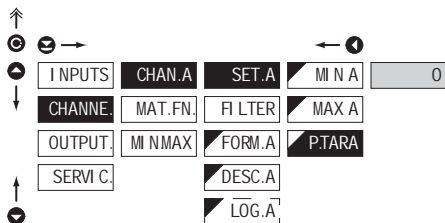

P. TARA Setting "Fixed tare" value

- setting is designed for the event when it is necessary to firmly shift the beginning of the range by known size
- when setting [P. TAR. A≠ 0] is in effect, display does not show the "T" symbol
- range of the setting: .99999...999999
- **DEF** = 0

6. SETTING PROFI

6.2.1e PROJECTION FORMAT - POSITIONING OF DECIMAL POINT

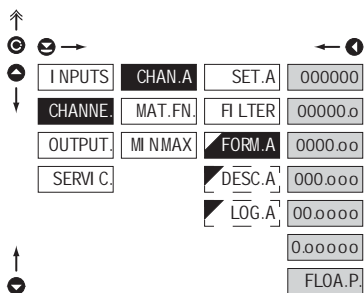

FORM.A Selection of decimal point

- the instrument allows for classic projection of a number with positioning of the DP as well as projection with floating DP, allowing to display a number in its most exact form „FLOAT.P.“

000000. Setting DP - XXXXX.

00000.o Setting DP - XXXXX.x

DEF > **RTD** **T/C**

0000.o0 Setting DP - XXXX.xx

DEF > **DC** **PM** **DU** **OHM**

000.o00 Setting DP - XXX.xxx

00.o000 Setting DP - XX.xxxx

0.o0000 Setting DP - X.xxxxx

FLOA.P. Floating DP

6.2.1f PROJECTION OF DESCRIPTION - THE MEASURING UNITS

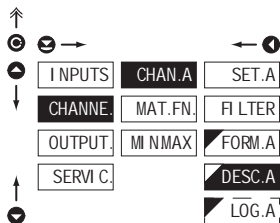

DESC.A Setting projection of descritp. for "Channel A"

- projection of measured data may be extended (at the expense of the number of displayed places) by two characters for description
- description is set by shifted ASCII code, when two first places show the set description and two last characters their code in period 0...95
- description is cancelled by code 00

RTD **T/C** **DEF** = °C

DC **PM** **DU** **OHM** **DEF** = none

! Table of signs on page 91

6.2.1g

SELECTION OF STORING DATA INTO INSTRUMENT MEMORY

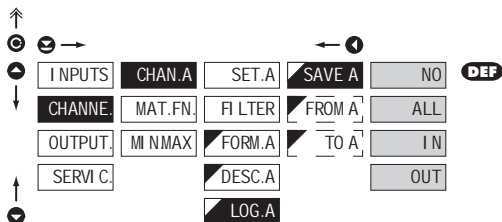

LOG. A

Selection of storing data into instrument memory

- by selection in this item you allow to register values into instrument memory
- another setting in item "OUTPUT. > MEMORY" (not in standard experiment)

NO

Measured data is not stored

ALL

Measured data is stored in memory

I N

Only data measured within the set interval is stored in memory

OUT

Only data measured outside the set interval is stored in memory

FROM A

Setting the initial interval value

- setting range: -99999...999999

TO A

Setting the final interval value

- setting range: -99999...999999

6. SETTING PROFI

6.2.2a

MATHEMATIC FUNCTIONS

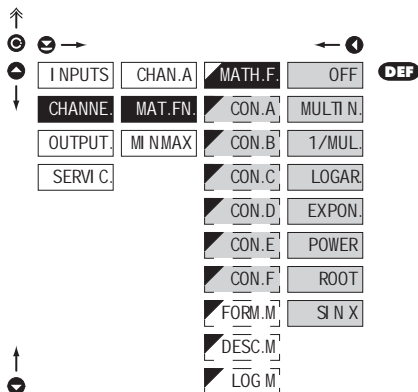

MATH.F. Selection of mathematic functions

OFF Mathematic functions are off

MULTI.N. Multinomial

$$Ax^5 + Bx^4 + Cx^3 + Dx^2 + Ex + F$$

1/MUL. $1/x$

$$\frac{A}{x^5} + \frac{B}{x^4} + \frac{C}{x^3} + \frac{D}{x^2} + \frac{E}{x} + F$$

LOGAR. Logarithm

$$A \times \ln\left(\frac{Bx+C}{Dx+E}\right) + F$$

EXPON. Exponential

$$A \times e^{\left(\frac{Bx+C}{Dx+E}\right)} + F$$

POWER Power

$$A \times (Bx+C)^{(Dx+E)} + F$$

ROOT Root

$$A \times \sqrt{\frac{Bx+C}{Dx+E}} + F$$

SIN X Sin x

$$A \sin^5 x + B \sin^4 x + C \sin^3 x + D \sin^2 x + E \sin x + F$$

CON.- Setting constants for calculation of mat.functions

- this menu is displayed only after selection of given mathematic function



6. SETTING PROFI

6.3 SETTING „PROFI“ - OUTPUTS

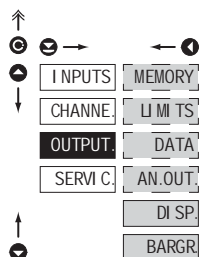

In this menu it is possible to set parameters of the instrument output signals

MEMORY	Setting data logging into memory
LI MI TS	Setting type and parameters of limits
DATA	Setting type and parameters of data output
AN. OUT.	Setting type and parameters of analog output
DI SP.	Setting display projection and brightness
BARGR.	Setting bargraph projection and brightness

6.3.1a SELECTION OF MODE OF DATA LOGGING INTO INSTRUMENT MEMORY

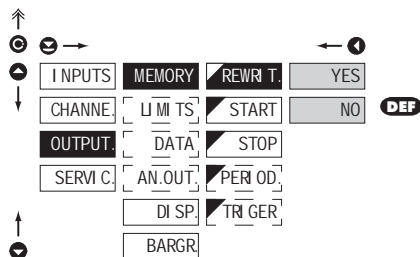

REWRIT. Selection of the mode of data logging

- selection of the mode in the event of full instrument memory

NO	Rewriting values prohibited
YES	Rewriting values permitted, the oldest get rewritten by the latest

6.3.1b SETTING DATA LOGGING INTO INSTRUMENT MEMORY - RTC

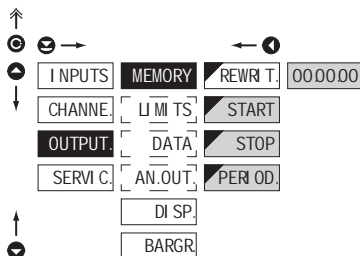

RTC

The lowest recording rate possible is once a day, the highest is every second. Under exceptional circumstances it is possible to set the rate to 8 times per second by entering the recording period as 00:00:00. However, this mode is not recommended due to the memory overload. Recordings are realised in a timeframe of one day and are repeated periodically every following day. Recordings can take place either inside or outside of selected time intervals. The duration of re-writing can be determined by the number of channels recorded as well as by the recording rate.

START

Start of data logging into instrument memory

- time format HH.MM.SS

STOP

Stop data logging into instrument memory

- time format HH.MM.SS

PER OD.

Period of data logging into instrument memory

- determines the period in which values will be logged in an interval delimited by the time set under items **START** and **STOP**
- time format HH.MM.SS
- records are made on a daily basis in selected interval and period
- item not displayed if "SAVE" is selected in menu (INPUT > EXT. IN.)

6.3.1c SETTING DATA LOGGING INTO INSTRUMENT MEMORY - FAST

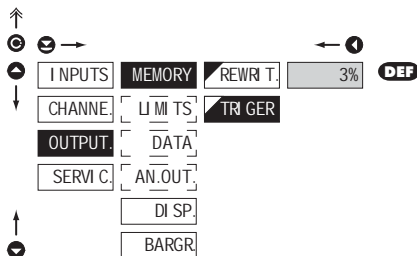

FAST

The memory operates on the basis of memory oscilloscope. Select an area of 0...100% of the memory capacity. [100% represents 8 192 individual recordings for a single channel measurement]. This area is filled cyclically up to the point when the recording starts (activated by the front panel button or by an external input). When the remaining memory capacity fills up the recording stops. A new recording is possible after the deletion of the latest recording. It is possible to abort a recording before its completion by reading out the data.

TRIG GER

Setting logging data into inst. memory

- logging data into inst. memory is governed by the following selection, which determines how many percent of the memory is reserved for data logging prior to initiation of trigger impulse
- initialization is on ext. input or button
- setting in range 1...100 %
- when setting 100 %, datalogging works in the mode **ROLL** > data keep getting rewritten in cycles

1. Memory initialization

- clear memory (ext.input, button)
- LED "M" flashes, after reading **TRIGGER** [%] memory is permanently shining. In **ROLL** flashes constantly.

2. Triggering

- external input, button
- after the memory LED is full "M" turns off
- in the **ROLL** mode the trigger ends datalogging and LED turns off

3. Termination

- ext. input, button or reading data via RS

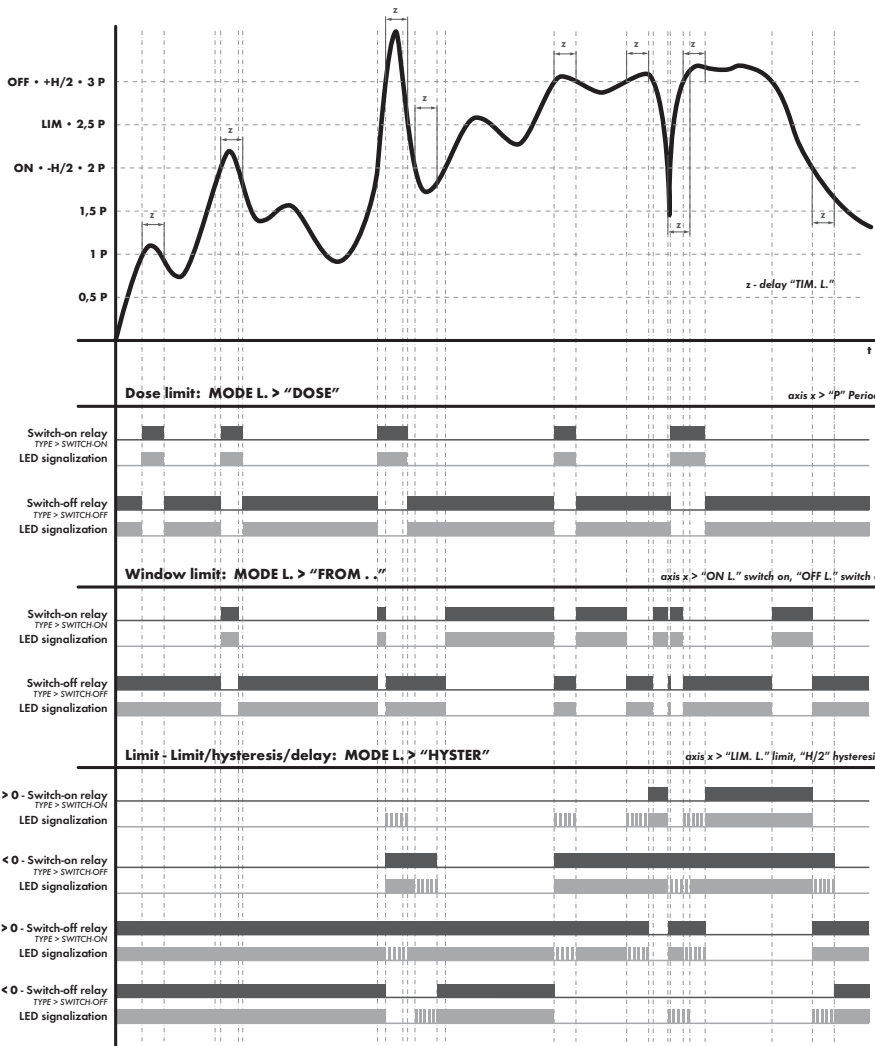

6.3.2a SELECTION OF INPUT FOR LIMITS EVALUATION

Navigation icons: ↑, Ⓒ, →, ←, Ⓔ, ↓, Ⓕ, Ⓓ, Ⓔ

I N P U T S	MEMORY	LIM 1	I N P . L 1	NO
CHANNE.	LIM TS	LIM 2	MOD. L1	CHAN. A
OUTPUT.	DATA	LIM 3	TYP. L1	FI. LA
SERVIC.	AN. OUT.	LIM 4	LIM. L1	MAT. FN.
	DI SP.		HYS. L1	MI N
	BARGR		ON L1	MAX
			OFF. L1	
			PER. L1	
			TIM. L1	

DEF

I N P . L 1 Selection evaluation of limits

- selection of value from which the limit will be evaluated

NO	Limit evaluation is off
CHAN. A	Limit evaluation from "Channel A"
FI. LA	Limit evaluation from "Channel A" after digital filters processing
MAT. FN.	Limit evaluation from "Mathematic functions"
MI N	Limit evaluation from "Min. value"
MAX	Limit evaluation from "Max. value"

! Setting is identical for LIM 1, LIM 2, LIM 3 and LIM 4

6.3.2b SELECTION OF TYPE OF LIMIT

Navigation icons: ↑, Ⓒ, →, ←, Ⓔ, ↓, Ⓕ, Ⓓ, Ⓔ

I N P U T S	MEMORY	LIM 1	I N P . L 1	HYSTER
CHANNE.	LIM TS	LIM 2	MOD. L1	FROM..
OUTPUT.	DATA	LIM 3	TYP. L1	DOSI NG
SERVIC.	AN. OUT.	LIM 4	LIM. L1	
	DI SP.		HYS. L1	
	BARGR		ON L1	
			OFF. L1	
			PER. L1	
			TIM. L1	

DEF

MOD. L1 Selection the type of limit

- | | |
|--------|---------------------------------------------|
| HYSTER | Limit is in mode "Limit, hysteresis, delay" |
|--------|---------------------------------------------|
- for this mode the parameters of "LIM. L1" are set, at which the limit will shall react, "HYS. L1" the hysteresis range around the limit [$LIM \pm 1/2 HYS$] and time "TIM. L1" determining the delay of relay switch-on
- | | |
|--------|-------------|
| FROM.. | Frame limit |
|--------|-------------|
- for this mode the parameters are set for interval "ON. L1" the relay switch-on and "OFF. L1" the relay switch-off
- | | |
|---------|-----------------------|
| DOSI NG | Dose limit (periodic) |
|---------|-----------------------|
- for this mode the parameters are set for "PER. L1" determining the limit value as well as its multiples at which the output is active and "TIM. L2" indicating the time during which is the output active

! Setting is identical for LIM 1, LIM 2, LIM 3 and LIM 4

6. SETTING PROFI

6.3.2c SELECTION OF TYPE OF OUTPUT

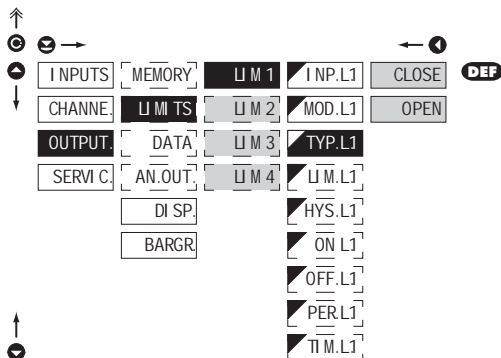

TYP.L1 Selection of type of output

CLOSE Output switches on when condition is met

OPEN Output switches off when condition is met

Setting is identical for LIM 1, LIM 2, LIM 3 and LIM 4

6.3.2d SETTING VALUES FOR LIMITS EVALUATION

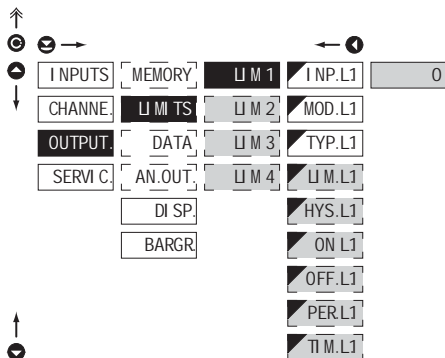

LIM.L1 Setting limit for switch-on

- for type 'HYSTER'

HYS.L1 Setting hysteresis

- for type 'HYSTER'
- indicates the range around the limit (in both directions, LIM. \pm 1/2 HYS.)

ON.L1 Setting the outset of the interval of limit switch-on

- for type 'FROM..'

OFF.L1 Setting the end of the interval of limit switch-on

- for type 'FROM..'

PER.L1 Setting the period of limit switch-on

- for type 'DOSING'

TIM.L1 Setting the time switch-on of the limit

- for type 'HYSTER' and 'DOSING'
- setting within the range: $\pm 0..99.9$ s
- positive time > relay switches on after crossing the limit (LIM. L1) and the set time (TIM. L1)
- negative time > relay switches off after crossing the limit (LIM. L1) and the set negative time (TIM. L1)

Setting is identical for LIM 1, LIM 2, LIM 3 and LIM 4

6.3.3a SELECTION OF DATA OUTPUT BAUD RATE

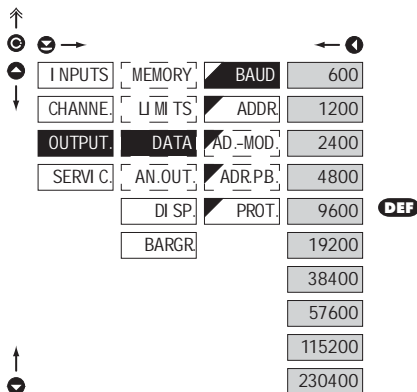
**BAUD** Selection of data output baud rate

600	Rate - 600 Baud
1200	Rate - 1200 Baud
2400	Rate - 2 400 Baud
4800	Rate - 4 800 Baud
9600	Rate - 9 600 Baud
19200	Rate - 19 200 Baud
38400	Rate - 38 400 Baud
57600	Rate - 57 600 Baud
115200	Rate - 115 200 Baud
230400	Rate - 230 400 Baud

6.3.3b SETTING INSTRUMENT ADDRESS

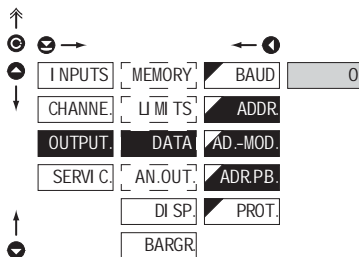
**ADDR** Setting instrument address

- setting in range 0...31
- **DEF** = 00

AD.-MOD. Setting instrument address - MODBUS

- setting in range 1...247
- **DEF** = 1

ADR.PB. Setting instrument address - PROFIBUS

- setting in range 1...127
- **DEF** = 19

6. SETTING PROFI

6.3.3c SELECTION OF DATA OUTPUT PROTOCOL

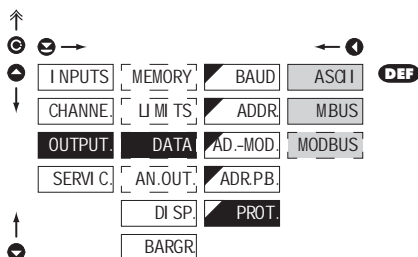

PROT. Selection of the type of analog output

ASQI Data protocol
ASCII

M.BUS Data protocol
DIN MessBus

MODBUS Data protocol
MODBUS-RTU

- option is available only for RS 485

6.3.4a SELECTION OF INPUT FOR ANALOG OUTPUT

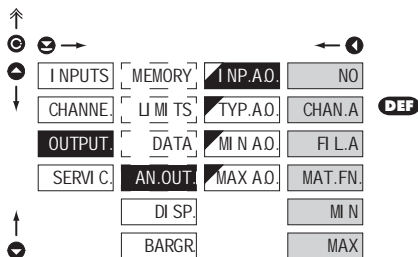

INP.AO. Selection evaluation analog output

- selection of value from which the analog output will be evaluated

NO AD evaluation is off

CHAN.A AD evaluation from
"Channel A"

FI L.A AD evaluation from
"Channel A" after digital
filters processing

MAT.FN. AD evaluation from
"Math. functions"

MI N AD evaluation from
"Min. value"

MAX AD evaluation from
"Max. value"

6.3.4b SELECTION OF THE TYPE OF ANALOG OUTPUT

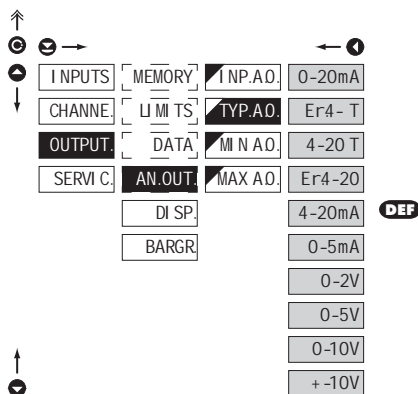

TYP. A.O. Selection of the type of analog output

0-20mA Type - 0...20 mA

Er4-T Type: 4...20 mA with indication

- with broken loop detection and indication of error statement (< 3.6 mA)

4-20 T Type: 4...20 mA with indication

- with broken loop detection (< 3.6 mA)

Er4-20 Type: 4...20 mA with indication

- with indic. of error statement (< 3.6 mA)

4-20mA Type - 4...20 mA

0-5mA Type - 0...5 mA

0-2V Type - 0...2 V

0-5V Type - 0...5 V

0-10V Type - 0...10 V

+ -10V Type - \pm 10 V

6.3.4c SETTING THE ANALOG OUTPUT RANGE

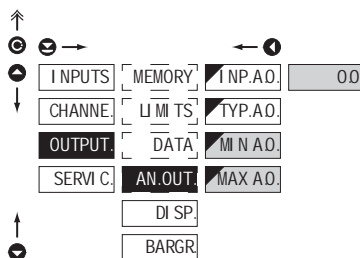

AN.OUT. Setting the analog output range

- analog output is isolated and its value corresponds with displayed data. It is fully programmable, i.e. it allows to assign the AO limit points to two arbitrary points of the entire measuring range

M I N A.O. Assigning the display value to the beginning of the AO range

- range of the setting: -99999...999999

- **DEF** = 0

MAX.A.O. Assigning the display value to the end of the AO range

- range of the setting: -99999...999999

- **DEF** = 100

6. SETTING PROFI

6.3.5a SELECTION OF INPUT FOR DISPLAY PROJECTION

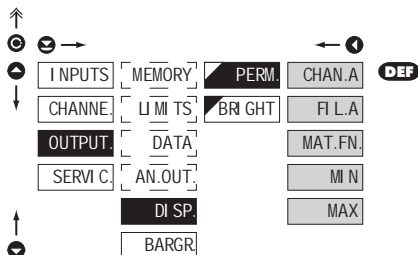

PERM. Selection display projection

- selection of value which will be shown on the instrument display

CHAN.A	Projection of values from "Channel A"
FI L.A	Projection of values from "Channel A" after digital filters processing
MAT.FN.	Projection of values from "Math. functions"
MI N	Projection of values from "Min. value"
MAX	Projection of values from "Max. value"

6.3.5b SELECTION OF DISPLAY BRIGHTNESS

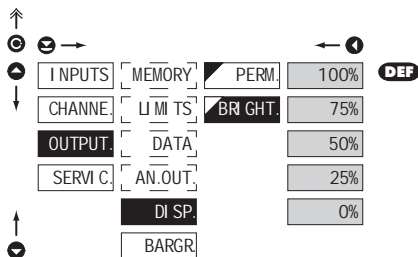

BR GHT Selection of display brightness

- by selecting display brightness we may appropriately react to light conditions in place of instrument location

0%	Display is off
25%	Display brightness - 25%
50%	Display brightness - 50%
75%	Display brightness - 75%
100%	Display brightness - 100%

6.3.6a BARGRAPH - SELECTION OF PROJECTION INPUT

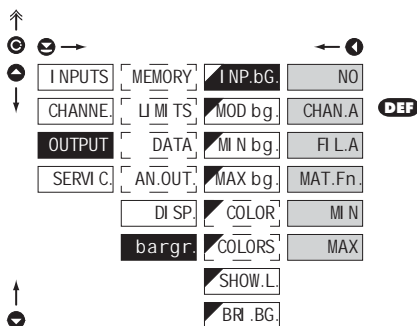

I NP.BG. Selection of bargraph evaluation

- selection of value from which the analog output will be evaluated

NO	Analog evaluation is off
CHAN.A	From "Channel A"
FI L.A	From "Channel A" after digital filter modification
MAT.Fn.	From "Mathematic function"
MI N	From "Minimum value"
MAX	From "Maximum value"

6.3.6b BARGRAPH - SELECTION OF PROJECTION MODE

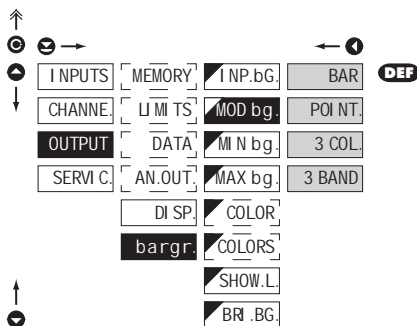

MOD.BG. Selection of bargraph projection mode

BAR	Column projection
POI NT.	Point projection
3 COL.	3-colored column projection
3 BAND	3-colored bar projection, cascade

- the display shows only a column in one color
- the display shows one point in one color
- change of color is determined by set limits [COLORS > BAND]
- upon exceeding the limit the color of the entire display, i.e. there is always only one column of one color lit
- change of color is determined by the said limits [COLORS > BAND]
- upon exceeding a limit color of the given display section is changing, i.e. the display may shine up to three colors at a time

6. SETTING PROFI

6.3.6c BARGRAPH - SETTING THE PROJECTION RANGE

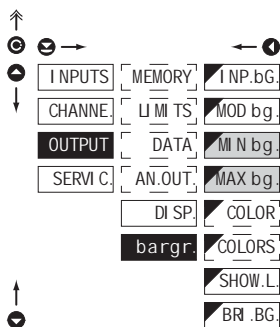

BARGR. Setting the bargraph projection range

- setting is the same as the setting for main display projection

MI N BG. Setting bargraph projection for minimum input signal value

- range of the setting is -99999...999999

- **DEF** = 0

MAX BG. Setting bargraph projection for maximum input signal value

- range of the setting is -99999...999999

- **DEF** = 100

6.3.6d BARGRAPH - SETTING COLOR

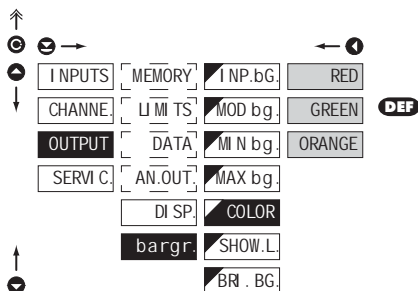

COLOR Selection of bargraph color

- the item "COLOR" is displayed only with selected mode ("BARGR. > MOD. BG.") "BAR." or "POINT."

RED Red color

GREEN Green color

ORANGE Orange color

6.3.6e BARGRAPH - COLOR SETTING

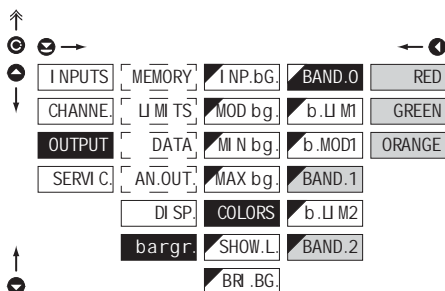
**BAND.0** Selection of bargraph color

- the item "COLORS" is displayed only with selected mode ("BARGR.>MOD.BG.") "3 COL." or "3 BAND"

RED	Red color
GREEN	Green color
ORANGE	Orange color

- **DEF** = Green (Band 0)
- **DEF** = Orange (Band 1)
- **DEF** = Red (Band 2)

! Setting is identical for **BAND.1** and **BAND.2**

6.3.6f BARGRAPH - SETTING THE COLOR CHANGES BANDS

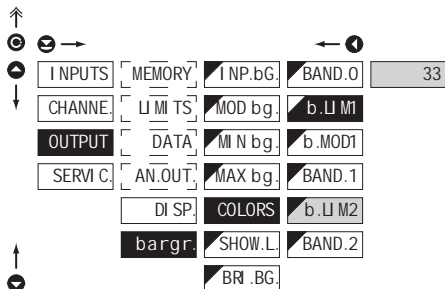
**b.LIM1** Setting color limits for color projection

- the item "COLORS" is displayed only with selected mode ("BARGR.>MOD.BG.") "3 COL." or "3 BAND."

- items „b.LIM 1“ and „b.LIM 2“ determine the borders of the bargraph color changes

b.LIM 1	Boundary between bands 0 - 1
b.LIM 2	Boundary between bands 1 - 2

- **DEF** = 33 [b.LIM 1]]
- **DEF** = 66 [b.LIM 2]

! Setting is identical for **B.LIM 2**

6. SETTING PROFI

6.3.6g BARGRAPH - SELECTION OF INVERSE PROJECTION

The screenshot shows a menu with the following items:

- ↑
- ⊙ ⊖ →
- ← ⊙
- DEF
- INPUTS MEMORY I NP.BG BAND.0 NORMAL
- CHANNE. U MI TS MOD bg. b.U M1 I NVERz
- OUTPUT DATA MI N bg. b.MOD1
- SERVIC. AN.OUT. MAX bg. BAND.1
- DI SP. COLORS b.U M2
- bargr. SHOW.L BAND.2
- BR .BG
- ↓

b.MOD 1 Selection of inverse projection of "Band 0"

- the item "COLORS" is displayed only with selected mode ["BARGR.>MOD.BG."] "3 COL." or "3 BAND."
- setting „b. MOD 1” is designed for projection where indication of zero center is required

NORMAL

Column in "BAND 0" moves from left to right

I NVERz.

Column in "BAND 0" moves from right to left

6.3.6h BARGRAPH - SELECTION OF LIMITS PROJECTION

The screenshot shows a menu with the following items:

- ↑
- ⊙ ⊖ →
- ← ⊙
- DEF
- INPUTS MEMORY I NP.BG YES
- CHANNE. U MI TS MOD bg. NO
- OUTPUT DATA MI N bg.
- SERVIC. AN.OUT. MAX bg.
- DI SP. COLOR
- bargr. COLORS
- SHOW.L.
- BR .BG
- ↓

SHOW.L. Selection of limit projection on the bargraph

- limits are always displayed orange, always by one degree lighter or darker

YES

Limits are projected

NO

Limity are not projected

6.3.6i BARGRAPH - SELECTION OF DISPLAY BRIGHTNESS

The screenshot shows a menu with the following items:

- ↑
- ⊙ ⊖ →
- ← ⊙
- DEF
- INPUTS MEMORY I NP.BG 100%
- CHANNE. U MI TS MOD bg. 75%
- OUTPUT DATA MI N bg. 50%
- SERVIC. AN.OUT. MAX bg. 25%
- DI SP. COLORS 0%
- bargr. SHOW.L.
- BR .BG
- ↓

BR .BG. Selection of bargraph brightness

0%

Bargraph is off

- after pres. the key the display lights up for 10s

25%

Brightness - 25%

50%

Brightness - 50%

75%

Brightness - 75%

100%

Brightness - 100%



6. SETTING PROFI

6.4 SETTING "PROFI" - SERVICE

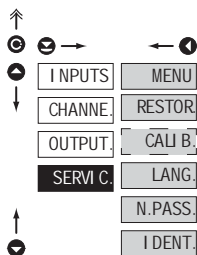

The instrument service functions are set in this menu

MENU	Selection of menu type LIGHT/PROFI
RESTOR.	Restore instrument manufacture setting and calibration
CALI B.	Input range calibration for „DU“ version
LANG.	Language version of instrument menu
N.PASS.	Setting new access password
I DENT.	Instrument identification

6.4.1 SELECTION OF TYPE OF PROGRAMMING MENU

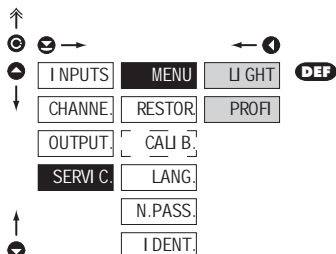

MENU Selection of menu type - LIGHT/PROFI

- enables setting the menu complexity according to user needs and skills

U GHT Active LIGHT menu

- simple programming menu, contains only items necessary for configuration and instrument setting
- linear menu > items one after another

PROFI Active PROFI menu

- complete programming menu for expert users
- tree menu



Change of setting is valid upon next access into menu

6.4.2 RESTORATION OF MANUFACTURE SETTING

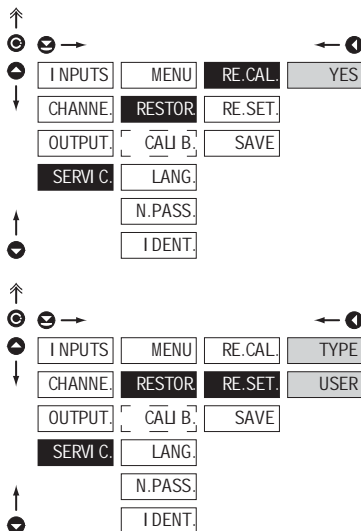
**RESTOR** Restoration of manufacture setting

- in the event of error setting or calibration, manufacture setting may be restored

RE.CAL. Restoration of manufacture calibration of the instrument

- prior executing the changes you will be asked to confirm you selection ,YES'

RE.SET. Restoration of instrument manufacture setting**TYPE** Restoration of instrument manufacture setting

- generating the manufacture setting for currently selected type of instrument (items marked DEF)

USER Restoration of instrument user setting

- generating the instrument user setting, i.e. setting stored under SERVI./RESTOR./SAVE

SAVE Save instrument user setting

- storing the user setting allows the operator to restore it in future if needed



After restoration the instrument switches off for couple seconds

JOBS PERFORMED**RESTORE**

JOBS PERFORMED	RESTORE	
	CALIBRATION	SETTING
cancel USER menu rights	✓	✓
deletes table of items order in USER - LIGHT menu	✓	✓
adds items from manufacture to LIGHT menu	✓	✓
deletes data stored in FLASH	✓	✓
cancel or linearization tables	✓	✓
clears tare	✓	✓
restore manufacture calibration	✓	✗
restore manufacture setting	✗	✓

6. SETTING PROFI

6.4.3 CALIBRATION - INPUT RANGE

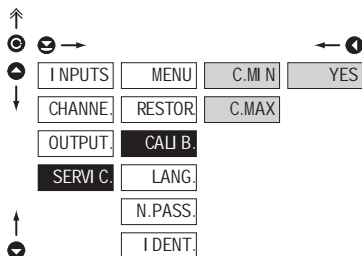
DU

CALI B. Input range calibration

- when "C. MIN" is displayed, move the potentiometer traveller to the required minimum position and confirm by „Enter“, calibration is confirmed by "YES"
- when "C. MAX" is displayed, move the potentiometer traveller to required maximum position and confirm by „Enter“, calibration is confirmed by "YES"

6.4.4 SELECTION OF INSTRUMENT MENU LANGUAGE VERSION

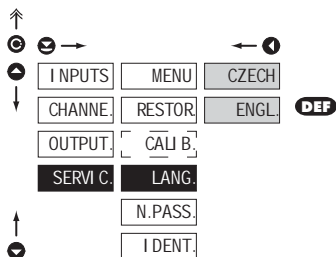

LANG. Selection of instrument menu language version

- CZECH** Instrument menu is in Czech
- ENGL.** Instrument menu is in English

6.4.5 SETTING NEW ACCESS PASSWORD

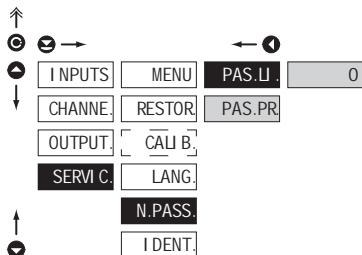

N. PASS. Setting new password for access to LIGHT and PROFi menu

- this option allows to change the numeric code, which blocks the access into LIGHT and PROFi menu.
- numerical code range: 0...9999
- universal passwords in the event of loss:
LIGHT Menu > „8177“
PROFI Menu > „7915“

6.4.6 INSTRUMENT IDENTIFICATION

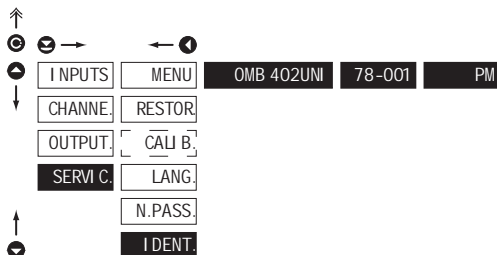
**I.DENT.** Projection of instrument SW version

- display shows type identification of the instrument, SW number, SW version and current input setting (Mode)
- if the SW version reads a letter on first position, it is a customer SW

	Pos.	Description
I.DENT.	1.	type of instrument
	2.	SW: number - version
	3.	the input type



SETTING USER

For user operation

Menu items are set by the user (Profi/Light) as per request

Access is not password protected

Optional menu structure either tree (PROFI) or linear (LIGHT)

7.0 SETTING ITEMS INTO "USER" MENU

- **USER** menu is designed for users who need to change only several items of the setting without the option to change the primary instrument setting (e.g. repeated change of limit setting)
- there are no items from manufacture permitted in **USER** menu
- on items indicated by inverse triangle  U M 1
- setting may be performed in **LIGHT** or **PROFI** menu, with the **USER** menu then overtaking the given menu structure

Setting

flashing legend - current setting is displayed



NO

item will not be displayed in USER menu

YES

item will be displayed in USER menu with editing option

SHOW

item will be solely displayed in USER menu

Setting sequence of items in "USER" menu

In compiling USER menu from active LIGHT menu the items (max. 10) may be assigned a sequence, in which they will be projected in the menu

setting projection sequence



Example of ranking the order of menu items in the "USER" menu

In this example we want to have a direct access to menu items Limit 1 and Limit 2 (example show is for the Light menu, but can equally be used in the Profi menu).

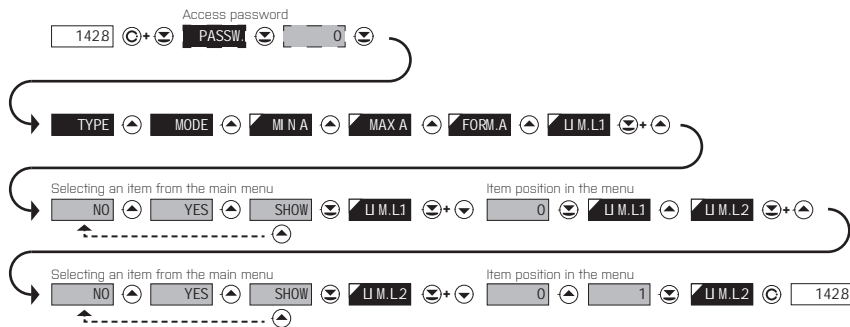

The result of this setting is that when the **⊙** button is pressed, the display will read „LIM L.1“. By pressing **⊙** button you confirm your selection and then you can set the desired limit value, or by pressing the **⬆** button you can go to setting of „LIM. L.2“ where you can proceed identically as with Limit one.

You can exit the setting by pressing the **⊙** button by which you store the latest setting and pressing the **⊙** button will take you back to the measuring mode

8. METHOD OF MEASURING THE CJC

Instrument with input for temperature measurement with thermocouple allows to set two types of measurement of cold junction.

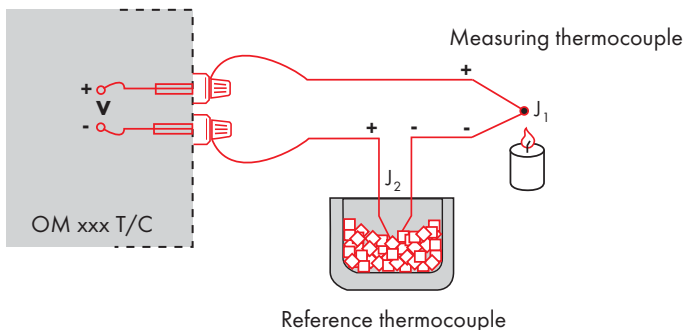

WITH REFERENCE THERMOCOUPLE

- a reference thermocouple may be located in the same place as the measuring instrument or in place with stable temperature/compensation box
- when measuring with reference thermocouple set **CONNECT** in the instrument menu to **INT2TC** or **EXT2TC**
- when using a thermostat (a compensation box or environment with constant temperature) set in the instrument menu **CJC.TEM**, its temperature (applies for setting **CONNECT** to **EXT2TC**)
- if the reference thermocouple is located in the same environment as the measuring instrument then set in the instrument menu **CONNECT** to **INT2TC**. Based on this selection the measurement of the ambient temperature is performed by a sensor located in the instrument terminal board

WITHOUT REFERENCE THERMOCOUPLE

- inaccuracy originating from the creation of dissimilar thermocouples on the transition point terminal/conductor of the thermocouple is not compensated for in the instrument
- when measuring without reference thermocouple set **CONNECT** in the instrument menu to **INT1TC** or **EXT1TC**
- when measuring temperature without reference thermocouple the error in measured data may be as much as 10°C (applies for setting **CONNECT** to **EXT1TC**)



9. DATA PROTOCOL



The instruments communicate via serial line RS232 or RS485. For communication they use the ASCII protocol. Communication runs in the following format:

ASCII: 8 bit, no parity, one stop bit

DIN MessBus: 7 bit, even parity, one stop bit

The transfer rate is adjustable in the instrument menu. The instrument address is set in the instrument menu in the range of 0 ÷ 31. The manufacture setting always presets the ASCII protocol, rate of 9600 Baud, address 00. The type of line used - RS232 / RS485 - is determined by an output board automatically identified by the instrument.

The commands are described in specifications you can find at www.orbit.merret.eu or software DM Link.

DETAILED DESCRIPTION OF COMMUNICATION VIA SERIAL LINE

EVENT	TYPE	PROTOCOL	TRANSMITTED DATA	
Data solicitation (PC)	232	ASCII	# A A <CR>	
		MessBus	No - data is transmitted permanently	
	485	ASCII	# A A <CR>	
		MessBus	<SADR> <ENQ>	
Data transmission (instrument)	232	ASCII	> D [D] [D] [D] [D] [D] [D] [D] [D] [D] [D] <CR>	
		MessBus	<STX> D [D] [D] [D] [D] [D] [D] [D] [D] [D] [D] <ETX> <BCC>	
	485	ASCII	> D [D] [D] [D] [D] [D] [D] [D] [D] [D] [D] <CR>	
		MessBus	<STX> D [D] [D] [D] [D] [D] [D] [D] [D] [D] [D] <ETX> <BCC>	
Confirmation of data acceptance (PC) - OK	485	MessBus	<DLE> 1	
Confirmation of data acceptance (PC) - Bad		MessBus	<NAK>	
Sending address (PC) prior command		MessBus	<EADR> <ENQ>	
Confirmation of address (instrument)		MessBus	<SADR> <ENQ>	
Command transmission (PC)	232	ASCII	# A A N P [D] [D] [D] [D] [D] [D] [D] <CR>	
		MessBus	<STX> S N P [D] [D] [D] [D] [D] [D] [D] <ETX> <BCC>	
	485	ASCII	# A A N P [D] [D] [D] [D] [D] [D] [D] <CR>	
		MessBus	<STX> S N P [D] [D] [D] [D] [D] [D] [D] <ETX> <BCC>	
Command confirmation (instrument)	232	ASCII	OK	! A A <CR>
			Bad	? A A <CR>
		Messbus		No - data is transmitted permanently
		485	ASCII	OK
	Bad			? A A <CR>
	MessBus		OK	<DLE> 1
			Bad	<NAK>
	Instrument identification			# A A 1 Y <CR>
HW identification			# A A 1 Z <CR>	
One-time transmission			# A A 7 X <CR>	
Repeated transmission			# A A 8 X <CR>	

LEGEND

SIGN	RANGE	DESCRIPTION
#	35 23 _H	Command beginning
A A	0...31	Two characters of instrument address (sent in ASCII - tens and units, e.g. "01", "99" universal)
<CR>	13 00 _H	Carriage return
<SP>	32 20 _H	Space
N, P		Number and command - command code
D		Data - usually characters "0"... "9", "*", ".", ";", ":", "[]"; [D] - dp, and {} may prolong data
R	30 _H ...3F _H	Relay and tare status
!	33 21 _H	Positive confirmation of command (ok)
?	63 3F _H	Negative confirmation of command (point)
>	62 3E _H	Beginning of transmitted data
<STX>	2 02 _H	Beginning of text
<ETX>	3 03 _H	End of text
<SADR>	adresa +60 _H	Prompt to send from address
<EADR>	adresa +40 _H	Prompt to accept command at address
<END>	5 05 _H	Terminate address
<DLE>1	16 49 10 _H 31 _H	Confirm correct statement
<NAK>	21 15 _H	Confirm error statement
<BCC>		Check sum -XOR

RELAY, TARE

SIGN	RELAY 1	RELAY 2	TARE	CHANGE RELAY 3/4
P	0	0	0	0
Q	1	0	0	0
R	0	1	0	0
S	1	1	0	0
T	0	0	1	0
U	1	0	1	0
V	0	1	1	0
W	1	1	1	0
p	0	0	0	1
q	1	0	0	1
r	0	1	0	1
s	1	1	0	1
t	0	0	1	1
u	1	0	1	1
v	0	1	1	1
w	1	1	1	1

Relay status is generated by command #AA6X <CR>.

The instrument immediately returns the value in the format >HH <CR>, where HH is value in HEX format and range 00_H...FF_H. The lowest bit stands for „Relay 1“, the highest for „Relay 8“

10. ERROR STATEMENTS



ERROR	CAUSE	ELIMINATION
E.DI S_ _	Number is too small (large negative) to be displayed	change DP setting, channel constant setting
E.DI S_-	Number is too large to be displayed	change DP setting, channel constant setting
E.TAB_ _	Number is outside the table range	increase table values, change input setting (channel constant setting)
E.TAB_-	Number is outside the table range	increase table values, change input setting (channel constant setting)
E.I NP_ _	Input quantity is smaller than permitted input quantity range	change input signal value or input (range) setting
E.I NP_-	Input quantity is larger than permitted input quantity range	change input signal value or input (range) setting
E.Hw.	A part of the instrument does not work properly	send the instrument for repair
E.EE.	Data in EEPROM corrupted	perform restoration of manufacture setting, upon repeated error statement send instrument for repair
E.SET.	Data in EEPROM outside the range	perform restoration of manufacture setting, upon repeated error statement send instrument for repair
E.CLR	Memory was empty (presetting carried out)	upon repeated error statement send instrument for repair, possible failure in calibration
E.OUT.	Analogue output current loop disconnected	check wire connection



The instrument allows to add two descriptive characters to the classic numeric formats (at the expense of the number of displayed places). The setting is performed by means of a shifted ASCII code. Upon modification the first two places display the entered characters and the last two places the code of the relevant symbol from 0 to 95. Numeric value of given character equals the sum of the numbers on both axes of the table.

Description is cancelled by entering characters with code 00

	0	1	2	3	4	5	6	7		0	1	2	3	4	5	6	7
0		Q	"	&	\$	%	&	'	0	!	"	#	\$	%	&	'	
8	:	:	#	+	,	-	.	/	8	()	*	+	,	-	.	/
16	0	1	2	3	4	5	6	7	16	0	1	2	3	4	5	6	7
24	8	9	VA	Vr	<	=	>	?	24	8	9	VA	Vr	<	=	>	?
32	P	R	B	C	D	E	F	G	32	@	A	B	C	D	E	F	G
40	H	I	J	K	L	M	N	O	40	H	I	J	K	L	M	N	O
48	P	Q	R	S	T	U	V	W	48	P	Q	R	S	T	U	V	W
56	X	Y	Z	[\]	^	_	56	X	Y	Z	[\]	^	_
64	`	a	b	c	d	e	f	g	64	`	a	b	c	d	e	f	g
72	h	i	j	k	l	m	n	o	72	h	i	j	k	l	m	n	o
80	p	q	r	s	t	u	v	w	80	p	q	r	s	t	u	v	w
88	x	y	z	{		}	~		88	x	y	z	{		}	~	

12. TECHNICAL DATA

INPUT

range is adjustable

±60 mV	>100 MΩ	DC
±150 mV	>100 MΩ	Input U
±300 mV	>100 MΩ	Input U
±1200 mV	>100 MΩ	Input U

range is adjustable

		DC - option "A"
±0,1 A	< 300 mV	Input I
±0,25 A	< 300 mV	Input I
±0,5 A	< 300 mV	Input I
±1 A	< 30 mV	Input I
±5 A	< 150 mV	Input I
±100 V	20 MΩ	Input U
±250 V	20 MΩ	Input U
±500 V	20 MΩ	Input U

range is adjustable

		PM
0/4...20 mA	< 400 mV	Input I
±2 V	1 MΩ	Input U
±5 V	1 MΩ	Input U
±10 V	1 MΩ	Input U
±40 V	1 MΩ	Input U

range is adjustable

		OHM
0...100 Ω		
0...1 kΩ		
0...10 kΩ		
0...100 kΩ		
Autorange		

Connection: 2, 3 or 4 wire

Pt xxxx	-200°...850°C	RTD
Pt xxxx/3910 ppm	-200°...1 100°C	
Ni xxxx	-50°...250°C	
Cu/4260 ppm	-50°...200°C	
Cu/4280 ppm	-200°...200°C	
Type Pt:	EU > 100/500/1 000 Ω, with 3 850 ppm/°C	
	US > 100 Ω, with 3 920 ppm/°C	
	RU > 50/100 Ω, with 3 910 ppm/°C	

Type Ni:	Ni 1 000/ Ni 10 000 with 5 000/6 180 ppm/°C
Type Cu:	Cu 50/Cu 100 with 4 260/4 280 ppm/°C
Connection:	2, 3 or 4 wire

range is adjustable in configuration menu

Type:	J (Fe-CuNi)	-200°...900°C	T/C
	K (NiCr-Ni)	-200°...1 300°C	
	T (Cu-CuNi)	-200°...400°C	
	E (NiCr-CuNi)	-200°...690°C	
	B (PtRh30-PtRh6)	300°...1 820°C	
	S (PtRh10-Pt)	-50°...1 760°C	
	R (Pt13Rh-Pt)	-50°...1 740°C	
	N (Omega alloy)	-200°...1 300°C	
	L (Fe-CuNi)	-200°...900°C	

Voltage of lin. pot.	2,5 VDC/6 mA	DU
	min. potentiometer resistance is 500 Ω	

PROJECTION

Display:	30-segment 3-color bargraph red/green/orange
Auxiliary display	999999, intensive red or green 7 segment LED, digit height 9,1mm 30 LED/99999...999999
Projection:	
Decimal point:	adjustable - in menu
Brightness:	adjustable - in menu

INSTRUMENT ACCURACY

TC:	50 ppm/°C	
Accuracy:	±0,1% of range + 1 digit ±0,15% of range + 1 digit	RTD, T/C
	Above accuracies apply for projection 9999	
Resolution:	0,01/0,1/*	RTD
Rate:	0,1...40 measurements/s**	
Overload capacity:	10x (t < 100 ms) not for 500 V and 5 A, 2x (long-term)	
Linearisation:	by linear interpolation in 38 points - solely via OM Link	
Digital filters:	Averaging, Floating average, Exponential filter, Rounding	
Comp. of conduct:	max. 40 Q/100 Q	RTD
Comp. of cold junc.:	adjustable	T/C
	0°...99°C or automatic	
Functions:	Tare - display resetting Hold - stop measuring (at contact) Lock - control key locking MM - min/max value Mathematic functions	
OM Link:	company communication interface for setting, operation and update of instrument SW	
Watch-dog:	reset after 400 ms	
Calibration:	at 25°C and 40% of r.h.	

COMPARATOR

Type:	digital, adjustable in menu
Mode:	Hysteresis, From, Dosing
Limita:	-99999...999999
Hysteresis:	0...999999
Delay:	0...99,9 s
Outputs:	2x relays with switch-on contact (Form A) (230 VAC/30 VDC, 3 A)* 2x relays with switch-off contact (Form C) (230 VAC/50 VDC, 3 A)* 2x SSR (250 VAC/ 1 A)* 2x/4x open NPN collector (30 VDC/100 mA) 2x bistable relays (250 VAC/250 VDC, 3 A/0,3 A)*
Relay:	1/8 HP 277 VAC, 1/10 HP 125 V, Pilot Duty D300

* values apply for resistance load

DATA OUTPUTS

Protocols:	ASCII, DIN MessBus, MODBUS, PROBUS
Data format:	8 bit + no parity + 1 stop bit (ASCII) 7 bit + even parity + 1 stop bit (MessBus)
Rate:	600...230 400 Baud 9 600 Baud...12 Mbaud (PROFIBUS)
RS 232:	isolated, two-way communication
RS 485:	isolated, two-way communication, addressing (max. 31 instruments)
PROFIBUS	Data protocol SIEMENS

ANALOG OUTPUTS

Type:	isolated, programmable with 16 bits Q/A converter, analogoutput corresponds with displayed data, type and range are adjustable
Non-linearity:	0,1% of range
TC:	15 ppm/°C
Rate:	response to change of value < 1 ms
Voltage:	0...2 V/5 V/10 V/±10 V
Current:	0...5/20 mA/4...20 mA - compensation of conduct to 500 Ω/12 V or 1 000 Ω/24 V

MEASURED DATA RECORD

Type RTC:	time-controlled logging of measured data into instrument memory, allows to log up to 250 000 values
Type FAST:	fast data logging into instrument memory, allows to log up to 8 000 values at a rate of 40 records/s
Transmission:	via data output RS 232/485 or via QM Link

EXCITATION

Adjustbale:	5...24 VDC/max. 1,2 W, isolated
-------------	---------------------------------

POWER SUPPLY

Options:	10...30 V AC/DC, max. 13,5 VA, PF ≥ 0,4, $I_{LTP} < 40 \text{ A/1 ms}$, isolated - fuse inside (T 4000 mA)
	80...250 V AC/DC, max. 13,5 VA, PF ≥ 0,4, $I_{LTP} < 40 \text{ A/1 ms}$, isolated - fuse inside (T 630 mA)

MECHANIC PROPERTIES

Material:	Noryl GFN2 SE1, incombustible UL 94 V-I
Dimensions:	96 x 48 x 120 mm
Panel cut-out:	90,5 x 45 mm

OPERATING CONDITIONS

Connection:	connector terminal board, conductor cross-section <1,5 mm ² / <2,5 mm ²
Stabilisation period:	within 15 minutes after switch-on
Working temp.:	-20°...60°C
Storage temp.:	-20°...85°C
Cover:	IP64 (front panel only)
Construction:	safety class I
Dielectric strength:	4 kVAC after 1 min between supply and input 4 kVAC after 1 min between supply and data/ analog output 4 kVAC after 1 min between supply and relay output 2,5 kVAC after 1 min between supply and data/ analog output
Overvoltage cat.:	EN 61010-1, A2
Insulation resist.:	for pollution degree II, measurement cat. III instrum.power supply > 670 V (PI), 300 V (DI) Input/output > 300 V (PI), 150 (DI)
EMC:	EN 61326-1
Seismic resistance:	IEC 980: 1993, par. 6

**Table of rate of measurement in relation to number of inputs

Channels/Rate	40	20	10	5	2	1	0,5	0,2	0,1
No.of channels: 1 [Type: DC, PM, DU]	40,00	20,00	10,00	5,00	2,00	1,00	0,50	0,20	0,10
No.of channels: 2	5,00	2,50	1,25	1,00	0,62	0,38	0,22	0,09	0,05
No.of channels: 3	3,33	1,66	0,83	0,66	0,42	0,26	0,14	0,06	0,03
No.of channels: 4	2,50	1,25	0,62	0,50	0,31	0,19	0,11	0,05	0,02
No.of channels: 1 [Type: OHM, RTD, T/C]	5,00	2,50	1,25	1,00	0,62	0,38	0,22	0,09	0,05
No.of channels: 2	3,33	1,066	0,83	0,66	0,42	0,26	0,14	0,06	0,03
No.of channels: 3	2,50	1,25	0,62	0,50	0,31	0,19	0,11	0,05	0,02
No.of channels: 4	2,00	1,00	0,50	0,40	0,25	0,15	0,08	0,04	0,02

13. INSTRUMENT DIMENSIONS AND INSTALLATION



Front view

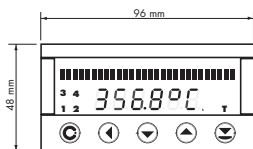

Panel cut

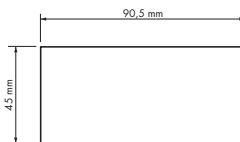

Side view

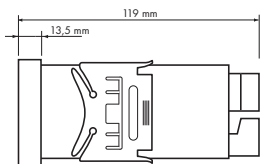

Panel thickness: 0.5...20 mm

INSTRUMENT INSTALLATION

1. insert the instrument into the panel cut-out
2. fit both travellers on the box
3. press the travellers close to the panel

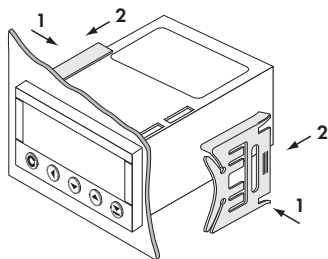
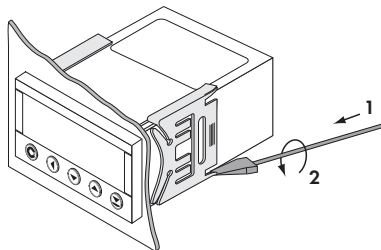

INSTRUMENT DISASSEMBLY

1. slide a screw driver under the traveller wing
2. turn the screw driver and remove the traveller
3. take the instrument out of the panel



Product **OMB 402UNI**
Type
Manufacturing No.
Date of sale

A

GUARANTEE

A guarantee period of 60 months from the date of sale to the user applies to this instrument.
Defects occurring during this period due to manufacture error or due to material faults shall be eliminated free of charge.

For quality, function and construction of the instrument the guarantee shall apply provided that the instrument was connected and used in compliance with the instructions for use.

The guarantee shall not apply to defects caused by:

- mechanic damage
- transportation
- intervention of unqualified person incl. the user
- unavoidable event
- other unprofessional interventions

The manufacturer performs guarantee and post.guarantee repairs unless provided for otherwise.

Y E A R S

Stamp, signature



Company: **ORBIT MERRET, spol. s r.o.**
Klánova 81/141, 142 00 Prague 4, Czech Republic, IDNo.: 00551309

Manufactured: **ORBIT MERRET, spol. s r.o.**
Vodňanská 675/30, 198 00 Prague 9, Czech Republic

declares at its explicit responsibility that the product presented hereunder meets all technical requirements, is safe for use when utilised under the terms and conditions determined by ORBIT MERRET, spol.s r.o. and that our company has taken all measures to ensure conformity of all products of the types referred-to hereunder, which are being brought out to the market, with technical documentation and requirements of the appurtenant Czech statutory orders.

Product: Programmable panel instrument

Type **OMB 402**

Version: UNI, PWR, RS

That has been designed and manufactured in line with requirements of:

Statutory order no. 17/2003 Coll., on low-voltage electrical equipment (directive no. 73/23/EHS)
Statutory order no. 616/2006 Coll., on electromagnetic compatibility (directive no. 2004/108/EHS)

The product qualities are in conformity with harmonized standard:

El. safety: EN 61010-1

EMC: EN 61326-1

Electronic measuring, control and laboratory devices – Requirements for EMC "Industrial use"
EN 50131-1, chap. 14 and chap. 15, EN 50130-4, chap. 7, EN 50130-4, chap. 8, [EN 61000-4-11, ed. 2],
EN 50130-4, chap. 9 [EN 61000-4-2], EN 50130-4, chap. 10, [EN 61000-4-3, ed. 2], EN 50130-4, chap. 11 [EN 61000-4-6],
EN 50130-4, chap. 12, [EN 61000-4-4, ed. 2], EN 50130-4, chap. 13 [EN 61000-4-5], EN 61000-4-8, EN 61000-4-9,
EN 61000-6-1, EN 61000-6-2, EN 65022, chap. 5 and chap. 6

Seismic resistance: IEC 980: 1993, par. 6

The product is furnished with CE label issued in 2007

As documentation serve the protocols of authorized and accredited organizations:

EMC: MO CR, Testing institute of technical devices, protocol no. 80/6-328/2006 of 15/01/2007

MO CR, Testing institute of technical devices, protocol no. EMI.80/6-333/2006 of 15/01/2007

Seismic resistance: VOP-026 Stemberk, protocol no.: 6430-109/2007 of 13/09/2007

Place and date of issue: Prague, 19. Juli 2010

Miroslav Hackl
Company representative

Assessment of conformity pursuant to §22 of Act no. 22/1997 Coll. and changes as amended by Act no.71/2000 Coll. and 205/2002 Coll