

USER MANUAL

NÁVOD K OBSLUZE

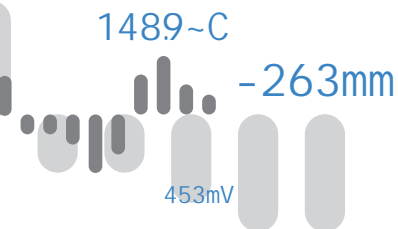

OMD 202UQC

6 DIGIT PROGRAMMABLE
LARGE DISPLAY

COUNTER
FREQUENCY METER
DUTY CYCLE MEASUREMENT
STOPWATCH/TIMER/CLOCK

DIGITAL PANEL METERS
PANELOVÉ MĚŘICÍ PŘÍSTROJE

BARGRAPHS
SLOUPCOVÉ ZOBRAZOVAČE

LARGE DISPLAYS
VELKOPLOŠNÉ DISPLEJE

TRANSMITTERS TO DIN RAIL
PŘEVODNÍKY NA LIŠTU

PAPERLESS RECORDERS
BEZPAPÍROVÉ ZAPISOVAČE

PLC

WARRANTY



SAFETY INSTRUCTIONS

Please read carefully the enclosed safety instructions and observe them!

Installation, all operational interventions, maintenance and service must be performed by a qualified personnel and in accordance with the attached information and safety regulations. The manufacturer is not liable for damage caused by improper installation, configuration, maintenance, and service.

The recorder must be installed according to the respective application. Incorrect installation can cause a malfunction, which can result in damage or accident.

The recorder uses dangerous voltages that can cause a fatal accident. Before you start solving problems (e.g. in case of failure or disassembly), the device must be disconnected from the power supply. For safety information the EN 61 010-1 + A2 standard must be observed.

When removing or inserting a card, observe the safety instructions and follow the recommended procedure. During any intervention the recorder must be disconnected from the power supply.

Do not attempt to repair or modify the device. A defective recorder must be sent for repair to the manufacturer.

These devices should be safeguarded by isolated or common fuses (breakers)!

The recorder is not designed for installation in potentially explosive surroundings (Ex). Use it only outside potentially explosive surroundings

TECHNICAL DATA

Measuring instruments of the OMD 202 series conform to the European regulation 2014/30/EU and 2014/35/EU

The instruments are up to the following European standards:

EN 61010-1 Electrical safety

EN 61326-1 Electronic measuring, control and laboratory devices – Requirements for EMC "Industrial use"

The recorders are applicable for unlimited use in agricultural and industrial areas.



ORBIT MERRET, spol. s r.o.
Vodnanska 675/30
198 00 Prague 9
Czech Republic

Tel: +420 - 281 040 200
Fax: +420 - 281 040 299
e-mail: orbit@merret.eu
www.orbit.merret.eu





1. CONTENTS	3
2. INSTRUMENT DESCRIPTION	4
3. INSTRUMENT CONNECTION	6
Measuring ranges.	6
Instrument conection.	7
Recommended connection of sensors.	8
Termination of RS 485 communication line.	9
Comparator level table	9
4. INSTRUMENT SETTING	10
Symbols used in the instructions.	12
Setting the DP and the (-) sing	12
Control keys functions.	13
Configuration of „User“ menu items	13
5. SETTING “LIGHT” MENU	14
5.0 Description “LIGHT” menu.	15
Access to menu	16
Setting current value	16
Selection of control „START“	17
Selection of control „STOP“	17
Setting of the inputs.	18
Setting multiplying constant, offset and projection format - channel Counter	20
Setting multiplying constant, offset and projection format - channel Frequency	24
Setting limits	28
Setting analog output	30
Setting the address of IR remote control	32
Setting the menu type (LIGHT/PROFI).	32
Restoration of manufacture setting	33
Selection of instrument menu language version. ...	33
Setting new access password	34
Instrument identification	34
6. SETTING “PROFI” MENU	36
6.0 Description “PROFI” men.	36
6.1 “PROFI” menu - INPUT	
6.1.1 Resetting internal values.	38
6.1.2 Instrument configuration.	39
6.1.3 Selection of inputs switching	52
6.1.4 Setting the Real Time	52
6.1.5 Setting external control input	53
6.1.6 Setting function of the control key.	55
6.2 “PROFI” menu - CHANNELS	
6.2.1 Setting calibration constants and offset	58
6.2.2 Setting mathematic functions	64
6.2.3 Selection of evaluation of min/max. value	68
6.3 “PROFI” menu - OUTPUTS	
6.3.1 Selection of excitation	70
6.3.2 Configuration and setting the limits	70
6.3.3 Setting data output	74
6.3.4 Setting analog output.	75
6.3.5 Setting display brightness	77
6.4 “PROFI” menu - SERVICE	
6.4.1 Setting the address of IR remote control ...	80
6.4.2 Selection of programming menu „LIGHT“/„PROFI“	81
6.4.3 Restoration of manufacture setting.	81
6.4.4 Selection of inst. menu language version. ...	82
6.4.5 Setting new access password	83
6.4.6 Instrument identification	83
7. SETTING “USER” MENU	84
8. DATA PROTOCOL	86
9. ERROR STATEMENTS	88
10. TABLE OF SYMBOLS	89
11. TECHNICAL DATA	90
12. INSTRUMENT DIMENSION AND INSTALLATION ...	92
13. CERTIFICATE OF WARRANTY	93

2. INSTRUMENT DESCRIPTION

2.1 DESCRIPTION

The OMD 202UQC model series are 4/6 digit large panel programable counter/frequency meter/IRC signal monitor/stopwatch/clock instrument. It comes either with a 3-colour LED display (red/green/orange) or with High Brightness LEDs (red or green with brightness of 1 300 mcd).

It is based on a single microprocessor and a powerful gate array which ensure high accuracy, stability and easy controlling.

MEASURING MODES

SINGLE	Counter/Frequency meter	C / F
A'B	Counter/Frequency meter with function AND between inputs A and B	C / F
xNOR	Counter/Frequency meter with function NOR between inputs A and B	C / F
DUTY	Duty cycle measurement	C / F
QVADR	Counter/Frequency meter for IRC encoders	C / F
UP/DW	UP/DW Counter/Frequency meter - measures on inputs A, B (B defines direction) and can display count/frequency	C / F
UP + DW	UP + DW Counter/Frequency meter C / F - measures on inputs A (UP), B (DW) and can display count/frequency	C / F
TIME	Stopwatch	H
RTC	Clock	H

PROGRAMABLE DISPLAY PROJECTION

Calibration	it is possible to set the calibration coefficients in the programming menu
Projection	-99999...999999 with fixed or floating decimal point, for measuring modes STOPWATCH/CLOCK with the option to set in the format 10/24/60
Measuring channels	it is possible to process two independent functions (counter/frequency)
Time base	0,05 s/0,5 s/1 s/2 s/5 s/10 s/20 s/1 min/2 min/5 min/10 min/15 min

LINEARIZATION

Linearization by linear interpolation in 45 points/channel (solely via OM Link)

DIGITAL FILTERS

Input filter:	Input filter processes the input signal and reduces/eliminates interference (such as false signals originating from closing/opening relay contacts). The value entered represents the top measured frequency (for duty cycle 50% - identical period of Hi/Lo level), which the instrument will be able to process. - off/1 MHz/500 kHz/250 kHz/100 kHz/1 kHz/100 Hz/65 Hz/45 Hz/10 Hz/.../10 min - filter for shaft revolution measurement (setting a whole no. of pulses per revolution) - blocking (extending) the input pulse to a defined length 0...120 s
Floating average:	from 2...30 measurements
Exponen.average:	from 2...100 measurements
Arithmetic average:	from 2...100 measurements
Rounding:	setting the projection step for display

FUNCTIONS

Setting the value	Entering the current count when installing the counter during a counting cycle
Preset	initial non-zero value, unloaded always after instrument resetting
Summation	registration of the number upon shift operation
Tare	designed to reset display upon non-zero input signal
OM Link	company communication interface for setting, operation and update of instrument SW



EXTERNAL CONTROL

Lock:	control keys blocking
Hold:	display/instrument blocking
Tare:	tare activation/resetting tare to zero
Resetting MM	resetting min/max value
Resettting	resetting/pre-setting the counter
Start/Stop	stopwatch/timer control
Pause	stopwatch/timer control

2.2 OPERATION

The instrument is set and controlled by IR Remote control. All programmable settings of the instrument are performed in three adjusting modes:

- LIGHT** Simple programming menu
 - contains solely items necessary for instrument setting and is protected by optional number code
- PROFI** Complete programming menu
 - contains complete instrument menu and is protected by optional number code
- USER** User programming menu
 - may contain arbitrary items selected from the programming menu (LIGHT/PROFI), which determine the right (see or change)
 - acces without password

All programmable parameters are stored in the EEPROM memory (they hold even after the instrument is switched off).

OMLINK Complete instrument operation and setting may be performed via OM Link communication interface, which is a standard equipment of all instruments.

The operation are freely accessible (www.orbit.merret.cz) and the only requirement is the purchase of OML cable to connect the instrument to PC. It is manufactured in version RS 232 and USB and is compatible with all ORBIT MERRET instruments. Another option for connection is with the aid of data output RS 232 or RS 485 (without the need of the OML cable).

The program OM LINK in „Basic“ version will enable you to connect one instrument with the option of visualization and archiving in PC. The OM Link „Standard“ version has no limitation of the number of instruments connected.

2.3 OPTION

Excitation is suitable for supplying power to sensors and transmitters. It has a galvanic separation.

Comparators are assigned to monitor one, two, three or four limit values with relay output. The following modes for limits are custom selectable: „Hysteresis“ / „Reset and generate one pulse“ for the first relay and for the stopwatch it is also „to close“ action when the stopwatch/clock for the second relay. The limits have adjustable hysteresis within the full range of the display as well as selectable delay of the switch-on in the range of 0...99,9 s. Reaching the preset limits is signalled by LED and simultaneously by the switch-on of the relevant relay.

Data outputs are for their rate and accuracy suitable for transmission of the measured data for further projection or directly into the control systems. We offer an isolated RS232 and RS485 with the ASCII, MESSBUS, MODBUS - RTU or PROFIBUS protocol.

Analog outputs will find their place in applications where further evaluating or processing of measured data is required in external devices. We offer universal analog output with the option of selection of the type of output - voltage/current. The value of analog output corresponds with the displayed data and its type and range are selectable in Menu.

Time backup by means of RTC circuit is designed for the „TIMER“ measuring mode and secures time measuring even if the instrument is switched-off (without display projection).

2. INSTRUMENT CONNECTION

The instrument supply leads should not be in proximity of the incoming low-potential signals.

Contactors, motors with larger input power should not be in proximity of the instrument.

The leads into the instrument input (measured quantity) should be in sufficient distance from all power leads and appliances. Provided this cannot be secured it is necessary to use shielded leads with connection to ground (bracket E).

The instruments are tested in compliance with standards for use in industrial area, yet we recommend to abide by the above mentioned principles.

Functions of inputs according to selected mode

MODE	DESCRIPTION	FUNCTIONS OF INPUTS
SINGLE	Pulse counter/Frequency counter	Input A, Resetting (Input C)
A * B	Pulse counter/Frequency counter with function AND	Input A x B, Resetting (Input C)
XNOR	Pulse counter/Frequency counter with function xNOR	Input $\overline{A + B}$, Resetting (Input C)
DUTY	Duty	Input A
QUADR.	Pulse counter/ Frequency counter for IRC sensors	Input A + Input B, Resetting (Input C)
UP/DW	UP or DW Pulse counter/Frequency counter	Input A, Input B - determines direction (Hi = UP, Lo = DW) Resetting (Input C)
UP+DW	UP/DW Pulse counter/Frequency counter	Input A (UP), Input B (DW), Resetting (Input C)
TIME	Stopwatch Clock (time base 29 MHz)	Input A, Input B (Resetting - M.STOP), Resetting (Input C), M. NUL.
RTC	Stopwatch Clock with time back up (time base 1 s)	Input A, Input B (Resetting - M.STOP), Resetting (Input C), M. NUL.

CONNECTION

	DESCRIPTION	CONNECTION
INPUT A	input signal < 60 V	GND + Input A
INPUT B	input signal < 60 V	GND + Input B
INPUT C	input signal < 60 V	GND + Input C/Resetting

EXTERNAL INPUTS

	DESCRIPTION	CONTROL
EXT. 1/2/3	According to setting in Menu (see Menu > EXT. IN., page 48)	upon contact, bracket (No. 14 + 15/16/17)

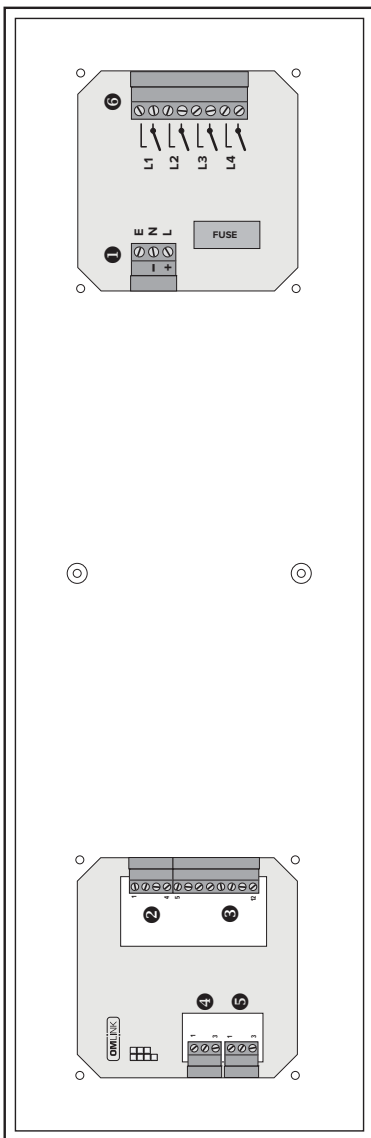

4 Analogue output*

- 1 □ AO +U
- 2 □ AO -I
- 3 □ GND

5 Data output*

- 1 □ BOUT+
- 2 □ TOUT-
- 3 □ GND

*Option

2 External inputs



3 Input

- Standard
- 1 □ Excitation
- 2 □ GND
- 3 □ INPUT C/ Reset
- 4 □ INPUT B
- 5 □ INPUT A
- 6 □ INPUT C
- 7 □ INPUT E
- 8 □ INPUT B
- 9 □ INPUT A
- 10 □ INPUT E
- 11 □
- 12 □

Line

- 1 □ Excitation
- 2 □ GND
- 3 □ INPUT C/ Reset
- 4 □ INPUT B
- 5 □ INPUT A
- 6 □ INPUT C
- 7 □ INPUT E
- 8 □ INPUT B
- 9 □ INPUT A
- 10 □ INPUT E
- 11 □ INPUT B
- 12 □ INPUT A

1 Power supply

- 1 □ E
- 2 □ N
- 3 □ L

6 Relays*

3. INSTRUMENT CONNECTION

Sensor connection

2-wire sensors

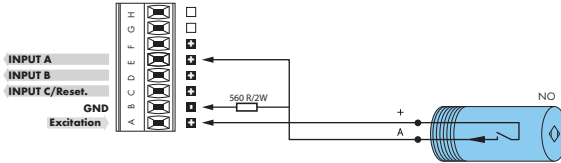

3-wire sensors

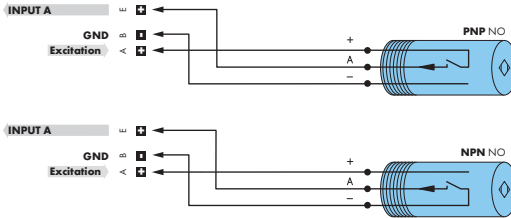

contact



IRC sensors

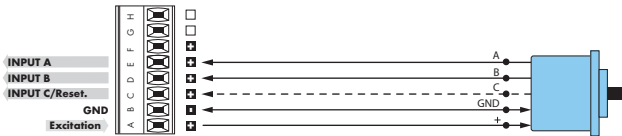

Sensors with PNP or NPN output have always only one „fixed“ level and therefore it is extremely important the leads are properly shielded and separated from possible sources of interference. If interference occurs, it can be included in the measurement. One of the ways of eliminating this possible problem is applying an input signal filter in the Menu.

Termination of RS 485 communication line

X3 - Termination of communication line RS 485

Full	Significance	Default	Recommendation
1-2	connect L+ to (+) source	terminalconnected	
3-4	termination of line 120 Ohm	disconnected	connect at the end of line
5-6	connect L- to (-) source	terminalconnected	do not disconnect

RS 485 line should have a linear structure - wires (ideally shielded and twisted) should lead from one device to another.

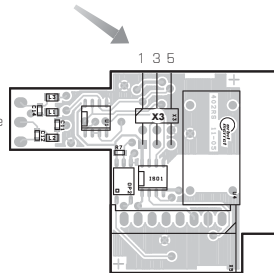

Comparator levels

Setting comparator levels for individual inputs is realised in the „LIGHT“ or in the „PROFI“ menu.

When setting the level manually by front panel buttons please set the required value first, then confirm by pressing the „ENTER“ button. The value you have selected is automatically adjusted to the corresponding comparator level (see the table below).

COMPARATOR LEVEL TABLE (V)

TYPE	LEVEL (V)
standard	0,42 • 1,38 • 1,80 • 2,37 • 3,18 • 4,57 • 5,98 • 7,34 • 8,72 10,27 • 10,58 • 11,95 • 13,33 • 15,18 • 18,17 • 19,77 • 24,37
amplified (100x)	0,004 • 0,014 • 0,018 • 0,024 • 0,032 • 0,046 • 0,060 • 0,073 • 0,087 • 0,103 • 0,106 • 0,120 • 0,133 • 0,152 0,182 • 0,198 • 0,244 • 0,261 • 0,290 • 0,340 • 0,397

For an easier setting of inputs and the input levels the front panel LEDs signal their momentary state (it is necessary to wait for a approx 2 s).

LED „C“	input A
LED „F“	amplified input A
LED „1“	input B
LED „2“	input C

Amplified inputs

- only A
- in case you enter voltage lower input A than 0.8304 the input is processed by pre-amplifier (which limits the frequency range), input B automatically (if necessary) switches over to amplified input B (< 100 mV) and therefore it is essential, if A2 is used as input B to the counter, to select identical parameters AB

SETTING PROFI

For expert users

Complete instrument menu

Access is password protected

Possibility to arrange items of the **USER MENU**

Tree menu structure

SETTING LIGHT

For trained users

Only items necessary for instrument setting

Access is password protected

Possibility to arrange items of the **USER MENU**

Linear menu structure

SETTING USER

For user operation

Menu items are set by the user (Profi/Light) as per request

Access is not password protected

Optional menu structure either tree (PROFI) or linear (LIGHT)

4.1 SETTING

The instrument is set and controlled by IR Remote control. All programmable settings of the instrument are performed in three adjusting modes:

- LIGHT** **Simple programming menu**
 - contains solely items necessary for instrument setting and is protected by optional number code
- PROFI** **Complete programming menu**
 - contains complete instrument menu and is protected by optional number code
- USER** **User programming menu**
 - may contain arbitrary items selected from the programming menu (LIGHT/PROFI), which determine the right (see or change)
 - acces without password

Complete instrument operation and setting may be performed via OM Link communication interface, which is a standard equipment of all instruments.

The operation program is freely accessible (www.orbit.merret.cz) and the only requirement is the purchase of OML cable to connect the instrument to PC. It is manufactured in version RS 232 and USB and is compatible with all ORBIT MERRET instruments. Another option for connection is with the aid of data output RS 232 or RS 485 (without the need of the OML cable).

Scheme of processing the measured signal

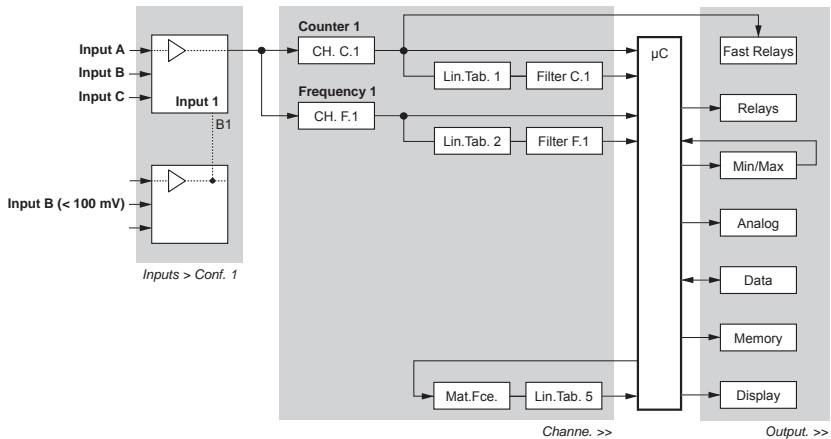

4. INSTRUMENT SETTING

Setting and controlling the instrument is performed by means of the Remote control. With the aid of the Remote control it is possible to browse through the operation menu and to select and set the required values.

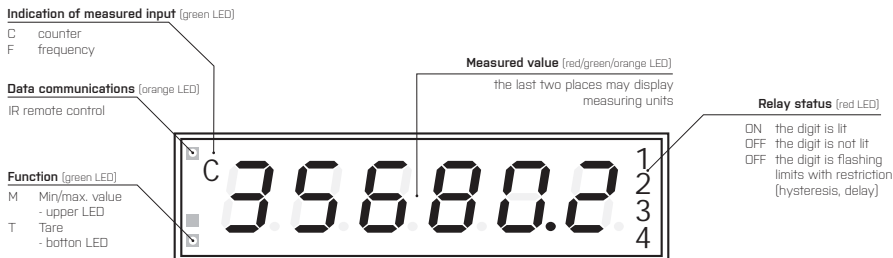

Symbols used in the instructions

C F H Q Indicates the setting for given type of instrument

DEF values preset from manufacture

symbol indicates a flashing light (symbol)

inverted triangle indicates the item that can be placed in USER menu

broken line indicates a dynamic item, i.e. it is displayed only in particular selection/version

after pressing the key the set value will not be stored

after pressing the key the set value will be stored

30 continues on page 30

Setting the decimal point and the minus sign











DECIMAL POINT

Its selection in the menu, upon modification of the number to be adjusted it is performed by the control key with transition beyond the highest decade, when the decimal point starts flashing. Positioning is performed by .

THE MINUS SIGN

Setting the minus sign is performed by the key on higher decade. When editing the item subtraction must be made from the current number (e.g.: 013 > , on class 100 > -87)

Control keys functions

KEY	MEASUREMENT	MENU	SETTING NUMBERS/SELECTION
	access into USER menu	exit menu w/o saving	transition to next item w/o saving
	programmable key function	return to previous level	move to higher decade*
	programmable key function	move to previous item	move down*
	programmable key function	move to next item	move up*
	programmable key function	confirm selection	setting/selection confirmation
	access into LIGHT/PROFI menu		
>3 s 	direct access into PROFI menu		
		configuration of an item for "USER" menu	
		determine the sequence of items in "USER - LIGHT" menu	
	cancelation of address instrument/remote controler		



* alternatively, the setting may be done from the numeric keys of the remote control by selecting directly the number required

Setting items into „USER“ menu

- in **LIGHT** or **PROFI** menu
- no items permitted in **USER** menu from manufacture
- on items marked by inverted triangle

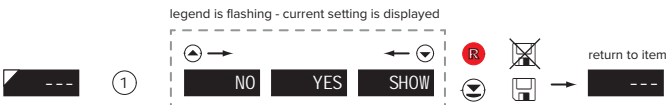
USER



-  item will not be displayed in USER menu
-  item will be displayed in USER menu with the option of setting
-  item will be solely displayed in USER menu

SETTING LIGHT

For trained users

Only items necessary for instrument setting

Access is password protected

Possibility to arrange items of the USER MENU

Linear menu structure

Preset from manufacture

Password	"0"
Menu	LIGHT
USER menu	vypruté
Setting the items	DEF

!

Upon delay exceeding 60 s the programming mode is automatically discontinued and the instrument itself restores the measuring mode

Access password
 1428 PASSW 0

Current value
 SET.C1 0

Setting stopwatch - Channel 1
 MSTART CONTAC

Resetting stopwatch - Channel 1
 MSTOP STOP

ONLY FOR MODE „STOPWATCH“

Type of input A, B
 TYPE 1 NPNCON

Voltage level - input A, B
 LEV. 1 24

Type of input C
 TYP.C1 NPNCON

Voltage level - input C
 LEV.C1 24

Setting of projection - Channel, counter
 SCALE 1 DI V.D. 1 OFFSET 0 SHOW 000000

Primary color
 COL0 C GREEN

First color limit
 LIM1 C 16667

Color beyond first limit
 COL1 C ORANGE

Second color limit
 LIM2 C 33333

Color beyond second limit
 COL2 C RED

Setting of projection - Channel, frequency
 SCALE 1 DI V.D. 1 OFFSET 0 SHOW 00000.0

Primary color
 COL0 F GREEN

First color limit
 LIM1 F 16667

Color beyond first limit
 COL1 F ORANGE

Second color limit
 LIM2 F 33333

Color beyond second limit
 COL2 F RED

LIM.L1 500 LIM.L2 1000 LIM.L3 1500 LIM.L4 2000
 Option - Comparator

TYP.A0 4-20mA MIN.A0 0 MAX.A0 1000
 Option - Analog output

Remote controller address
 ADR.I.R 0

Menu type
 MENU LIGHT

Return to manufacture setting
 RE.SET USER

Language selection
 LANG ENGL

New password
 PAS.U 0

Identification
 IDENT YES

Type of instrument
 OMD 202UOC

SW version
 76-001

input
 PLD01

1428 Return to the measuring mode

5. SETTING LIGHT

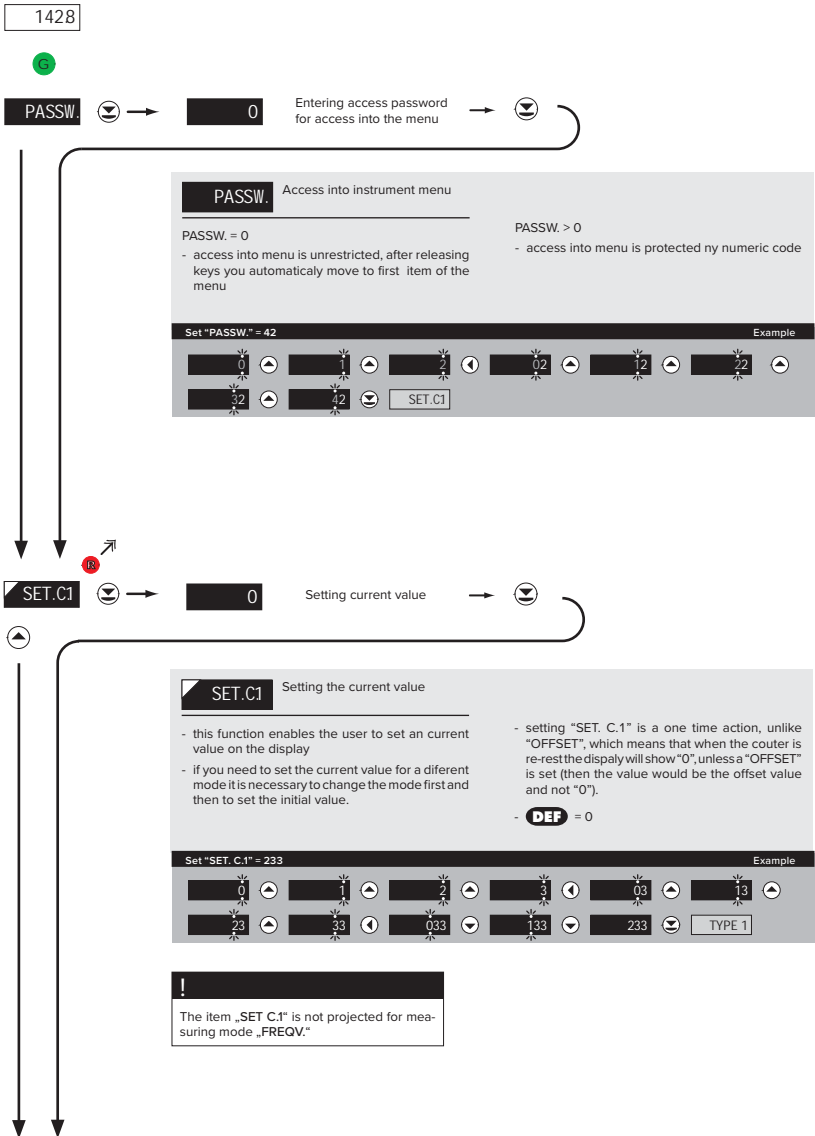



M.START Selection of stopwatch/timer control

- menu for time setting is accessible only in the stopwatch/timer mode

CONTI.N. Stopwatch/timer is running constantly if the instrument is turned on	CRUN.ST. Stopwatch/timer is controlled and reset by the edge of the priming signal - time is set off by the edge (by the signal passing across the comparing level) and stopped by the next edge
CONTAC. Stopwatch/timer is running upon contact making	CLR.RUN. Stopwatch/timer is reset and set off by the edge of the priming signal
EDGE Stopwatch/timer is controlled by the priming signal edge - time is set off by the edge (by the signal passing across the comparing level) and stopped by the next edge	CLR.RE. Stopwatch/timer is reset and set off by the edge of the priming signal, the cycle is repeated with every other edge
RUN.STC. Stopwatch/timer is controlled and reset by the edge of the priming signal - time is set off by the edge (by the signal passing across the comparing level) and stopped by the next edge	RUN Stopwatch/timer is only set off by the edge

DEF = **CONTAC.**

Selection of stopwatch contro > EdGE Example

CONTAC. **EDGE** **M.STOP**



M.STOP Selection of stopwatch resetting

- menu of the resetting option is accessible only in the stopwatch/timer regime

DEF = **OFF**

OFF Stopwatch/timer is reset through input „Clear“
ST.CLR Stopwatch/timer is stopped and reset through input „Clear“
STOP Stopwatch/timer is stopped through input „Clear“

Selection of type of stopwatch resetting > St. CL. Example

OFF **ST.CLR** **TYPE 1**

5. SETTING LIGHT

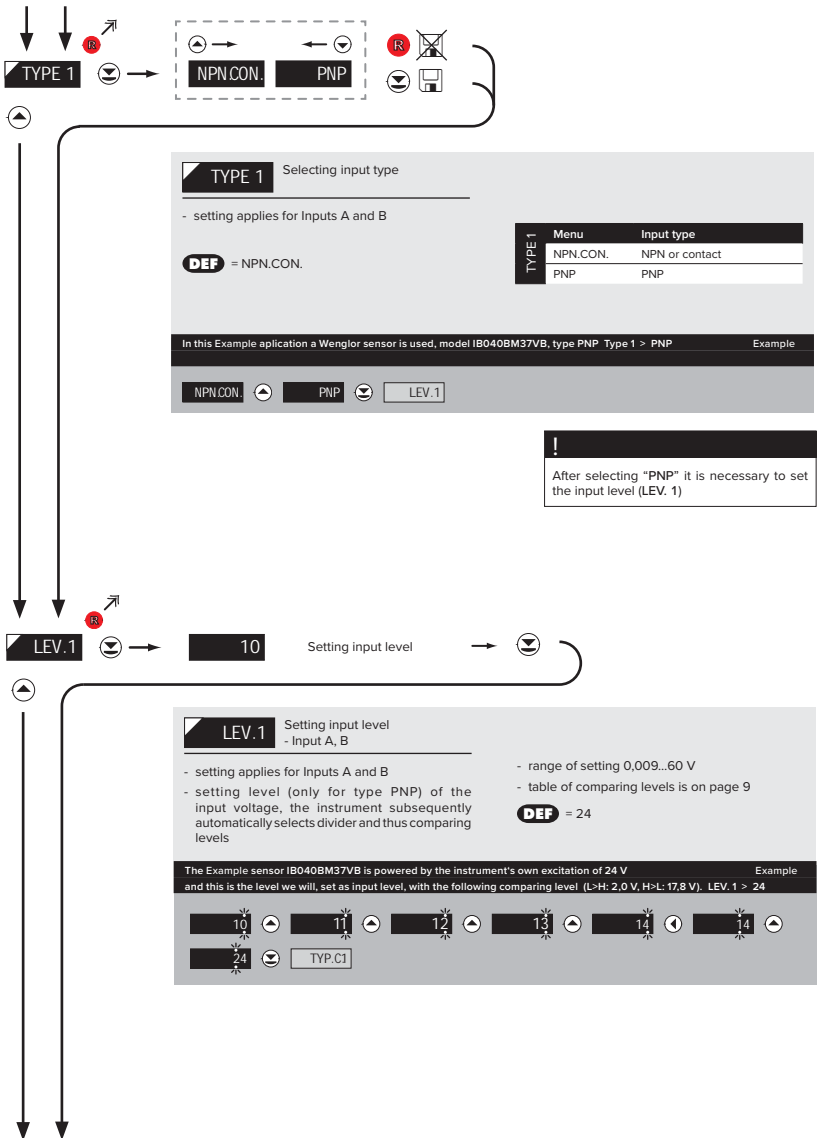

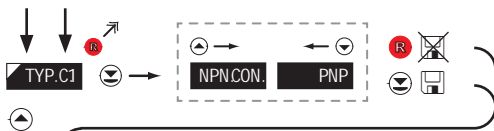

TYP.C1 Selecting input type

- setting applies for Input C

DEF = NPN.CON.

TYP.C1	Menu	Input type
	NPN.CON.	NPN or contact
	PNP	PNP

Resetting of the instrument will be done by a psh button (contact) connected to terminals no. 12/14. Example
TYP.C1 - nPn.CON.

NPN.CON. LEV.C1

!

After selecting "PNP" it is necessary to set the input level (LEV. 1)

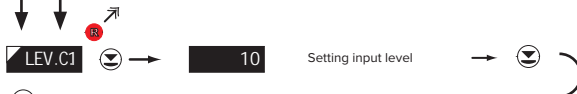

LEV.C1 Setting input level

- Input C (Resetting)

- setting applies for Input C

- setting level (only for type PNP) of the input voltage, the instrument subsequently automatically selects divider and thus comparing levels

- range of setting 0,009...60 V

- table of comparing levels is on page 9

DEF = 24

In the previous type selection we chose „nPn.CON“, so this option is not available now. Example
If our choice had been „PNP“ it is necessary to set the comparing level at this stage (see setting Level.A)

signalling active channel

5. SETTING LIGHT

MEASURING MODE > „COUNTER“

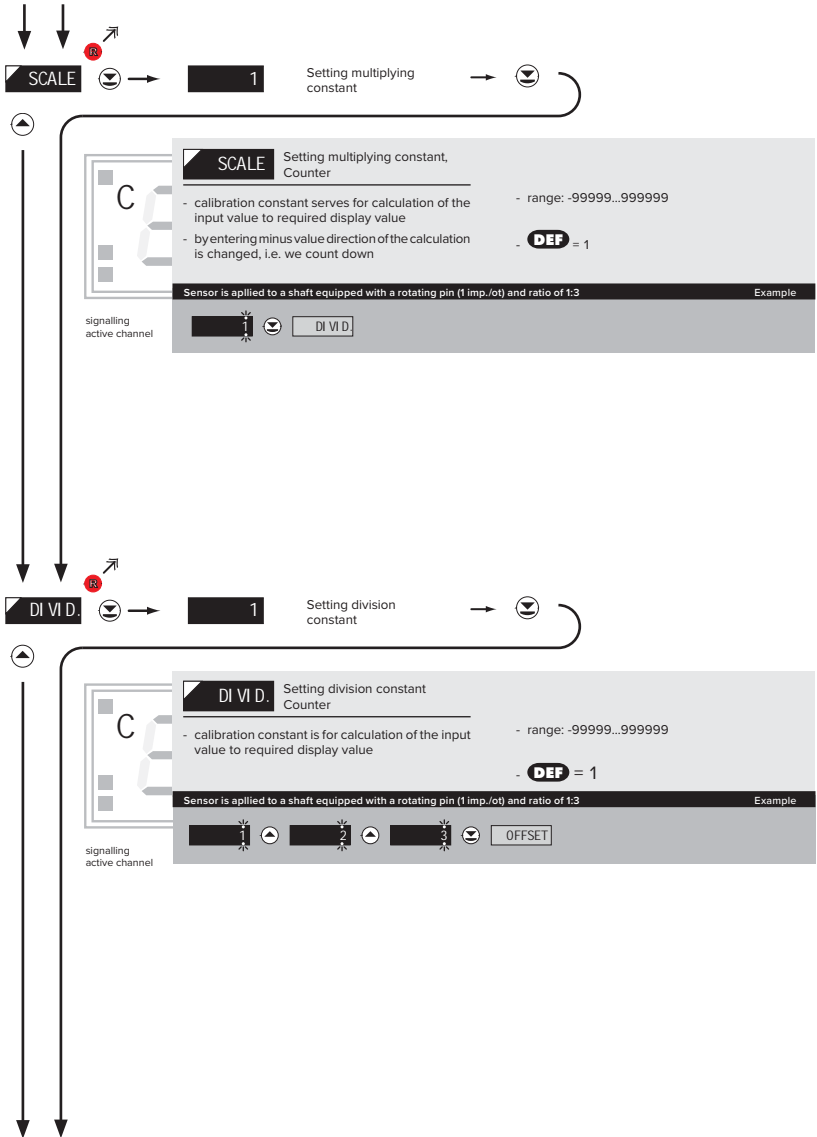

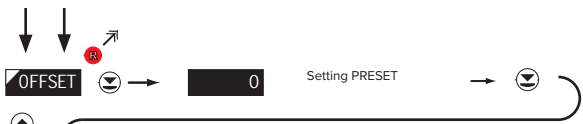

OFFSET Setting PRESET constant Counter

- offset of the measuring by a set value, which shall be loaded always upon instrument resetting
- range: -99999...999999 (+ time formats)
- in mode „STOP WATCH“ and constant > 0 the number sign will change automatically (page. 54)
- **DEF** = 0

Setting „OFFSET“ = 24 Example

signalling active channel

0	1	2	3	4	04
14	24				

SHOW



H

DDHHMM	DHHMM.C	HHHHMM	HHMMSS	HMMSS.C	99MMSS	MMMMSS	99SS.CC
MMSS.CC	MSS.CCC						

SHOW. Setting projection format, Counter

- the displayed value can either have a fixed decimal point, or floating, which allows the most optimal value projection in relation to the instrument's accuracy. The floating decimal point is marked as „FLOA. P.“
- special time formats are pre-set for measuring modes „TIME“ and „RTC“.
- **DEF** = 000000
- **DEF** = HH.MM.SS **H**

Projection of decimal point on the display > 000000 Example

signalling active channel

000000	COLD C
--------	--------

5. SETTING LIGHT

MEASURING MODE > „COUNTER“

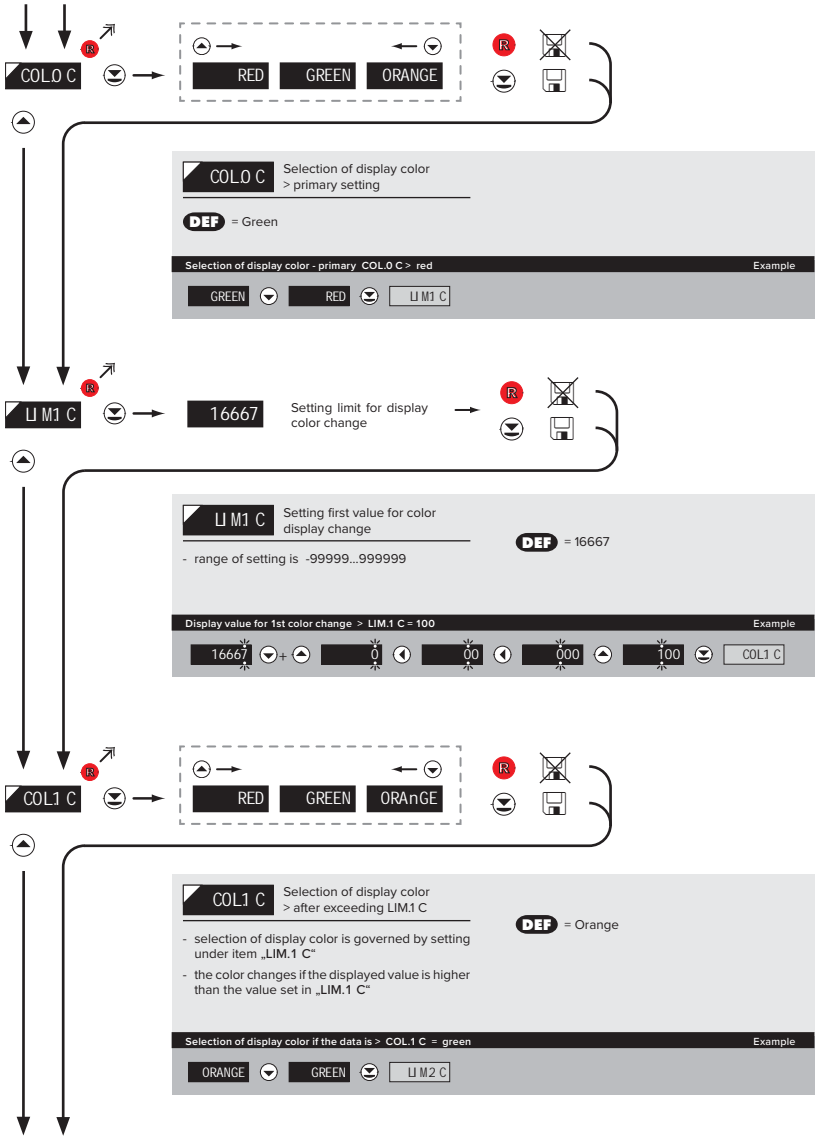

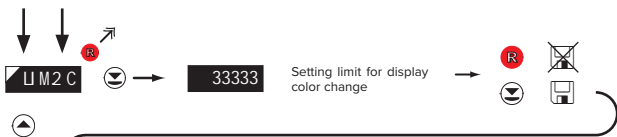

LIM.2 C Setting second value for display color change **DEF** = 33333

- range of setting is -99999...999999

Display value for 2st color change > LIM.2 C = 400 Example

33333	+	0	-	00	-	000
200	+	300	+	400	-	COL.2 C



COL.2 C Selection of display color > after exceeding LIM.2 C **DEF** = Red

- selection of display color is governed by setting under item „LIM.2 C“

- the color changes if the displayed value is higher than the value set in „LIM.2 C“

Selection of display color if the data is > LIM.2 C > orange Example

RED	-	ORANGE	-	SCALE
-----	---	--------	---	-------

5. SETTING LIGHT

MEASURING MODE > „FREQUENCY“

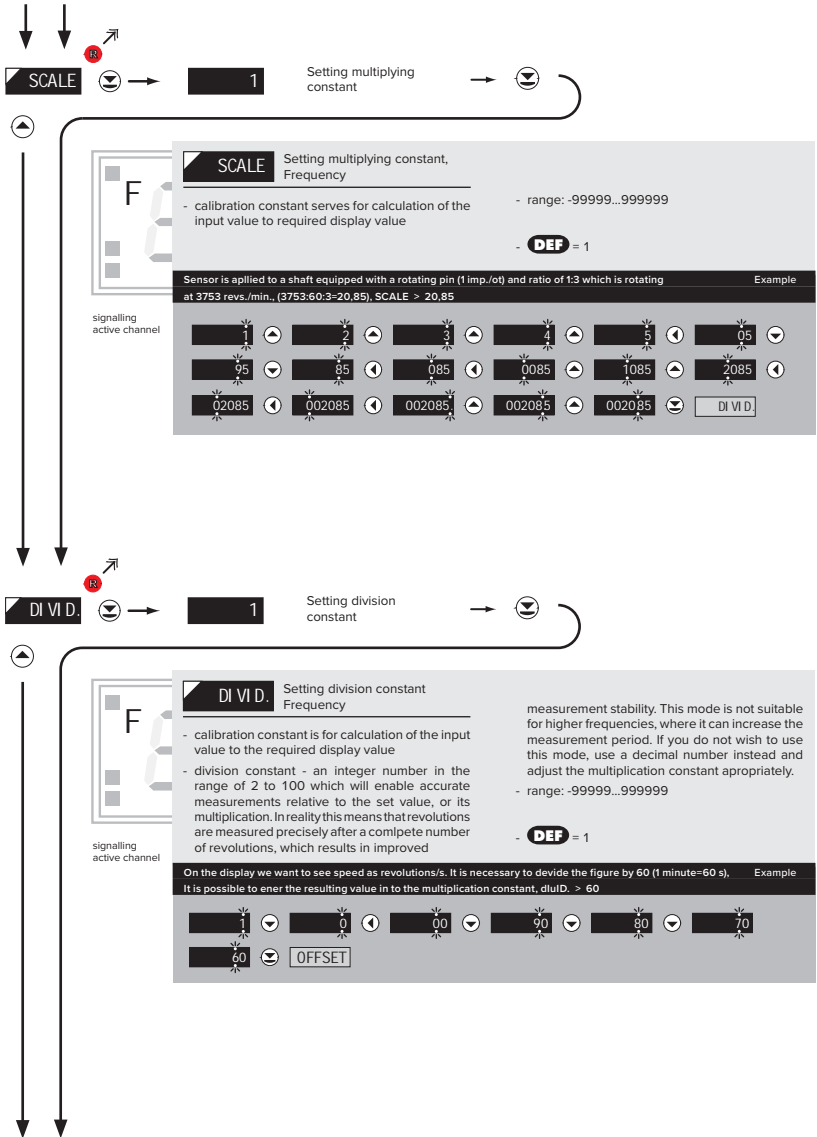

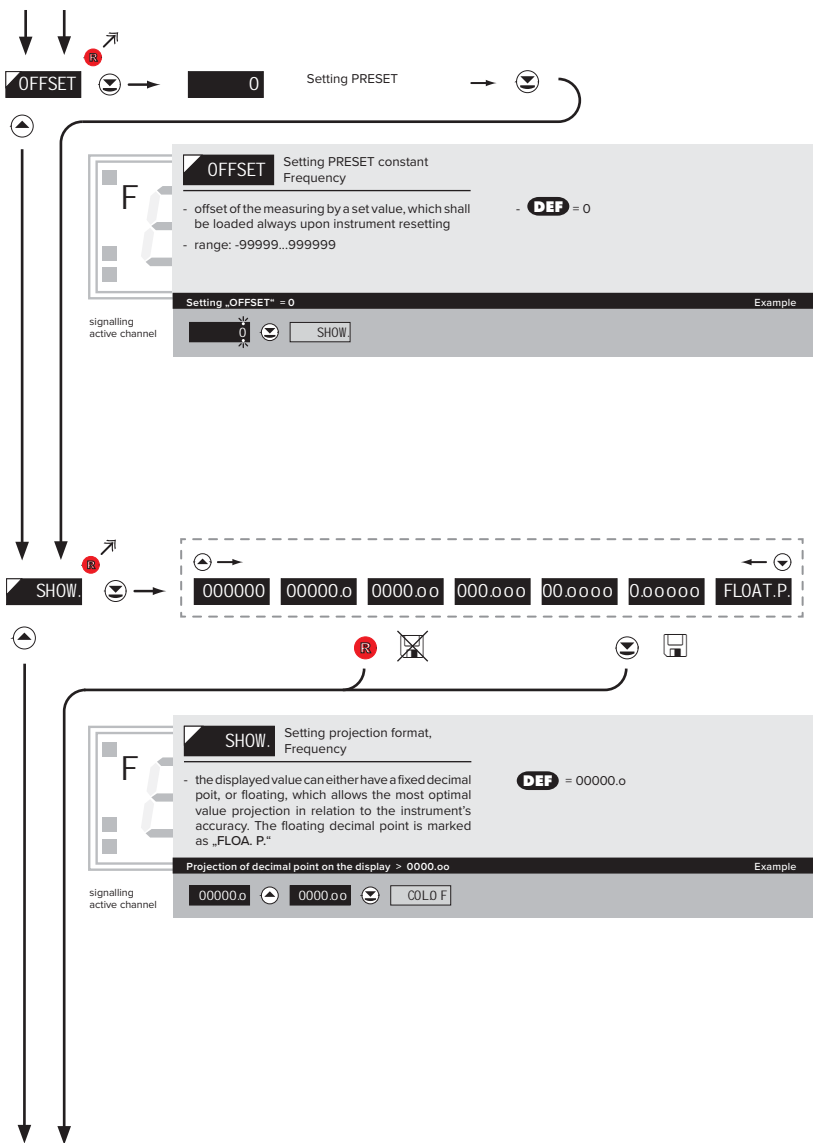

5. SETTING LIGHT

MEASURING MODE > „FREQUENCY“

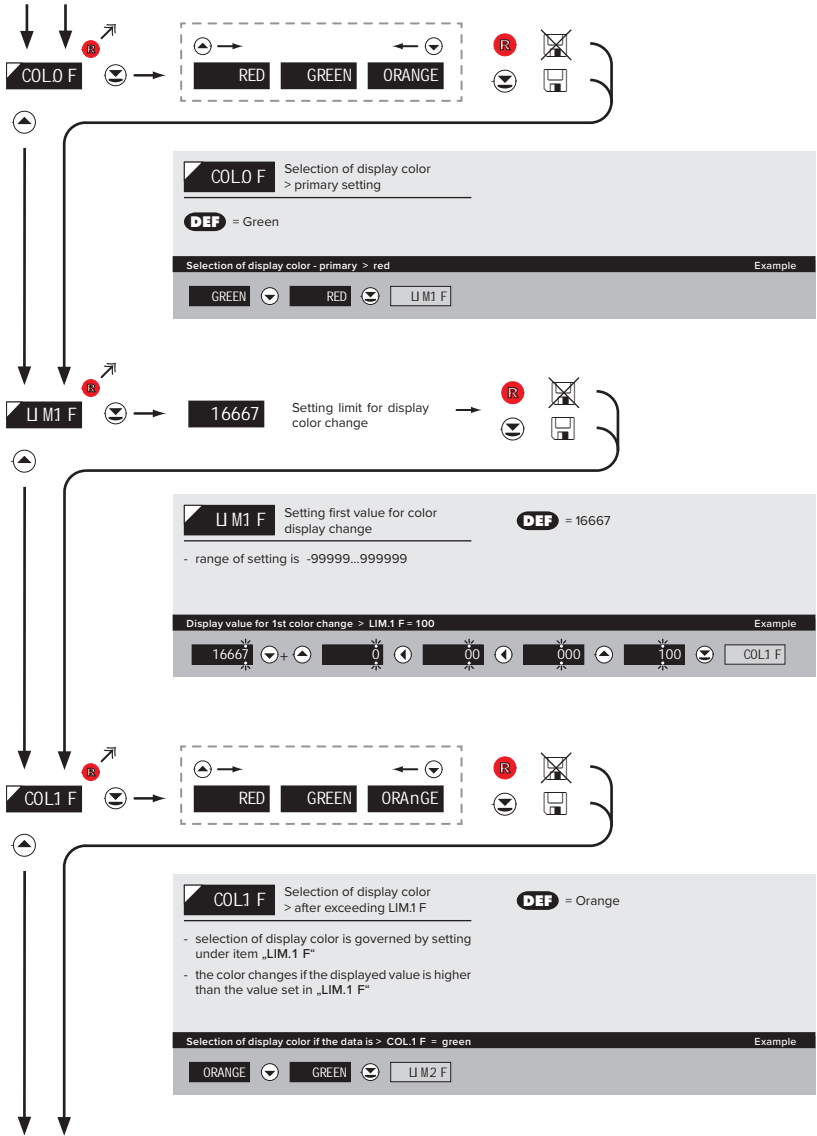

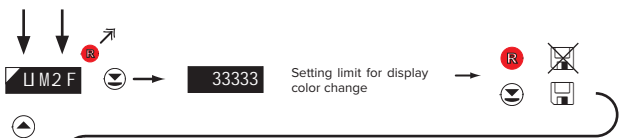

LIM.2 F Setting second value for display color change **DEF** = 33333

- range of setting is -99999...999999

Display value for 1st color change > LIM.2 F = 400 Example

33333	+	0	00	000	
200		300	400	COL.2 F	



COL.2 F Selection of display color > after exceeding LIM.2 F **DEF** = Red

- selection of display color is governed by setting under item „LIM.2 F“

- the color changes if the displayed value is higher than the value set in „LIM.2 F“

Selection of display color if the data is > LIM.2 F > orange Example

RED	ORANGE	ADR. I R
-----	--------	----------

* subsequent item on the menu depends on instrument equipment

5. SETTING LIGHT

DISPLAYED ONLY WITH OPTIONS > COMPARATORS



LIM.L1 Setting boundary for limit 1

- range of the setting: -99999...999999
- contingent modification of hysteresis or delay may be performed in "PROFI" menu

DEF = 500
DEF „Hysteresis“=0, „Delay“=0

Setting limit 1 > LIM.L1 = 512 Example

501 501 502 502 512

MENU



LIM.L2 Setting boundary for limit 2

- range of the setting: -99999...999999
- contingent modification of hysteresis or delay may be performed in "PROFI" menu

DEF = 1000
DEF „Hysteresis“=0, „Delay“=0

Setting limit 2 > LIM.L2 = 159.1 Example

1000 1001 1001 1091 1091 1191

1291 1391 1491 1591 1591 01591

001591 001591 001591

MENU

* subsequent item on the menu depends on instrument equipment

!

As a default setting, limits are active for the outer input "COUNT." To change the input type to which the limits will be responding change the setting in item "RE. SET." or by switching into "PROFI Menu" in item "INP.L1"

!

Items for "Limits" and "Analog output" are accessible only if incorporated in the instrument



DISPLAYED ONLY WITH OPTIONS > COMPARATORS

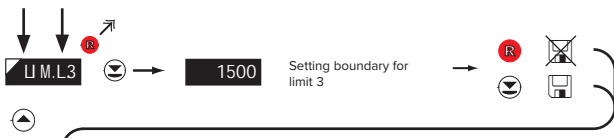

U M.L.3 Setting boundary for limit 3

- range of the setting: -99999...999999
- contingent modification of hysteresis or delay may be performed in "PROFI" menu

DEF = 1500
DEF „Hysteresis“=0, „Delay“=0

Setting limit 3 > LIM. L.3 = 1525 Example

1500	1501	1502	1503	1504	1505
1505	1515	1525	MENU	* subsequent item on the menu depends on instrument equipment	

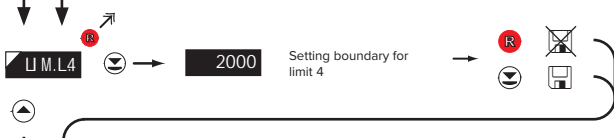

U M.L.4 Setting boundary for limit 4

- range of the setting: -99999...999999
- contingent modification of hysteresis or delay may be performed in "PROFI" menu

DEF = 2000
DEF „Hysteresis“=0, „Delay“=0

Setting limit 4 > LIM. L.4 = 2123 Example

2000	2001	2002	2003	2003	2013
2023	2023	2123	MENU	* subsequent item on the menu depends on instrument equipment	

5. SETTING LIGHT

DISPLAYED ONLY WITH OPTIONS > ANALOG OUTPUT

TYP.A.O. Setting the type of analog output

Menu	Range	Description
0..20mA	0..20 mA	
Er4..T	4..20 mA	with error message indication and broken loop indication (<3.6 mA)
4..20T	4..20 mA	with broken loop indication (<3.6 mA)
Er4..20	4..20 mA	with indication of error statement (<3.6 mA)
4..20mA	4..20 mA	
0..5mA	0..5 mA	
0..2 V	0..2 V	
0..5 V	0..5 V	
0..10 V	0..10 V	
+10 V	±10 V	

DEF = 4...20 mA

Type of analog output - 0..10 V > TYP.A.O. = U 10 Example

4..20mA 0..5mA 0..2 V 0..5 V 0..10 V MIN.A.O.

MIN.A.O. Assigning the display value to the beginning of the AO range

0

- range of the setting: -99999...999999 **DEF** = 0

Display value for the beginning of the AO range > MIN.A.O. = 0 Example

MAX.A.O.

!

As a default setting, analog output are active for the counter input "COUNT".
To change the input type to which the limits will be responding change the setting in item "RE.SET." or by switching into "PROFIMenu" in item "INP.A.O"

!

Items for "Limits" and "Analog output" are accessible only if incorporated in the instrument

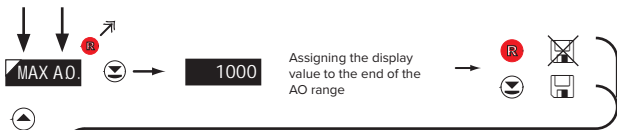

MAX A.O. Assigning the display value to the end of the AO range

- range of the setting: -99999...999999

DEF = 1000

Display value for the end of the AO range > MAX A.O. = 1020 Example

1000 ◀ 1000 ▶ 1010 ▶ 1020 ▼ MENU

DISPLAYED ONLY WITH OPTIONS > ANALOG OUTPUT

5. SETTING LIGHT

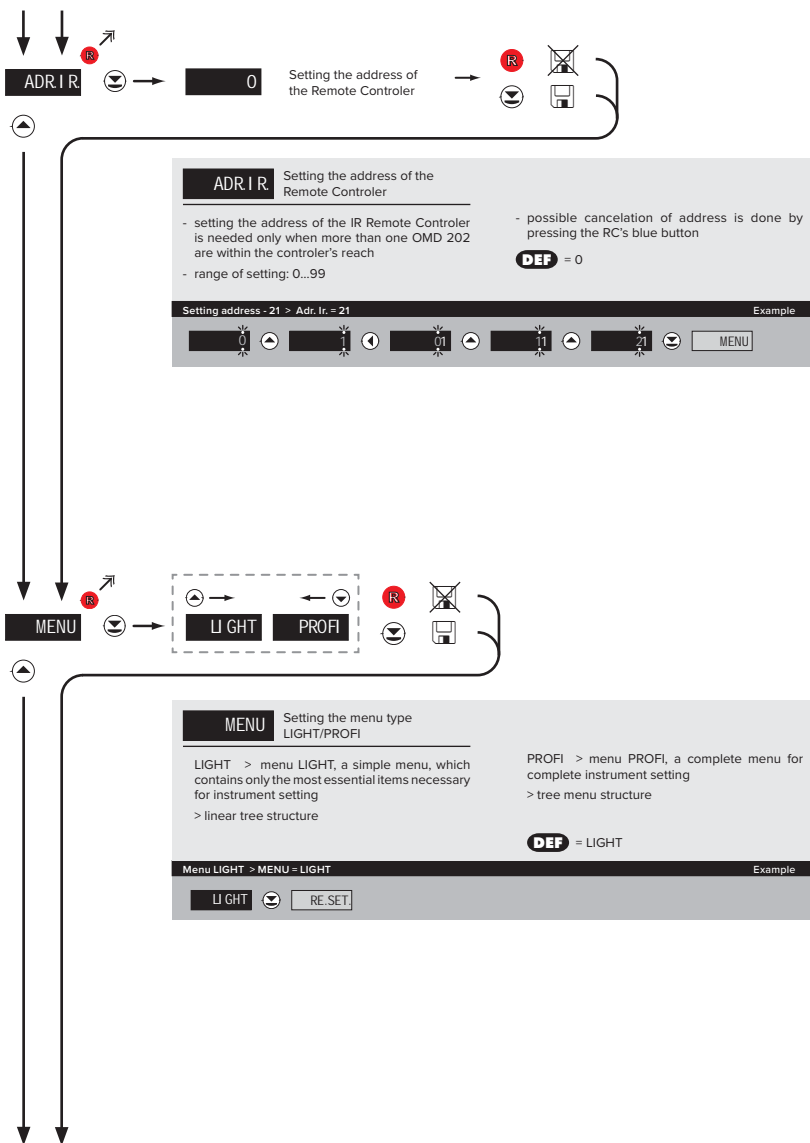

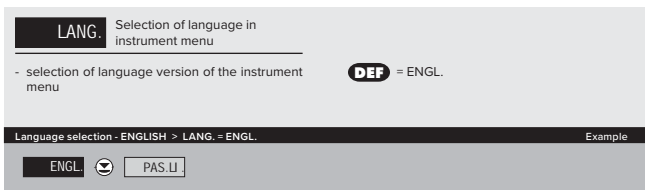
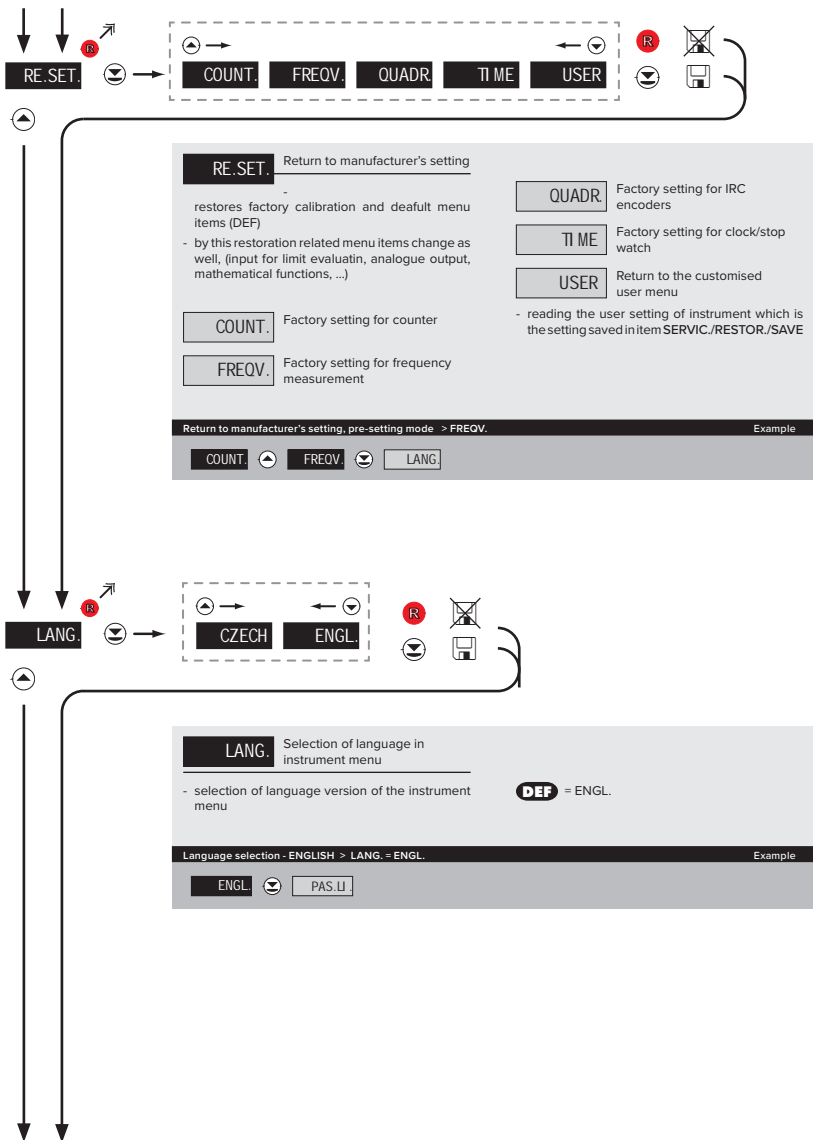

5. SETTING LIGHT

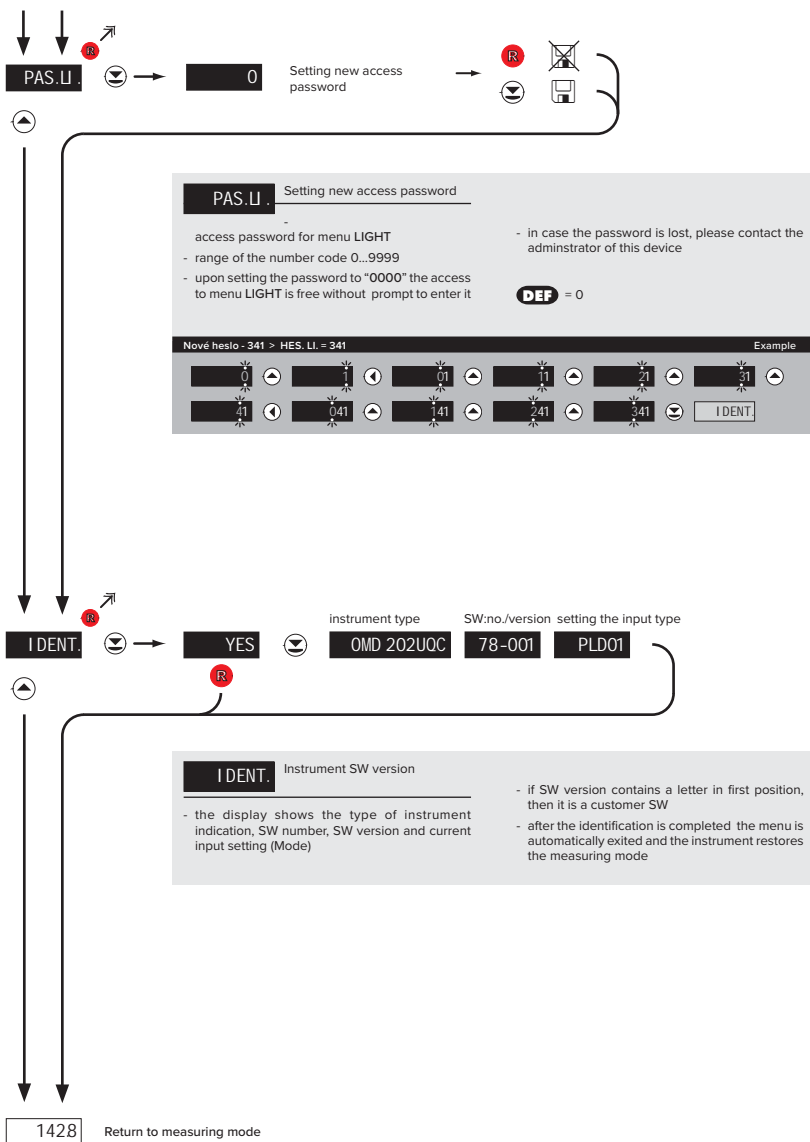



SETTING LIGHT 5.

SETTING PROFI

For expert users

Complete instrument menu

Access is password protected

Possibility to arrange items of the USER MENU

Tree menu structure

6.0 SETTING "PROFI"

PROFI

Complete programming menu

- contains complete instrument menu and is protected by optional number code
- designed for expert users
- preset from manufacture is menu LIGHT

Switching over to "PROFI" menu

>3 s



- access to PROFI menu
- authorization for access to PROFI menu does not depend on setting under item SERVIC. > MENU
- password protected access (unless set as follows under the item SERVIC. > N. PASS. > PROFI =0)



- access to menu selected under item SERVIC. > MENU > PROFI
- password protected access (unless set as follows under the item SERVIC. > N. PASS. > LIGHT =0)
- for access to LIGHT menu passwords for LIGHT and PROFI menu may be used



6. SETTING PROFI

6.1 SETTING "PROFI" - INPUTS

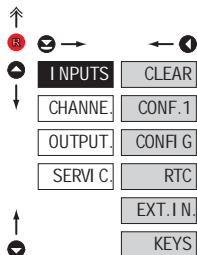

The primary instrument parameters are set in this menu

CLEAR	Resetting internal values
CONF. 1	Selection of measuring range and parameters Channel 1
CONF. G	Setting switching of channels
RTC	Setting date and time for option with RTC
EXT. I. N.	Setting external inputs functions
KEYS	Assigning further functions to keys on the instrument

6.1.1 RESETTING INTERNAL VALUES

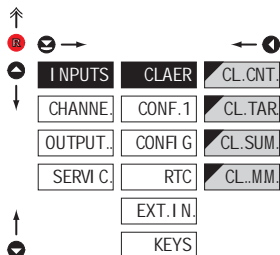

CLEAR	Resetting internal values to zero
CL. CNT.	Counter resetting - when zeroed, the figure on the display will be added to the total sum („grand total“), a value which is stored in the instrument's internal memory
CL. TAR.	Tare resetting
CL. SUM.	Zeroing of the sum - summation is used for cummulated values (i.e. factory shifts) when values from individual shifts are added to the total sum
CL. MM.	Zeroing of min/max value - zeroes the memory used to store minimal and maximal values

6.1.2 INSTRUMENT CONFIGURATION - CHANNEL 1

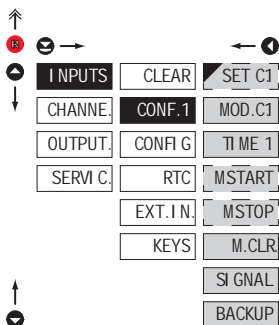

CONF. 1 Primary instrument setting

- SET C1** Setting the initial value
- MOD. C1 Setting the instrument measuring mode
- TI ME 1 Setting the time base
- MSTART Setting the stopwatch control
- M. STOP Setting stopwatch resetting
- M. CLR Setting the zeroing of the instrument
- SI GNAL Setting input parameters
- BACKUP Setting data backup/time

6.1.2a SETTING THE INNITIAL DISPLAYED VALUE

C H

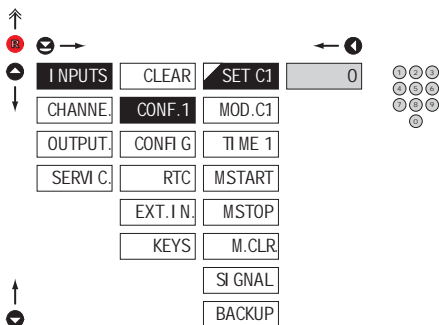

SET C1 Setting initial displayed value

- used to set the displayed value to desired initial value (useful when exchanging instruments yet still keeping the original value)

6. SETTING PROFI

6.1.2b

SELECTION OF MEASURING MODE

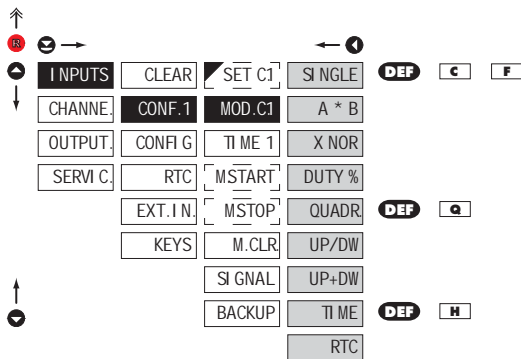

MOD.C1

Selection of instrument measuring mode

SINGLE

Impulse counter/Frequency measurement

A * B

Impulse counter/Frequency meter with function „AND“

- instrument works with the following condition:

A	0	0	1	1
B	0	1	0	1
OUT	0	0	0	1

XNOR

Impulse counter/Frequency meter with function „xNOR“

- instrument works with the following condition:

A	0	0	1	1
B	0	1	0	1
OUT	1	1	0	0

DUTY %

Duty cycle

- the maximum frequency duty cycle measurement is 100 kHz

QUADR.

Impulse counter/Frequency measurement for IRC

encoders

- measurement on two inputs (A & B). Can display count and frequency

- in this mode every single rising edge of signal A and B is included in the count

UP/DW

UP/DW Impulse counter/ Frequency meter

- measurement on input A, (inp. B/direction). Can display count and frequency

UP+DW

UP+DW Impulse counter/ Frequency meter

- measures on inputs A (UP), B (DW). Can display count and frequency

TI ME

Mode „Stopwatch/timer“

RTC

Mode „Stopwatch/timer“ with RTC backup



6.1.2c SELECTION OF MEASURING PERIOD/TIME BASE

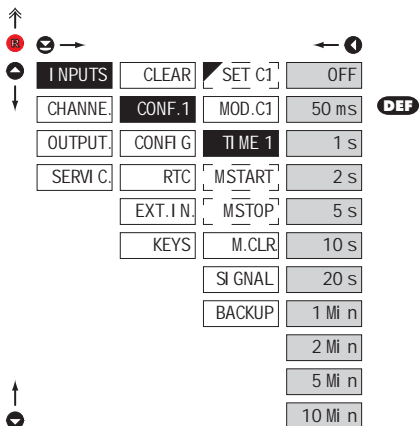

TIME 1 Selection of measuring period/time base

- if you set measuring period e.g. for 1 s, the measuring runs approximately from 1 s to 2 s (1 s + maximum one cycle of measured signal). If no signal arrives within 2 s it is taken that the signal has zero frequency
- range of setting of the time base is 0,5 s to 10 min.
- in the „RTC“ regime with data projection the set time defines the cycle of switching between time (min. is 5 s), date (cca 2,5 s)

!

Attention! When setting the division constant in the range of 2...255, and when we measure using an exact no. of incoming pulses we need to ensure that an integer no. of pulses arrive, otherwise the frequency is declared as ZERO!

For mode "TIME" the time base is 29 MHz, for mode "RTC" it is 1 s

6. SETTING PROFI

6.1.2d

SELECTION OF STOPWATCH/TIMER CONTROL

H

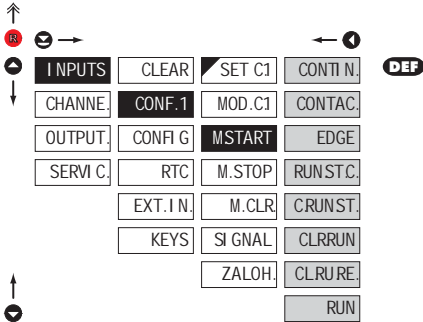

M.START

Selection of stopwatch/ timer control

- time setting menu is accessible only in the stopwatch/timer regime
- setting applies only to Input „A“

CONTI N.

Stopwatch/timer is running constantly if the instrument is turned on

CONTAC.

Stopwatch/timer is running upon contact making

EDGE

Stopwatch/timer is controlled by the priming signal edge

- time is set off by the edge (by the signal passing across the comparing level) and stopped by the next edge

RUNSTC.

Stopwatch/timer is controlled and reset by the edge of the priming signal

- time is set off by the edge (by the signal passing across the comparing level) and stopped by the next edge

CRUNST.

Stopwatch/timer is controlled and reset by the edge of the priming signal

- time is set off by the edge (by the signal passing across the comparing level) and stopped by the next edge

CLRRUN

Stopwatch/timer is reset and set off by the edge of the priming signal (when the time is not running)

CLRURE.

Stopwatch/timer is reset and set off by the edge of the priming signal, the cycle is repeated with every other edge (when the time is running)

RUN

Stopwatch/timer is only set off by the edge

6.1.2e SELECTION OF STOPWATCH/TIMER RESETTING

H

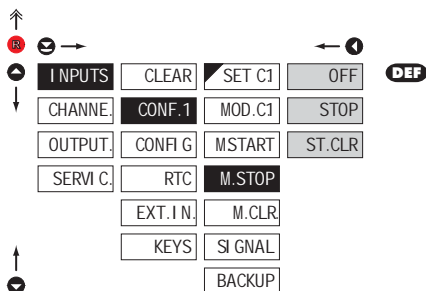
**M.STOP** Selection of stopwatch resetting

- menu of the resetting option is accessible only in the stopwatch/timer regime
- setting applies only to Input „B“

OFF	Zeroing by external input is switched off
STOP	Stopwatch/timer is stopped through input „Clear“
ST.CLR	Stopwatch/timer is stopped and reset through input „Clear“

6.1.2f SELECTION OF ZEROING

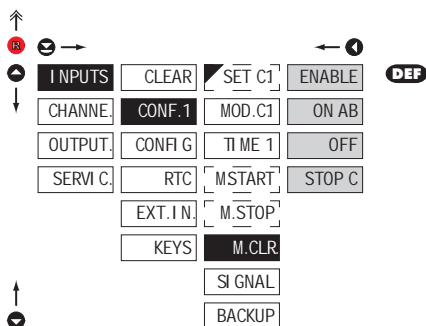
**M.CLR** Selection of zeroing

- setting of external zeroing input „C“

ENABLE	„Zeroing“ is permitted
ON AB	„Zeroing“ is permitted
OFF	„Zeroing“ is switched off
STOP C	Stop watch/clock is stopped by input „Zeroing“

6.1.2i SELECTION OF ACTIVE LEVEL OR EDGE FOR INPUT B

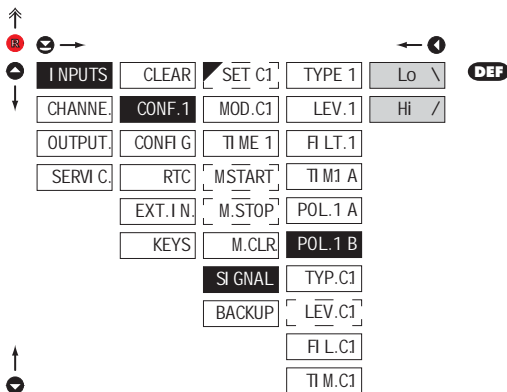

POL.1 b Selection of active level or edge

**Lo ** Active upon change of entering edge Hi > Lo

- upon entering the contact>active on switch-on

Hi / Active upon change of declining edge Lo >Hi

- upon entering the contact>active on switch-off

6.1.2m SELECTION OF THE TYPE OF INPUT FOR INPUT C

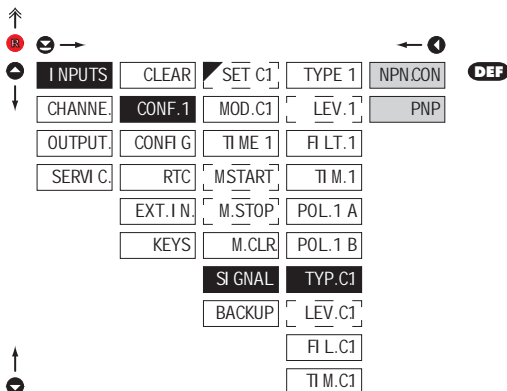

TYP.C1 Selection of type of input

- setting applies for Input C

NPN.CON Type of input NPN and upon contact

PNP Type of input PNP

!
With selection of "PNP" it is necessary to set the input level (LEV. C.1)

6. SETTING PROFI

Programming sch

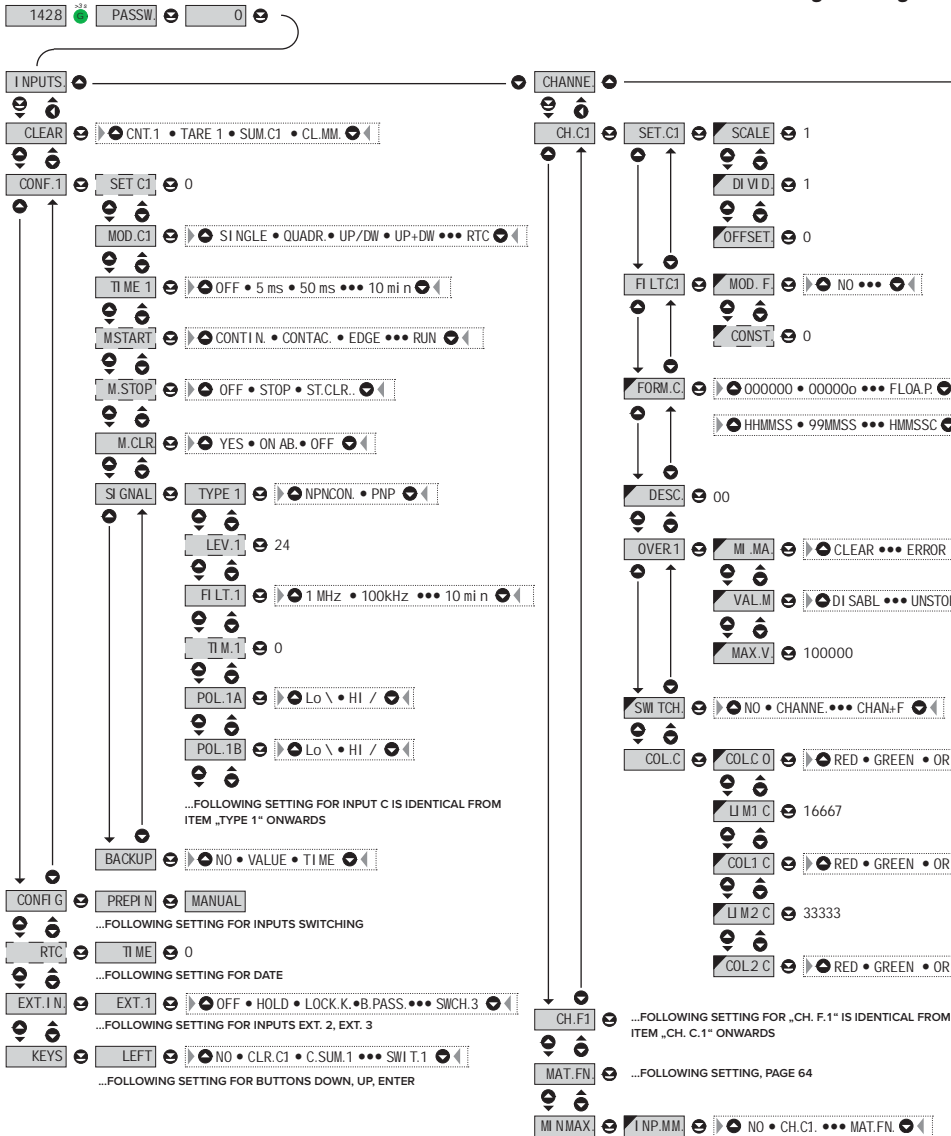

PROFI MENU

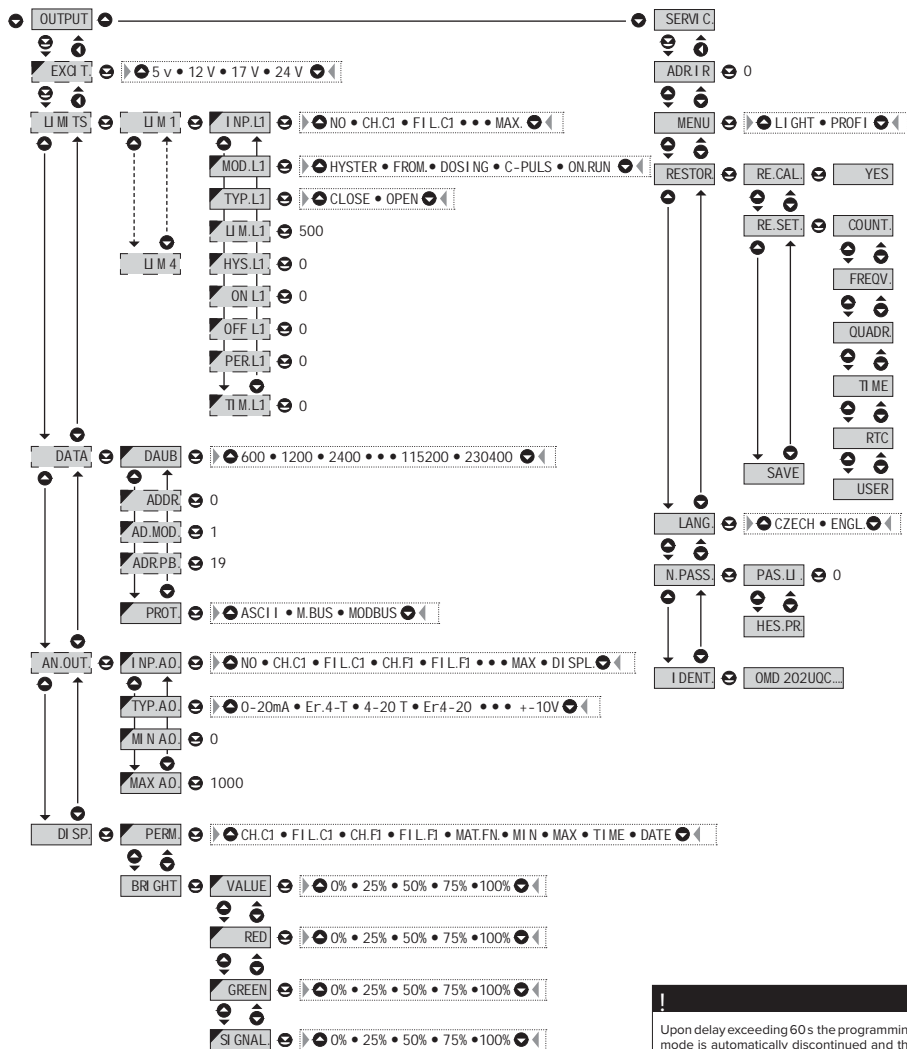

! Upon delay exceeding 60 s the programming mode is automatically discontinued and the instrument itself restores the measuring mode

6.1.2p SETTING THE BLOCKING FOR INPUT C

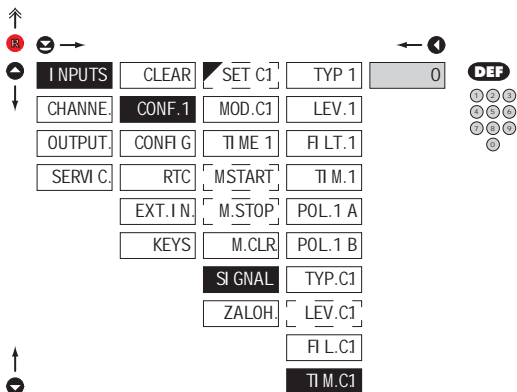

TI M.1 Setting the input blocking

- setting applies to input C
- setting the time period when no incoming input signals are counted
- range of setting 0...120 s

6.1.2q SETTING THE DISPLAY STATUS BACKUP

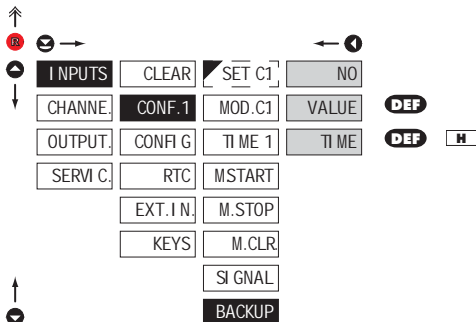

BACKUP Selection of display status backup

- time setting menu is accessible only in the stopwatch/timer regime
- setting display value restoration after power failure or instrument switch-off

NO Instrument resets itself after every switch-on

VALUE After switch-on the instrument loads the display status from the memory

TI ME Instrument downloads „running“ time from RTC

6. SETTING PROFI

6.1.3a SELECTION OF INPUTS SWITCHING

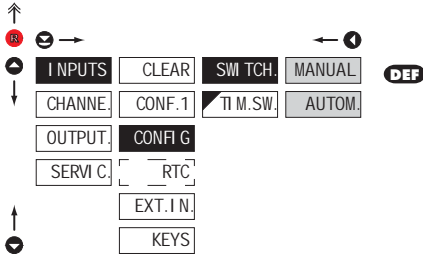

SWI TCH. Selection of inputs switching

MANUAL Manual inputs switching

- inputs switching is controlled by selected key on the front panel or selected external input

AUTOM. Measuring on selected channel

- inputs switching is automatic in a time period set in "TIM. SW."

6.1.3b SETTING THE PERIOD FOR INPUTS SWITCHING

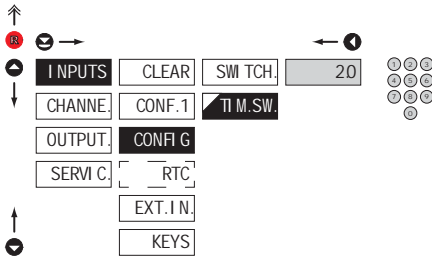

TIM. SW. Setting the period for inputs switching

- setting the time period for projection of channels in automatic mode of inputs switching ("AUTOM.")
- range of setting: 0.5...99.9 s (step 0.5 s)
- **DEF** TIM. SW. = 2 s

6.1.4 SETTING THE REAL TIME CLOCK

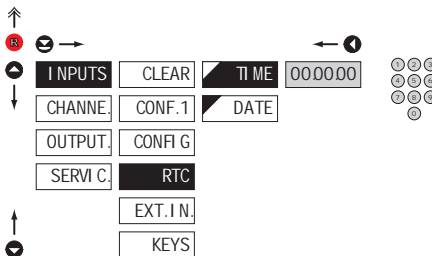

RTC Setting the real time clock (RTC)

TIME Time setting

- format 23.59.59

DATE Date setting

- format DD.MM.YY

6.1.5a EXTERNAL INPUT FUNCTION SELECTION

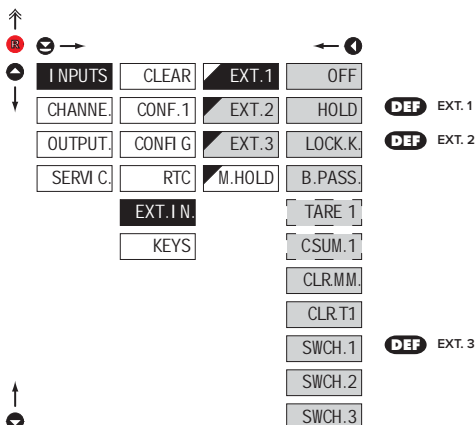

! Response to change of input is approx. 100ms

External inputs table

Function	Ext 1	Ext 2	Ext 3
Channel - counter	0	0	
Channel - frequency	0	1	
MF	0	0	1
Min	0	1	1
Max	1	0	1
Max	1	1	1

EXT.1 N. External input function selection

OFF Input is off

HOLD Activation of HOLD

- input activates function HOLD, which blocks all functions of the instrument

LOCK.K. Locking keys on the instrument

- active input disables all buttons to IR remote control

TARE 1 Tare activation

- input activates function TARE, only in mode "Frequency"

SUMA 1 External input controls function „Sum“

- active input displays the cumulated value of counter

N.SUM1 External input controls function „Zeroing of sum“

- active input zeroes (clears) the cumulated value of counter

CLRMM. Resetting min/max value

CLRT1 Tare resetting

SWCH.1 Successive switching of channel projection

SWCH.2 BCD switching of channel projection - EXT. 1, 2

- for operation see the table

- following this choice the setting for "EXT. 2" is automatically restricted

SWCH.3 BCD switching of channel projection - EXT. 1, 2, 3

- for operation see the table

- following this choice the setting for "EXT.2" and "EXT. 3" is automatically restricted

- DEF EXT. 1 > HOLD

- DEF EXT. 2 > LOCK. K.

- DEF EXT. 3 > SWCH. 1

*

Procedure identical for EXT. 2 and EXT. 3.

6. SETTING PROFI

6.1.5b

SELECTION OF FUNCTION "HOLD"

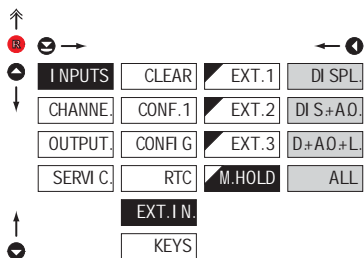

M.HOLD

Selection of function
"HOLD"

DI SPL.

"HOLD" locks only the value displayed

DI S+A.O.

"HOLD" locks the value displayed and on AO

D+A.O.+L.

"HOLD" locks the value displayed, on AO and limit evaluation

ALL

"HOLD" locks the entire instrument

6.1.6a OPTIONAL ACCESSORY FUNCTIONS OF THE KEYS

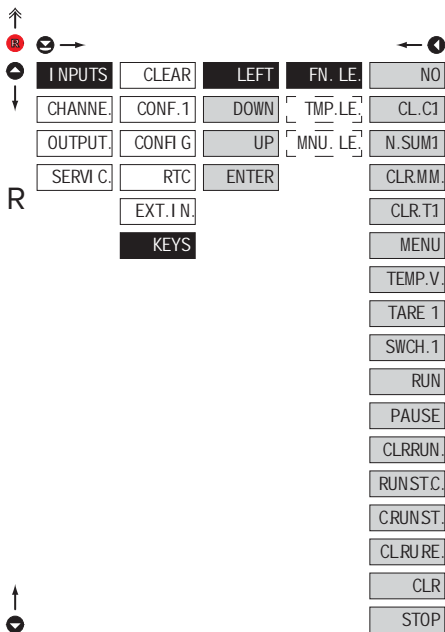

FN. LE. Assigning further functions to instrument keys

- „FN. LE.“ > executive functions

- NO** Key has no further function
- CL. C1** Aux. input controls the „CLEAR“ function
- input zeroes (presets) the counter
- N. SUM1** Clearing of Sum
- input zeroes the cumulated value of the counter
- CLR. MM** Resetting min/max value
- CLR. T1** Tare resetting
- MENU** Direct access to the selected item in the menu
- when this choice is made the item „MENU“ is displayed, and desired further selection can be made
- TEMP. V.** Temporary projection of selected values
- when this choice is made the item „TMP. LE.“ is displayed, and desired further selection can be made
- TARE 1** Activation of Tare function
- SWI T. 1** Continuous switching of projected channels
- RUN** Activation function „RUN“
- PAUSE** Activation function „PAUSE“
- CLRRUN** Stopky/hodiny se hranou spouštěcího signálu vynulují a spustí
- other items are related only to stopwatch control (detail description on p. 38/39)

Setting is identical for LEFT, DOWN, UP and ENTER

Only the channel which is permanently projected is active

!
Functions of button PAUSE
- displays the latest projected value until the next push of the button - dots/dot signals stop watch running by flashing

!
Preset button functions **DEF**:

	COUNTER	FREQUEN.	QVADRAT.	WATCH
LEFT	Sum C. 1	C. 1	F. 1	Start
UP	MAX C. 1	MAX F. 1	MAX F. 1	Clear
DOWN	CLR. MAX	MIN F. 1	CLR. M.M.	Pause
ENTER	Clear	CLR. M.M.	Clear	Stop

6.1.5c OPTIONAL ACCESSORY FUNCTIONS OF THE KEYS - DIRECT ACCESS TO ITEM

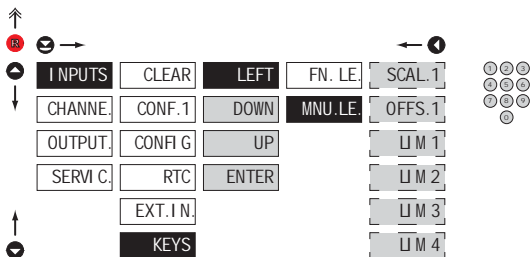

MNU. LE. Assigning access to selected menu item

- „MNU. LE.“ > direct access into menu on selected item

SCAL. 1 Direct access to item "SCALE"

OFFS. 1 Direct access to item "OFFSET"

LIM 1 Direct access to item "LIM 1"

LIM 2 Direct access to item "LIM 2"

LIM 3 Direct access to item "LIM 3"

LIM 4 Direct access to item "LIM 4"

!
Setting is identical for LEFT, DOWN, UP and ENTER

6. SETTING PROFI

6.2 SETTING "PROFI" - CHANNEL

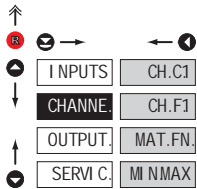

In this menu the instrument input parameters are set

CH.C1	Setting parameters of measuring "Channel 1" - Counter
CH.F1	Setting parameters of measuring "Channel 1" - Frequency/Watch
MAT.FN.	Setting parameters of mathematic functions
MI NMAX	Selection of access and evaluation of Min/max value

6.2.1a SETTING MULTIPLYING CONSTANT - CHANNEL COUNTER

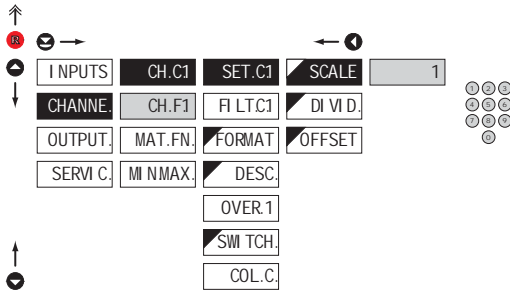

SCALE Setting multiplying constant

multiplying constant serves for calculation of input value to required display value

- by entering minus value the direction of calculation is changed, i.e. we count down
- range: -99999...999999

- DEF = 1

! Setting is identical for "CH. F.1"

! H

If non-zero value is set in the "TIME" or "RTC" mode in the "OFFSET" item, it applies that the multiplying constant "SCALE" is negative

6.2.1b SETTING DIVISION CONSTANT - CHANNEL COUNTER

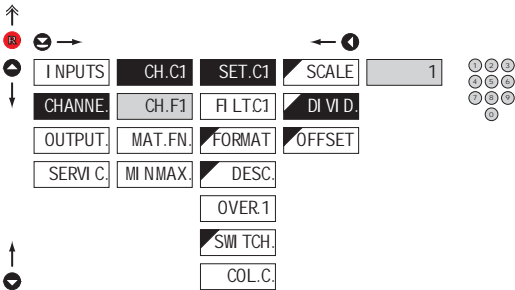
**DI V I D.** Setting division constant
Channel - Counter

- division constant serves for calculation of input value to required display value
- range: -99999...999999

- **DEF** = 1

! Setting is identical for "CH. F.1"

*
Revolution measurement function

If you set the division constant (invariable) for channel F1 (F2) as an integer number (range 2...255), the measurement will be realised according to the preset multiplications of revolutions/pulses. In reality this means that revolutions are measured precisely after a number of revolutions have been fully completed, which results in an improved stability of the measured value. This mode is not suitable for higher frequencies, where it can increase the measurement period. If you do not wish to use this mode, multiply both the multiplication and division constant by 10, 100 or 0.5 so that the resulting number is not integer or within the 2...255 range. Please pay attention to the time platform (TIME 1), which must allow for adding up the 2...255 pulses within the set time period. ATTNI When this option is used in the QUADR mode, it may result in an error when the direction of revolution is reversed.

6.2.1c SETTING ADDITIVE CONSTANT - PRESET, CHANNEL COUNTER

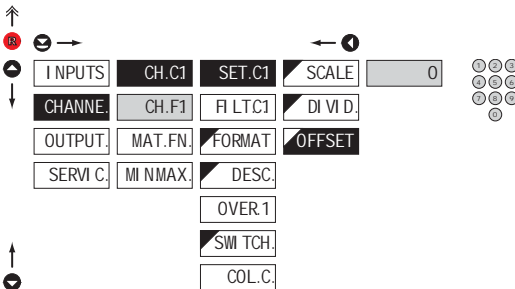
**OFFSET** Setting PRESET constant
Channel - Counter

- offset of the measuring by a set value, which shall be loaded always upon instrument resetting
- range: -99999...999999

- **DEF** = 0

! Setting is identical for "CH. F.1"

6. SETTING PROFI

6.2.1d SETTING DIGITAL FILTERS - CHANNEL COUNTER

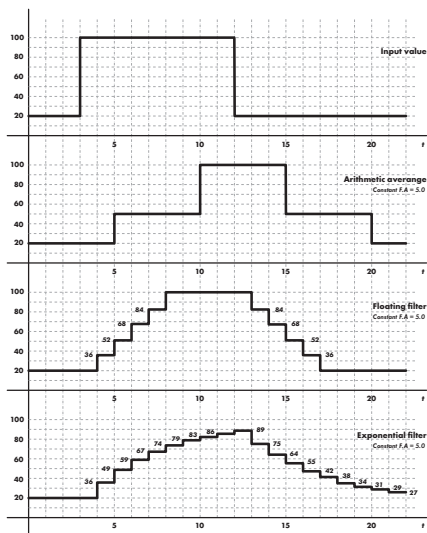
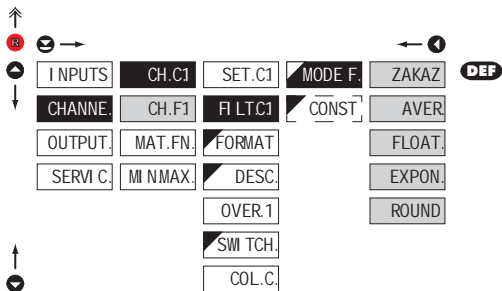

MODE F.

Selection of digital filters

- at times it is useful for better user projection of data on display to modify it mathematically and properly, wherefore the following filters may be used:

NO Filters are off

AVER Measured data average*

- arithmetic average from given number („CONST.“) of measured values
- range 2...100

FLOAT. Selection of floating filter*

- floating arithmetic average from given number („CONST.“) of measured data and updates with each measured value
- range 2...30

EXPON. Selection of exponential filter*

- integration filter of first prvnho grade with time constant („CONST.“) measurement
- range 2...100

ROUND Measured value rounding

- is entered by any number, which determines the projection step (e.g. "CONST."=2,5 > display 0, 2,5, 5,...)

CONST. Setting constants

- this menu item is always displayed after selection of particular type of filter

DEF = 2

!
Setting is identical for "CH. F.1"

*only for mode Frequency/Duty Cycle

6.2.1e PROJECTION FORMAT - POSITIONING OF DECIMAL POINT

↑

Ⓡ →

← Ⓛ

I INPUTS	CH. C1	SET. C1	000000	DEF	C
CHANNE.	CH. F1	FI LTC1	00000.0	DEF	F
OUTPUT.	MAT. FN.	FORMAT	0000.00		
SERV. C.	MI NMAX.	DESC.	000.000		
	OVER.1		00.0000		
	SWI TCH.		0.00000		
	COL. C.	FLOAT. P.			
		HHMMSS		DEF	H
		99MMSS			
		HHHHMM			
		MMMMSS			
		MMSS.CC			
		99SS.CC			
		HMMSS.C			
		MSS.CCC			
		DHHMMS			
		DDHHMM			

↓

FORMAT Selection of decimal point

-

the instrument can project numbers in a standard way incl. the decimal point, time formats and also floating decimal point which ensures the most accurate value projection when „FLOA. P.“ is selected

Abbreviations

- "FLOA. P." > floating decimal point
- "D." > day
- "H." > hour
- "M." > minute
- "S." > second
- "C." > hundredth of a second

!

Setting is identical for "CH. F.1"

6.2.1f PROJECTION OF DESCRIPTION - THE MEASURING UNITS

↑

Ⓡ →

← Ⓛ

I INPUTS	CH. C1	SET. C1	00		
CHANNE.	CH. F1	FI LTC1			
OUTPUT.	MAT. FN.	FORMAT			
SERV. C.	MI NMAX.	DESC.			
	OVER.1				
	SWI TCH.				
	COL. C.				

↓

↑

Ⓛ

Ⓡ

Ⓢ

Ⓣ

Ⓤ

Ⓥ

Ⓦ

Ⓧ

Ⓨ

Ⓩ

DESC. Setting projection of description for "Channel A"

- projection of measured data may be extended (at the expense of the number of displayed places) by two characters for description
- description is set by shifted ASCII code, when two first places show the set description and two last characters their code in period 0...95
- description is cancelled by code 00
- **DEF** = 00 (no description)

!

Table of signs on page 89

6. SETTING PROFI

6.2.1g SETTING FUNCTIONS WHEN THERE IS DISPLAY/VALUE OVERFLOW

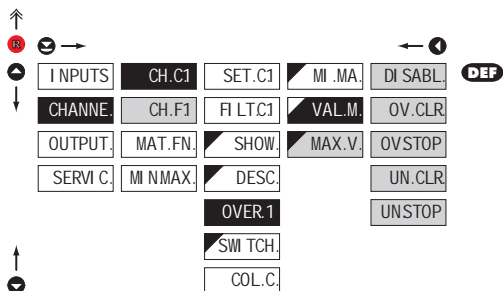
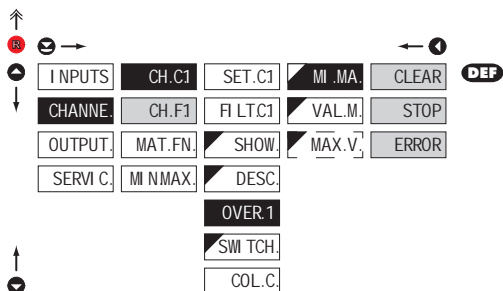

MI.MA. Setting the state of the instrument in the event of display overflow

- setting the state when there is an overflow/underflow of display
- can be used only for Chan. C.1

CLEAR The instrument zeroes itself and continues to count

STOP Measurement stops

- the display will continue to show the maximum or the minimum displayable value

ERROR Measurement stops

- display will show an error message „E. I.Un.“ or „E. I.Ov.“

VAL.M. Setting the state of the instrument in the event of value overflow

- setting the state when the instrument reaches a preset display value

DI.SABL. Function is disabled

OV.CLR. Counter clears itself over a certain value

OVSTOP Counter stops itself over a certain value

UN.CLR. Counter clears itself just under a certain value

UNSTOP Counter stops itself just under a certain value

MAX.V. Setting the limit value

- Setting the value when the counter performs function selected in menu "MAX.V."



Setting is identical for "CH. F.1"

6.2.1h SETTING THE CHANNEL PROJECTION IN SWITCH MODE

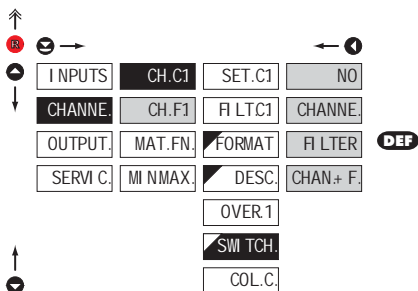

SWI TCH. Channel projection in switch mode

- this menu item allows the user to select individual measuring channels which will be displayed when switching amongst channels is active - function „SWITCH.“

NO	Switching is disabled
CHANNE.	„Channel 1“ will be displayed
FILTER	„Channel 1“ after being processed by digital filter will be displayed
CHAN+F.	„Channel 1“ will be displayed followed by „Channel 1“ after being processed by digital filter

!
Setting is identical for "CH. F.1"

6.2.1i SELECTION OF DISPLAY COLOR FOR CHANNEL COUNTER

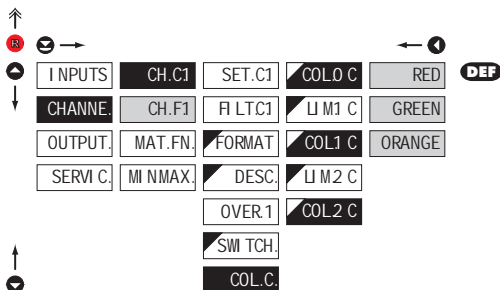

COL.C Selection of display color

- the color selection is governed by setting under items "LIM.1 C." and "LIM.2 C."

RED	Red color
GREEN	Green color
ORANGE	Orange color

- "COL.0 C" **DEF** = Green
- "COL.1 C" **DEF** = Orange
- "COL.2 C" **DEF** = Red

!
If the instrument is in the Hi Brightness LEDs execution, this menu item is not accessible

6. SETTING PROFI

6.2.1j SELECTION OF DISPLAY COLOR CHANGE FOR CHANNEL COUNTER

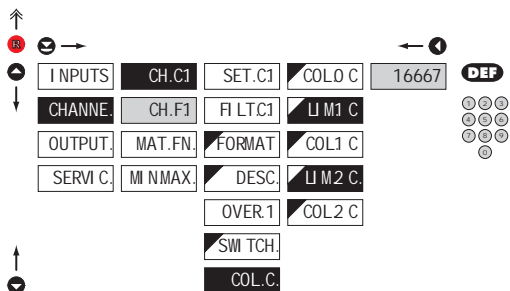

LI M1 C Selection of display color change

- under items "LIM.1 C" and "LIM.2 C" the limit is set for the time when the display color shall change

- "LIM.1 C" **DEF** = 16667

- "LIM.2 C" **DEF** = 33333



If the instrument is in the Hi Brightness LEDs execution, this menu item is not accessible

6.2.2a MATHEMATICAL FUNCTIONS - INPUT SELECTION

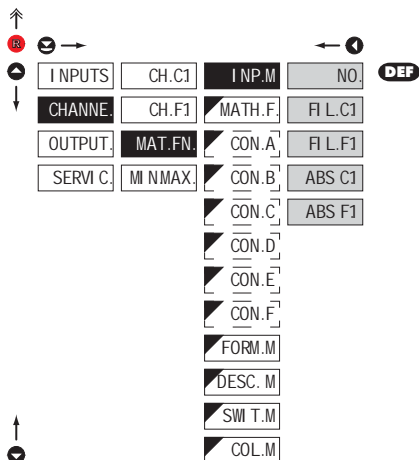

I NP.M Selecting the channel to be processed by mathematical function

- selecting the value from which the mathematical function will be calculated

NO Mathematical functions are off

FI L.C1 From channel 1 - counter after digital filter

FI L.F1 From channel 1 - frequen. after digital filter

ABS C1 The absolute value of the channel counter

ABS F1 The absolute value of the channel frequency

6. SETTING PROFI

6.2.3

SELECTION OF EVALUATION OF MIN/MAX VALUE

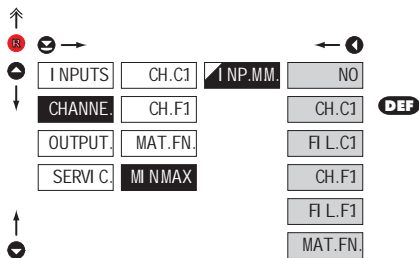

I NP.MM.

Selection of evaluation of min/max value

- selection of value from which the min/max value will be calculated

NO

Evaluation of min/max value is off

CH.C1

From "Channel 1" counter

FI L.C1

From "Channel 1" counter, after digital filters processing

CH.F1

From "Channel 1" frequency

FI L.F1

From "Channel 1" frequency, after digital filters processing

MAT.FN.

From "Mathematic functions"



6. SETTING PROFI

6.3 SETTING „PROFI“ - OUTPUTS

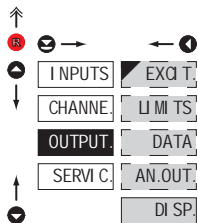

In this menu it is possible to set parameters of the instrument output signals

EXQ T.	Volba výstupního napětí pomocného zdroje
LIMITS	Setting type and parameters of limits
DATA	Setting type and parameters of data output
AN.OUT.	Setting type and parameters of analog output
DI.SP.	Setting display projection and brightness

6.3.1 SELECTION OF SENSOR EXCITATION VOLTAGE

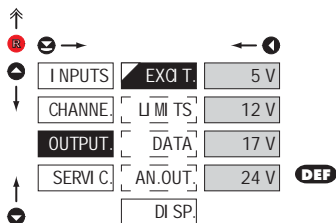

EXQ T.	Selection of sensor excitation voltage (aux. power supply)
5 V	5 VDC, max. 2,5 W
12 V	12 VDC, max. 2,5 W
17 V	17 VDC, max. 2,5 W
24 V	24 VDC, max. 2,5 W

6.3.2a SELECTION OF INPUT FOR LIMITS EVALUATION

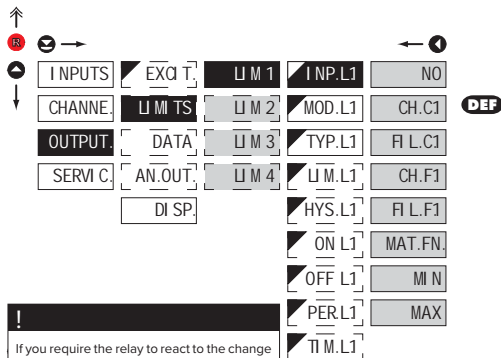

INP.L1	Selection evaluation of limits
NO	Limit evaluation is off
CH.C1	From "Channel 1" counter
FI.L.C1	From "Channel 1" counter, after digital filters processing
CH.F1	From "Channel 1" frequency
FI.L.F1	From "Channel 1" frequency, after digital filters processing
MAT.FN.	From "Mathematic functions"
MI.N.	From "Min. value"
MAX	From "Max. value"



If you require the relay to react to the change of the measured value immediately, select no filtration. This way the value is evaluated directly in the gate array.

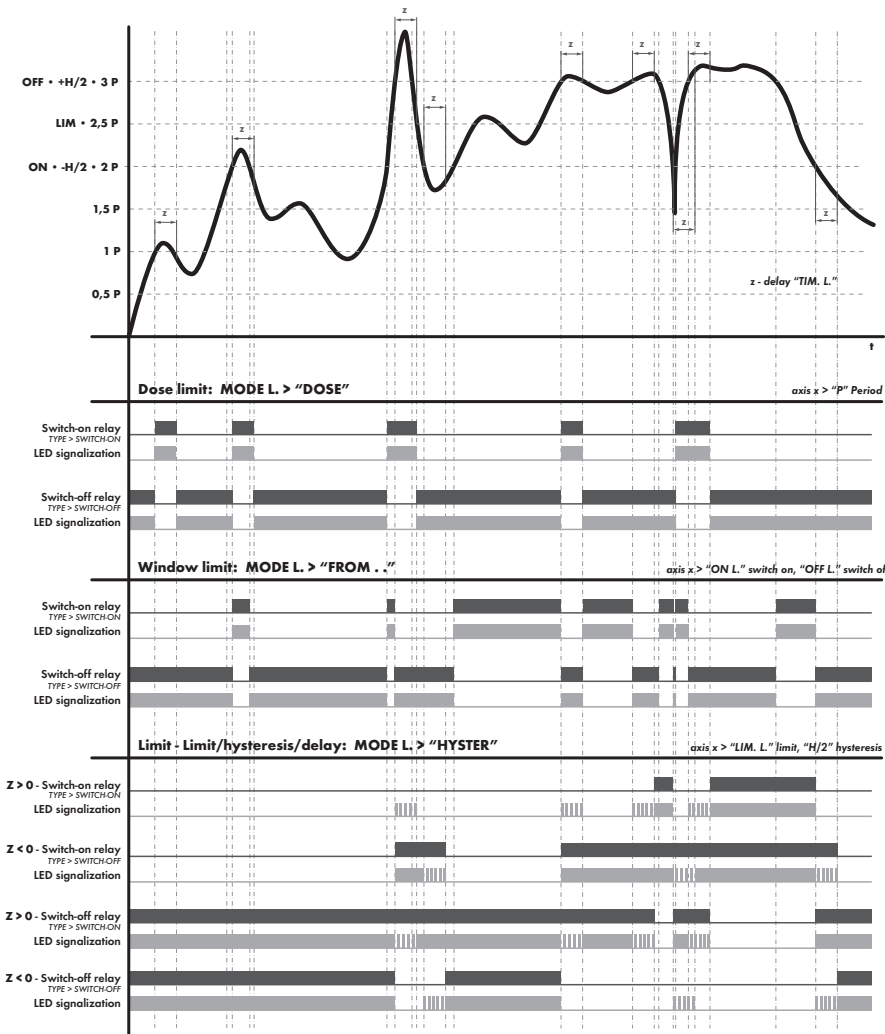

6. SETTING PROFI

6.3.2b

SELECTION OF TYPE OF LIMIT

!
Dose limit puts a heavy burden on the μP and therefore we do not recommend using it at frequencies exceeding 25 kHz.

MOD.L1 Selection the type of limit

HYS TER Limit is in mode "Limit, hysteresis, delay"

- for this mode the parameters of "LIM.L1" are set, at which the limit will react, "HYS.L1" the hysteresis range around the limit (LIM $\pm 1/2$ HYS) and time "TIM.L1" determining the delay of relay switch-on

FROM.. Frame limit

- for this mode the parameters are set for interval "ON.L1" the relay switch-on and "OFF.L1" the relay switch-off

DOSI NG Dose limit (periodic)

- for this mode the parameters are set for "PER.L1" determining the limit value as well as its multiples at which the output is active and "TIM.L1" indicating the time during which is the output active

C.-PULS. Automatic zeroing of the counter at a preset value and a generating an impulse of duration set in "TIM.L1"

ON RUN Relay is closed/opened while the stopwatch is running

!
Setting is identical for LIM 1, LIM 2, LIM 3, and LIM 4

* only for "fast limits"

6.3.2c

SELECTION OF TYPE OF OUTPUT

TYP.L1 Selection of type of output

CLO SE Output switches on when condition is met

OPE N Output switches off when condition is met

!
Setting is identical for LIM 1, LIM 2, LIM 3, and LIM 4

6.3.2d SETTING VALUES FOR LIMITS EVALUATION

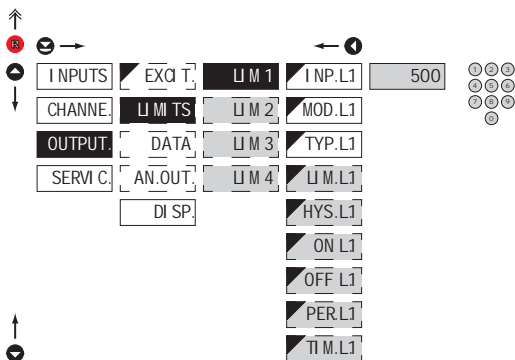

LIM.L1 Setting limit for switch-on

- for type "HYSTER"

HYS.L1 Setting hysteresis

- for type "HYSTER"

- indicates the range around the limit (in both directions, LIM. $\pm 1/2$ HYS.)

ON L1 Setting the outset of the interval of limit switch-on

- for type "FROM"

OFF L1 Setting the end of the interval of limit switch-on

- for type "FROM"

PER.L1 Setting the period of limit switch-on

- for type "DOSING"

TIM.L1 Setting the time switch-on of the limit

- for type "HYSTER", "DOSE" and „C-PULS"

- setting within the range: $\pm 0...99.9$ s

- positive time > relay switches on after crossing the limit (LIM. L.1) and the set time (TIM. L.1)

- negative time > relay switches off after crossing the limit (LIM. L.1) and the set negative time (TIM. L.1)

- in mode „DOSING" relay switches on at pre-set value (PER. L.1) and the duration of the switch-on (TIM. L.1) determines its next function. If the time is zero, then the state will change permanently (until next period), if the time is set for a non zero value, the switch-on will only last for the selected duration



Setting is identical for LIM 1, LIM 2, LIM 3, and LIM 4

6. SETTING PROFI

6.3.3a SELECTION OF DATA OUTPUT BAUD RATE

↑	←	BAUD	600	→	↓
↻	←	I NPUTS	EXQ T	ADDR	1200
↻	←	CHANNE	LI MI TS	AD. MOD	2400
↻	←	OUTPUT	DATA	ADR. PB	4800
↻	←	SERVI C	AN. OUT	PROT	9600
			DI SP		19200
					38400
					57600
					115200
					230400

DEF

BAUD	Selection of data output baud rate
600	600 Baud
1200	1 200 Baud
2400	2 400 Baud
4800	4 800 Baud
9600	9 600 Baud
19200	19 200 Baud
38400	38 400 Baud
57600	57 600 Baud
115200	115 200 Baud
230400	230 400 Baud

6.3.3b SETTING INSTRUMENT ADDRESS

↑	←	ADDR	00	→	↓
↻	←	I NPUTS	EXQ T	BAUD	00
↻	←	CHANNE	LI MI TS	ADDR	
↻	←	OUTPUT	DATA	AD. MOB	
↻	←	SERVI C	AN. OUT	ADR. PB	
↻	←		DI SP	PROT	

DEF

ADDR	Setting instrument address
-	setting in range: 0...31
- DEF	= 00
AD. MOB	Setting instrument address - MODBUS
-	setting in range: 1...247
- DEF	= 01
ADR. PB	Setting instrument address - PROFIBUS
-	setting in range: 1...127
- DEF	= 19

6.3.3c SELECTION OF DATA OUTPUT PROTOCOL

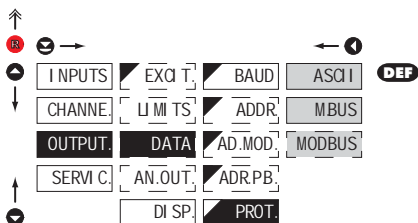

PROT. Selection of the type of analog output

ASCII Data protocol
ASCII

M.BUS Data protocol
DIN MessBus

MODBUS Data protocol
MODBUS-RTU

- option is available only for RS 485

6.3.4a SELECTION OF INPUT FOR ANALOG OUTPUT

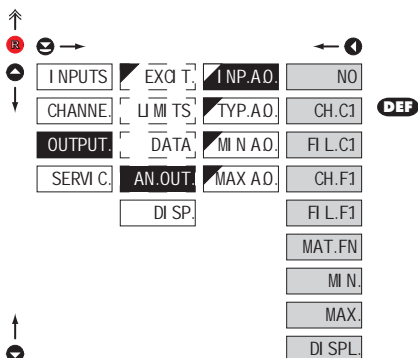

INP.A.O. Selection of source for analogue output

- selecting the value, on which the analogue output is based

NO Analogue output is off

CH.C1 From ch. 1 - counter

FI L.C1 From ch. 1 - counter after digital filter

CH.F1 From ch. 1 - frequency

FI L.F1 From ch. 1 - frequency after digital filter

MAT.FN. From "Mathematical function"

MI N. From "Min. value"

MAX. From "Max. value"

DI SPL. From "Permanently projected display value"

6. SETTING PROFI

6.3.4b SELECTION OF THE TYPE OF ANALOG OUTPUT

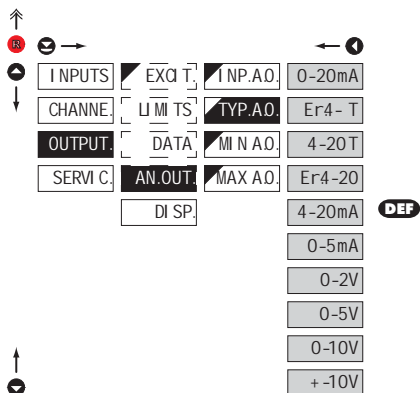

TYP.A.O.

Selection of the type of analog output

0-20mA Type: 0...20 mA

Er4-T Type: 4...20 mA with indication

- with broken loop detection and indication of error statement (< 3,6 mA)

4-20T Type: 4...20 mA with indication

- with broken loop detection (< 3,6 mA)

Er4-20 Type: 4...20 mA with indication

- with indic. of error statement (< 3,6 mA)

4-20mA Type: 4...20 mA

0-5mA Type: 0...5 mA

0-2V Type: 0...2 V

0-5V Type: 0...5 V

0-10V Type: 0...10 V

+10V Type: ±10 V

6.3.4c SETTING THE ANALOG OUTPUT RANGE

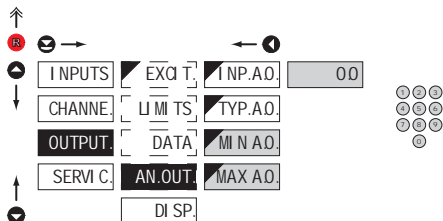

AN.OUT.

Setting the analog output range

- analog output is isolated and its value corresponds with displayed data. It is fully programmable, i.e. it allows to assign the AO limit points to two arbitrary points of the entire measuring range

MI N.A.O. Assigning the display value to the beginning of the

AO range

- setting in range: -99999...999999

- DEF = 0

MAX.A.O. Assigning the display value to the end of the AO range

- setting in range: -99999...999999

- DEF = 1000

6.3.5a SELECTION OF INPUT FOR DISPLAY PROJECTION

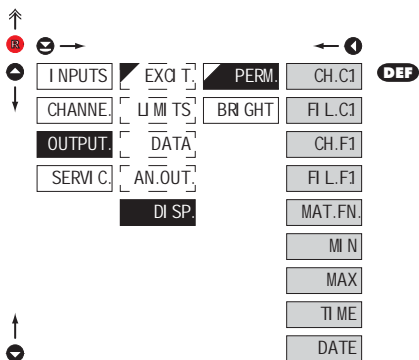
**PERM.** Selection display projection

-
selection of value which will be shown on the instrument display

CH.C1 Channel 1 - Counter

FI L.C1 Channel 1 - Counter, after digital filters processing

CH.F1 Channel 1 - Frequency

FI L.F1 Channel 1 - Frequency, after digital filters processing

MAT.FN. "Math. functions"

MIN "Min. value"

MAX. "Max. value"

TIME "Time"

DATE "Date"

- display switches between date/time in ratio of 2/13 s

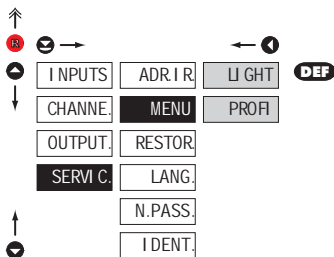

6.4.2 SELECTION OF TYPE OF PROGRAMMING MENU

**MENU** Selection of menu type - LIGHT/PROFI

- enables setting the menu complexity according to user needs and skills

U GHT Active LIGHT menu

- simple programming menu, contains only items necessary for configuration and instrument setting
- linear menu > items one after another

PROFI Active PROFI menu

- complete programming menu for expert users
- tree menu

! Change of setting is valid upon next access into menu

6.4.3 RESTORATION OF MANUFACTURE SETTING

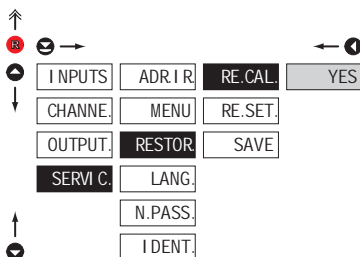
**RESTOR** Restoration of manufacture setting

- in the event of error setting or calibration, manufacture setting may be restored

RE.CAL. Restoration of manufacture calibration of the instrument

- prior executing the changes you will be asked to confirm you selection „YES“

6. SETTING PROFI

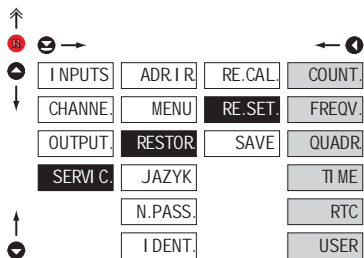

RE.SET.

Restoration of instrument manufacture setting

- reading of factory calibrations and default menu item setting (DEF)
- by selecting desired settings interconnected items change as well, (source for relay evaluation, analogue output, Mathematical functions, ...)

COUNT Manufacturer setting for counter

FREQV. Manufacturer setting for frequency

QUADR. Manufacturer setting for IRC encoders

TIME Manufacturer setting for clock/timer

RTC Manufacturer setting for RTC

USER Restoration of instrument user setting

- generating the instrument user setting, i.e. setting stored under SERVIC./RESTOR./SAVE

SAVE Save instrument user setting

storing the user setting allows the operator to restore it in future if needed

! After restoration the instrument switches off for couple seconds

JOBS PERFORMED	RESTORE	
	CALIBRATION	SETTING
cancels USER menu rights	✓	✓
deletes table of items order in USER - LIGHT menu	✓	✓
adds items from manufacture to LIGHT menu	✓	✓
deletes data stored in FLASH	✓	✓
cancels or linearization tables	✓	✓
clears tare	✓	✓
restore manufacture calibration	✓	✗
restore manufacture setting	✗	✓

6.4.4 SELECTION OF INSTRUMENT MENU LANGUAGE VERSION

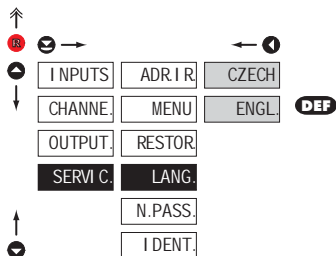

LANG. Selection of instrument menu language version

CZECH Instrument menu is in Czech

ENGL. Instrument menu is in English

6.4.5 SETTING NEW ACCESS PASSWORD

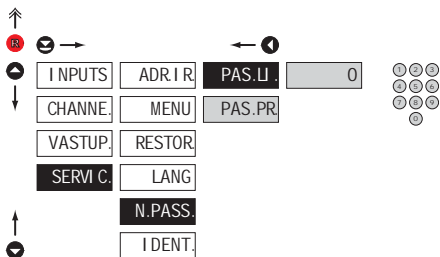

N.PASS. Setting new password for access to LIGHT and PROFi menu

- this option allows to change the numeric code, which blocks the access into LIGHT and PROFi menu.
- numercl code range: 0...9999
- universal passwords in the event of loss: LIGHT Menu > „8177“ PROFi Menu > „7915“

6.4.6 INSTRUMENT IDENTIFICATION

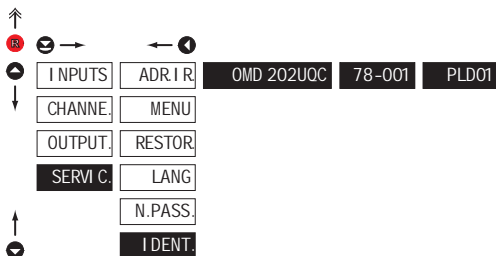

I DENT. Projection of instrument SW version

- display shows type identification of the instrument, SW number, SW version and current input setting (Mode)
- if the SW version reads a letter on first position, it is a customer SW

	Pos.	Description
I DENT.	1.	type of instrument
	2.	SW: number - version
	3.	the input type

SETTING USER

For user operation

Menu items are set by the user (Profi/Light) as per request

Access is not password protected

Optional menu structure either tree (PROFI) or linear (LIGHT)

7.0 SETTING ITEMS INTO "USER" MENU

- **USER** menu is designed for users who need to change only several items of the setting without the option to change the primary instrument setting (e.g. repeated change of limit setting)
- there are no items from manufacture permitted in **USER** menu
- on items indicated by inverse triangle  **UM 1**
- setting may be performed in **LIGHT** or **PROFI** menu, with the **USER** menu then overtaking the given menu structure

Setting

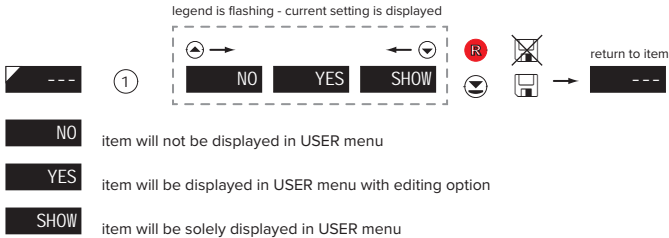

Setting sequence of items in "USER" menu

In compiling USER menu from active LIGHT menu the items (max. 10) may be assigned a sequence, in which they will be projected in the menu

setting projection sequence



Example of ranking the order of menu items in the "USER" menu

In this example we want to have a direct access to menu items Limit 1 and Limit 2 (example show is for the Light menu, but can equally be used in the Profi menu).

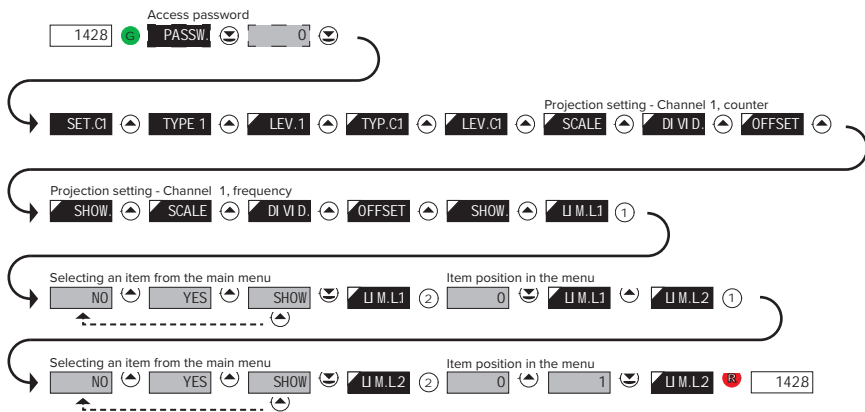

The result of this setting is that when the **15** button is pressed, the display will read „LIM. L.1“. By pressing **0** button you confirm your selection and then you can set the desired limit value, or by pressing the **0** button you can go to setting of „LIM. L.2“ where you can proceed identically as with Limit one.

You can exit the setting by pressing the **0** button by which you store the latest setting and pressing the **15** button will take you back to the measuring mode.

8. DATA PROTOCOL

The instruments communicate via serial line RS232 or RS485. For communication they use the ASCII protocol. Communication runs in the following format:

ASCII: 8 bit, no parity, one stop bit
 DIN MessBus: 7 bit, even parity, one stop bit

The transfer rate is adjustable in the instrument menu. The instrument address is set in the instrument menu in the range of 0 ÷ 31. The manufacture setting always presets the ASCII protocol, rate of 9600 Baud, address 00. The type of line used - RS232 / RS485 - is determined by an output board automatically identified by the instrument.

The commands are described in specifications you can find at www.orbit.merret.cz

DETAILED DESCRIPTION OF COMMUNICATION VIA SERIAL LINE

EVENT	TYPE	PROTOCOL	TRANSMITTED DATA	
Data solicitation (PC)	232	ASCII	# A A <CR>	
		MessBus	No - data is transmitted permanently	
	485	ASCII	# A A <CR>	
		MessBus	<SADR> <ENQ>	
Data transmission (instrument)	232	ASCII	> D (D) (D) (D) (D) (D) (D) (D) (D) (D) (D) <CR>	
		MessBus	<STX> D (D) (D) (D) (D) (D) (D) (D) (D) (D) (D) <ETX> <BCC>	
	485	ASCII	> D (D) (D) (D) (D) (D) (D) (D) (D) (D) (D) <CR>	
		MessBus	<STX> D (D) (D) (D) (D) (D) (D) (D) (D) (D) (D) <ETX> <BCC>	
Confirmation of data acceptance (PC) - OK	485	MessBus	<DLE> 1	
Confirmation of data acceptance (PC) - Bad			<NAK>	
Sending address (PC) prior command			<EADR> <ENQ>	
Confirmation of address (instrument)			<SADR> <ENQ>	
Command transmission (PC)	232	ASCII	# A A N P (D) (D) (D) (D) (D) (D) (D) <CR>	
		MessBus	<STX> \$ N P (D) (D) (D) (D) (D) (D) (D) <ETX> <BCC>	
	485	ASCII	# A A N P (D) (D) (D) (D) (D) (D) (D) <CR>	
		MessBus	<STX> \$ N P (D) (D) (D) (D) (D) (D) (D) <ETX> <BCC>	
Command confirmation (instrument)	232	ASCII	OK ! A A <CR>	
			Bad ? A A <CR>	
		Messbus		No - data is transmitted permanently
		485	ASCII	OK ! A A <CR>
	Bad ? A A <CR>			
	MessBus		OK <DLE> 1	
			Bad <NAK>	
	Instrument identification			# A A 1 Y <CR>
HW identification			# A A 1 Z <CR>	
One-time transmission			# A A 7 X <CR>	
Repeated transmission			# A A 8 X <CR>	

LEGEND

SIGN	RANGE		DESCRIPTION
#	35	23 _H	Command beginning
A	A	0...31	Two characters of instrument address (sent in ASCII - tens and units, e.g. "01", "99" universal)
<CR>	13	0D _H	Carriage return
<SP>	32	20 _H	Space
C, P			Number and command - command code
D			Data - usually characters "0"... "9", "-", ".", ";", "(", ")", "dp", and "(" may prolong data
R	30 _H ...3F _H		Relay and tare status
!	33	21 _H	Positive confirmation of command (ok)
?	63	3F _H	Negative confirmation of command (point)
>	62	3E _H	Beginning of transmitted data
<STX>	2	02 _H	Beginning of text
<ETX>	3	03 _H	End of text
<SADR>	adresa +60 _H		Prompt to send from address
<EADR>	adresa +40 _H		Prompt to accept command at address
<ENQ>	5	05 _H	Terminate address
<DLE>1	16 49	10 _H 31 _H	Confirm correct statement
<NAK>	21	15 _H	Confirm error statement
<BCC>			Check sum -XOR

RELAY, TARE

SIGN	RELAY 1	RELAY 2	TARE	CHANGE RELAY 3/4
P	0	0	0	0
Q	1	0	0	0
R	0	1	0	0
S	1	1	0	0
T	0	0	1	0
U	1	0	1	0
V	0	1	1	0
W	1	1	1	0
p	0	0	0	1
q	1	0	0	1
r	0	1	0	1
s	1	1	0	1
t	0	0	1	1
u	1	0	1	1
v	0	1	1	1
w	1	1	1	1

Relay status is generated by command #AA6X <CR>.

The instrument immediately returns the value in the format >HH <CR>, where HH is value in HEX format and range 00_H...FF_H. The lowest bit stands for „Relay 1“, the highest for „Relay 8“

9. ERROR STATEMENTS

ERROR	CAUSE	ELIMINATION
CH.DPo.	Number is too small (large negative) to be displayed	change DP setting, channel constant setting
CH.DPr.	Number is too large to be displayed	change DP setting, channel constant setting
CH.TPo.	Number is outside the table range	increase table values, change input setting (channel constant setting)
CH.TPr.	Number is outside the table range	increase table values, change input setting (channel constant setting)
CH.VPo.	Input quantity is smaller than permitted input quantity range	change input signal value or input (range) setting
CH.VPr.	Input quantity is larger than permitted input quantity range	change input signal value or input (range) setting
CH. HW.	A part of the instrument does not work properly	send the instrument for repair
CH. EE	Data in EEPROM corrupted	perform restoration of manufacture setting, upon repeated error statement send instrument for repair
CH.NAS.	Data in EEPROM outside the range	perform restoration of manufacture setting, upon repeated error statement send instrument for repair
CH.SMA.	Memory was empty (presetting carried out)	upon repeated error statement send instrument for repair, possible failure in calibration
CH.VYS.	Analogue output current loop disconnected	check wire connection

The instrument allows to add two descriptive characters to the classic numeric formats (at the expense of the number of displayed places). The setting is performed by means of a shifted ASCII code. Upon modification the first two places display the entered characters and the last two places the code of the relevant symbol from 0 to 95. Numeric value of given character equals the sum of the numbers on both axes of the table.

Description is cancelled by entering characters with code 00

	0	1	2	3	4	5	6	7		0	1	2	3	4	5	6	7
0		l	"	8	5	'	2	'	0	!	"	#	\$	%	&	'	
8	[]	H	+	,	-		2	8	()	*	+	,	-	.	/
16	0	1	2	3	4	5	6	7	16	0	1	2	3	4	5	6	7
24	8	9	=	.	c	=	3	2.	24	8	9	:	;	<	=	>	?
32	J	R	b	[d	E	F	G	32	@	A	B	C	D	E	F	G
40	H	I	J	K	L	M	N	O	40	H	I	J	K	L	M	N	O
48	P	Q	r	S	t	U	v	w	48	P	Q	R	S	T	U	V	W
56	H	Y	2	[4]	n	-	56	X	Y	Z	[\]	^	_
64	'	R	b	c	d	E	F	G	64	`	a	b	c	d	e	f	g
72	h	i	j	k	l	m	n	o	72	h	i	j	k	l	m	n	o
80	P	Q	r	S	t	u	v	w	80	p	q	r	s	t	u	v	w
88	H	Y	2	+	!	+	0		88	x	y	z	{		}	~	

11. TECHNICAL DATA

INPUT

Number:	1 input
Type:	upon contact, TTL, NPN/PNP, „Line“, SSI
Measurement:	counter/frequency UP or DOWN duty cycle counter/frequency UP/DOWN counter/frequency for IRC encoders timer/clock
Input frequency:	0,001...1 MHz (< 100 kHz for duty cycle measurement)
Voltage levels:	10 mV - 0,8 V (amplified - only input A1, (B1)) 0,8 V - 60 V
Reaction time:	inputs react approx 3 s after instrument's switch-on

ZOBRAZENÍ

Display:	999999, digit height 57, 100 or 125 mm - 3-colour 7 segment LED display red/green/orange - high brightness LEDs, red or green (1300 mcd)
Projection:	-999...9999 or -99999...999999
Decimal point:	adjustable - in menu
Brightness:	adjustable - in menu

INSTRUMENT ACCURACY

TC:	50 ppm/°C
Accuracy:	±0,01 % of range + 1 digit (Frequency)
Time base:	0,05 s...15 min.
Multiplication const.:	-99999...999999
Division constant:	-99999...999999 - function RPM measurement in mode „Frequency“
Filtration constant:	helps to set max. valid frequency, which is processed (OFF/10 minutes...1 MHz)
Blocking measur.:	blocking/extending input pulse up to 120 s
Filter type:	digital
Offset:	-99999...999999
Data back up:	storing measured data after the instrument is switched off (EEPROM)
Linearisation:	by linear interpolation in 50 points - solely via OM Link
Digital filters:	Averaging, Floating average, Exponential filter, Rounding
Functions:	Tare - display resetting Hold - stop measuring (at contact) Lock - control key locking MM - min/max value Mathematic functions
RTC:	time back up by the means of a battery used when the power supply is off (possible to turn off - jumper inside instrument) minimal lifespan 1 year
Baterie:	Lithium battery CR 2032RV, 3V/220 mAh
OM Link:	company communication interface for setting, operation and update of instrument SW
Watch-dog:	reset after 400 ms
Calibration:	at 25°C and 40% of r.h.

COMPARATORS

Type:	digital, adjustable in menu
Contact switch:	< 10 ms < 50 µs (without filtration)
Mode:	Hysteresis, From, Dose, C-Puls, Run
Limita:	-99999...999999
Hysteresis:	0...999999
Delay:	0...99,9 s
Výstupy:	4x relé se spínacím kontaktem (Form A) (250 VAC/30 VDC, 3 A)* 1/8 HP 277 VAC, 1/10 HP 125 V, Pilot Duty D300
Relé:	

DATA OUTPUTS

Protocols:	ASCII, DIN MessBus, MODBUS, PROBUS
Data format:	8 bit + no parity + 1 stop bit (ASCII) 7 bit + even parity + 1 stop bit (MessBus)
Rate:	600...230 400 Baud 9 600 Baud...12 Mbaud (PROFIBUS)
RS 232:	isolated, two-way communication
RS 485:	isolated, two-way communication, addressing (max. 31 instruments)
PROFIBUS	Data protocol SIEMENS

ANALOGUE OUTPUTS

Type:	isolated, programmable with 12 bits D/A converter, analog output corresponds with displayed data, type and range are adjustable
Non-linearity:	0,1% of range
TC:	100 ppm/°C
Rate:	response to change of value < 1 ms
Voltage:	0...2 V/5 V/10 V/± 10V
Current:	0...5/20 mA/4...20 mA - compensation of conduct to 500 Ohm/12 V or 1 000 Ohm/24 V - broken loop detection

EXCITATION

Adjustable:	5/12/17/24 VDC/max. 2,5 W, isolated
-------------	-------------------------------------

* values apply for resistance load

POWER SUPPLY

Options:

- 10...30 V AC/DC, 27 VA, isolated
 $PF \geq 0,4$, $I_{STP} > 75 A/2 ms$
 fuse inside (T 4000 mA)
- 80...250 V AC/DC, 27 VA, isolated
 $PF \geq 0,4$, $I_{STP} > 45 A/2 ms$
 fuse inside (T 630 mA)

MECHANICAL PROPERTIES

Material: anodized aluminum, black
 Dimensions: see chapter 13
 Panel cut-out: see chapter 13

OPERATING CONDITIONS

Connection: connector terminal board, conductor cross-section $<1,5 mm^2 / <2,5 mm^2$

Stabilisation period: within 15 minutes after switch-on

Working temp.: $-20^\circ \dots 60^\circ C$
 Storage temp.: $-20^\circ \dots 85^\circ C$
 Cover: IP64
 Construction: safety class I
 Overvoltage cat.: EN 61010-1, A2

Dielectric strength: 4 kVAC after 1 min between supply and input
 4 kVAC after 1 min between supply and data/analog output
 4 kVAC after 1 min between supply and relay output
 2,5 kVAC after 1 min between supply and data/analog output

Insulation resistan.: for pollution degree II, measurement category III
 instrum.power supply $> 670 V (PI)$, $300 V (DI)$
 Input/output $> 300 V (PI)$, $150 (DI)$

EMC: EN 61326-1

12. INSTRUMENT DIMENSIONS AND INSTALLATION

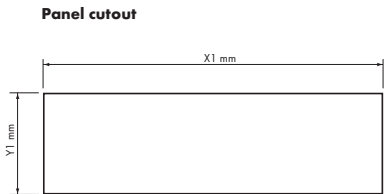
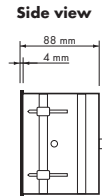
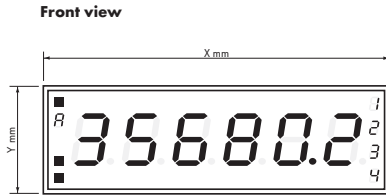

Panel thickness: 0,5 ... 50 mm

Height	X	Y	X1	Y1
57-6	375	119	367	111
100-4	465	181	457	173
100-6	651	181	643	173
125-4	539	237	531	228
125-6	754	237	746	228

Wall mounting

As a standard, large displays are designed for panel installation. Upon request we may also supply a holder for wall mounting, see picture.

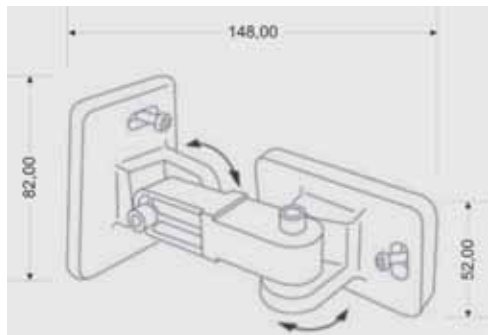



Product **OMD 202UQC**
Type
Manufacturing No.
Date of sale

A guarantee period of 60 months from the date of sale to the user applies to this instrument.
Defects occurring during this period due to manufacture error or due to material faults shall be eliminated free of charge.

For quality, function and construction of the instrument the guarantee shall apply provided that the instrument was connected and used in compliance with the instructions for use.

The guarantee shall not apply to defects caused by:

- mechanic damage
- transportation
- intervention of unqualified person incl. the user
- unavoidable event
- other unprofessional interventions

The manufacturer performs guarantee and post.guarantee repairs unless provided for otherwise.

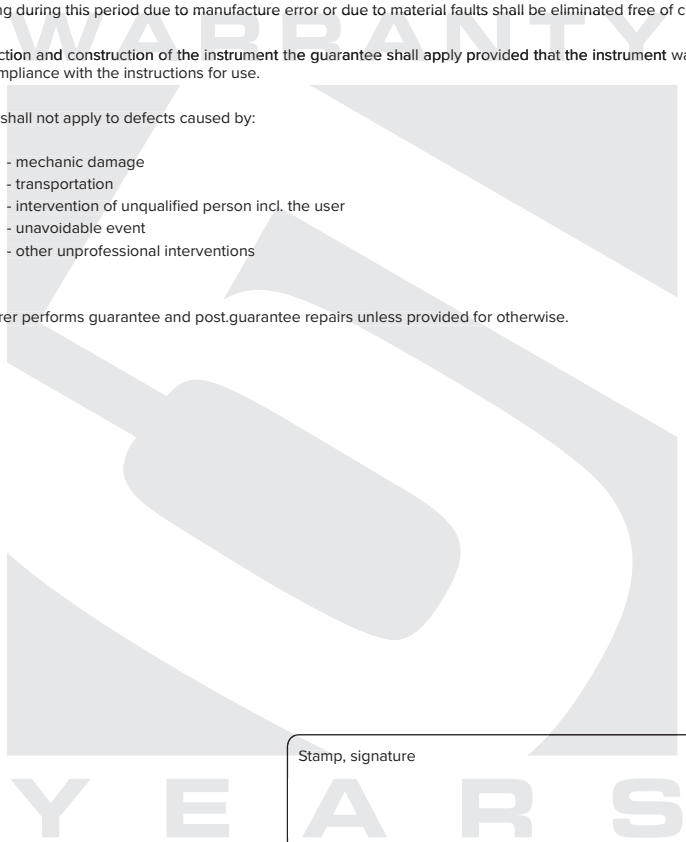

Stamp, signature

NOTE



Company ORBIT MERRET, spol. s r.o.
Klánská 81/141, 142 00 Prague 4, Czech Republic, IDNo.: 00551309

Manufactured ORBIT MERRET, spol. s r.o.
Vodňanská 675/30, 198 00 Prague 9, Czech Republic

declares at its explicit responsibility that the product presented hereunder meets all technical requirements, is safe for use when utilised under the terms and conditions determined by ORBIT MERRET, spol.s r.o. and that our company has taken all measures to ensure conformity of all products of the types referred-to hereunder, which are being brought out to the market, with technical documentation and requirements of the appurtenant Czech statutory orders.

Product 4/6-digit programmable large display

Type OMD 202

Version UNI, PWR, UQC, RS

This has been designed and manufactured in line with requirements of

Low-voltage electrical equipment (directive no. 2014/35/EU)

Electromagnetic compatibility (directive no. 2014/30/EU)

The product qualities are in conformity with harmonized standard

El. safety: EN 61010-1

EMC: EN 61326-1

Electronic measuring, control and laboratory devices – Requirements for EMC “Industrial use”

EN 50131-1, cap. 14 and cap. 15, EN 61000-4-2, EN 61000-4-3, EN 61000-4-4, EN 61000-4-5, EN 61000-4-6, EN 61000-4-8, EN 61000-4-11, EN 61000-3-2, EN 61000-3-3, EN 55022, cap. 5 and cap. 6

The product is furnished with CE label issued in 2001.

As documentation serve the protocols of authorized and accredited organizations

EMC VTÚE Praha, experimental laboratory No. 1158, protocol No. 08-041/2001 of 24/11/2001
VTÚPV Vyškov, experimental laboratory No. 1103, protocol No. 730-325/2001 of 02/05/2001
VTÚPV Vyškov, experimental laboratory No. 1103, protocol No. 730-350/2001 of 07/05/2001
VTÚPV Vyškov, experimental laboratory No. 1103, protocol No. 730-372/2001 of 02/05/2001
VTÚPV Vyškov, experimental laboratory No. 1103, protocol No. 730-934/2001 of 20/11/2001

Place and date of issue: Prague, 19. Juli 2009

Miroslav Hackl
Company representative



ORBIT MERRET, spol. s r. o.
Vodňanská 675/30
198 00 Praha 9
Czech Republic

tel.: +420 281 040 200
fax.: +420 281 040 299
e-mail: orbit@merret.eu

www.orbit.merret.eu

